



a member of **DAIKIN** group

ROTEX



E-Pac

DVCPLT 5X

 14 10 61





E-Pac / DVCPLT 5X

14 10 61

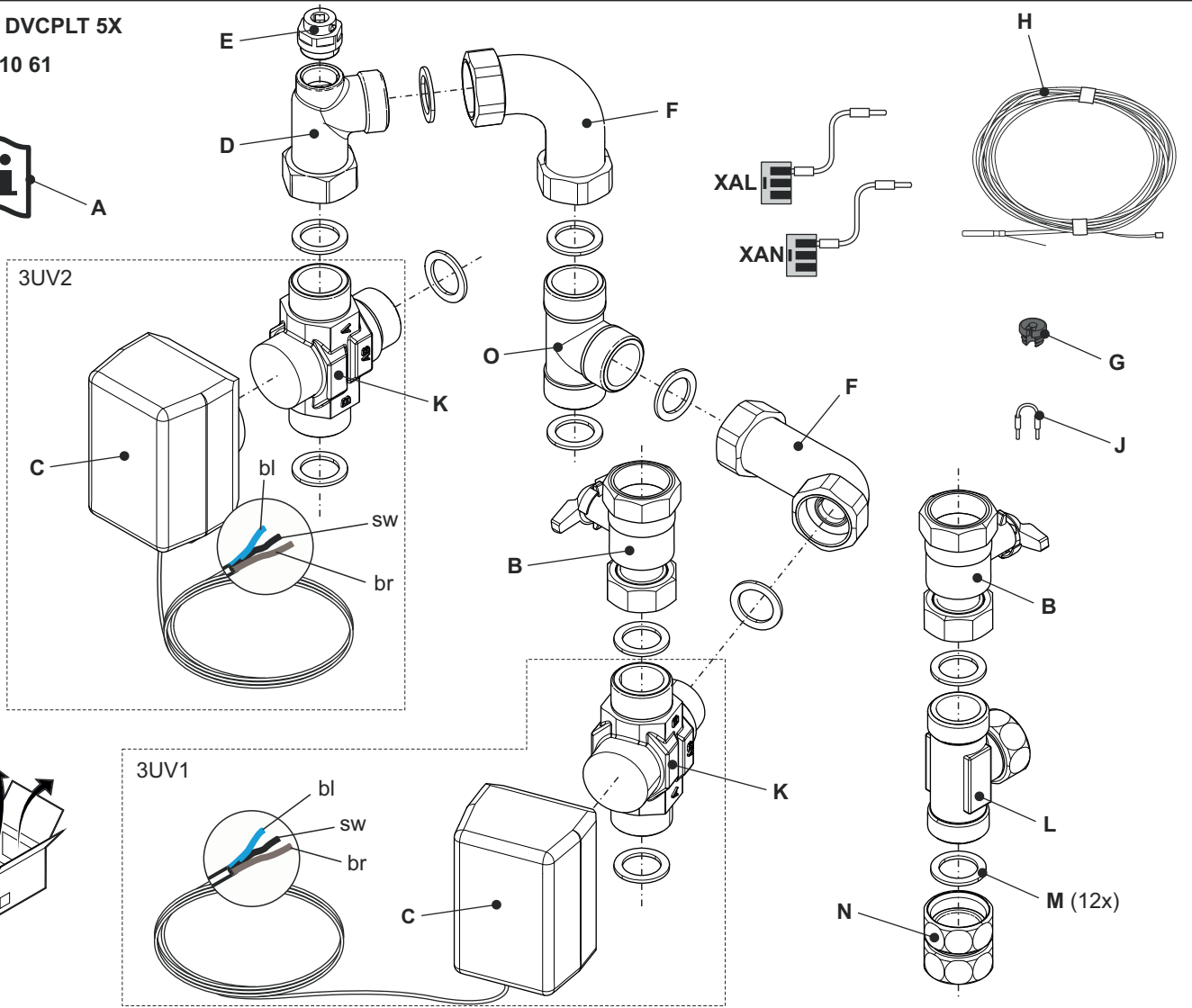

	GB	DE, AT, CH	BE, NL	IT	ES	FR
A	Documentation	Dokumentation	Documentatie	Documentazione	Documentación	Documentation
B	Ball valve 1"	Kugelhahn 1"	Kogelkraan 1"	Valvola a sfera 1"	Válvula de bola 1"	Robinet à boisseau sphérique 1"
C	Actuator switch valve	Antrieb Umschaltventil	Actuator schakelklep	Attuatore valvola	Actuador válvula	Moteur vanne d'inversion
D	Angle bracket 1"	Winkel 1"	Hoeksteun 1"	Angolare 1"	Codo 1"	Coude 1"
E	Manuel vent	Handentlüfter	Manuele ontluchter	Disareatore	Purgador manual	Purgeur manuel
F	Corrugated pipe	Wellrohr	Gedolfdepijp	Tubo corrugato	Tubo corrugado	Tube annelé
G	Sensor plug	Fühlerstopfen	Sensor plug	Connettore sonda	Tapón del sensor	Bouchon sonde
H	Storage tank sensor	Speicherfühler	Opslagtank sensor	Sensore accumulo	Sonda ACS	Sonde ballon
J	STB-Bridge	STB-Brücke	STB-brug	STB-Ponte	STB-Puente	STB-pont
K	Switching valve 1"	Umschaltventil 1"	Omschakelklep 1"	Valvola deviatrice 1"	Válvula de conmutación 1"	Vanne d'inversion 1"
L	T-pipe 1"	T-Stück 1"	T-pijp 1"	Raccordo T 1"	Racor "TE" 1"	Raccord en T 1"
M	Flat seal 1"	Flachdichtung 1"	Vlakke dichting 1"	Guarnizione piana 1"	Junta plana 1"	Joint plat 1"
N	Connection pipe 1"	Verbindungsstück 1"	Aansluitleiding 1"	Tubo di connessione 1"	Racor de conexión 1"	Raccord de connexion 1"
O	T-pipe 1"	T-Stück 1"	T-pijp 1"	Raccordo T 1"	Racor "TE" 1"	Raccord en T 1"
XAL XAN	Connector actuator	Verbindungsklemme Antrieb	Aansluiting actuator	Collegamento Attuatore	Conexión actuador	Connexion Moteur
br	brown	braun	bruin	marrone	marrón	marron
sw	black	schwarz	zwart	nero	negro	noir
bl	blue	blau	blauw	blu	azul	bleu

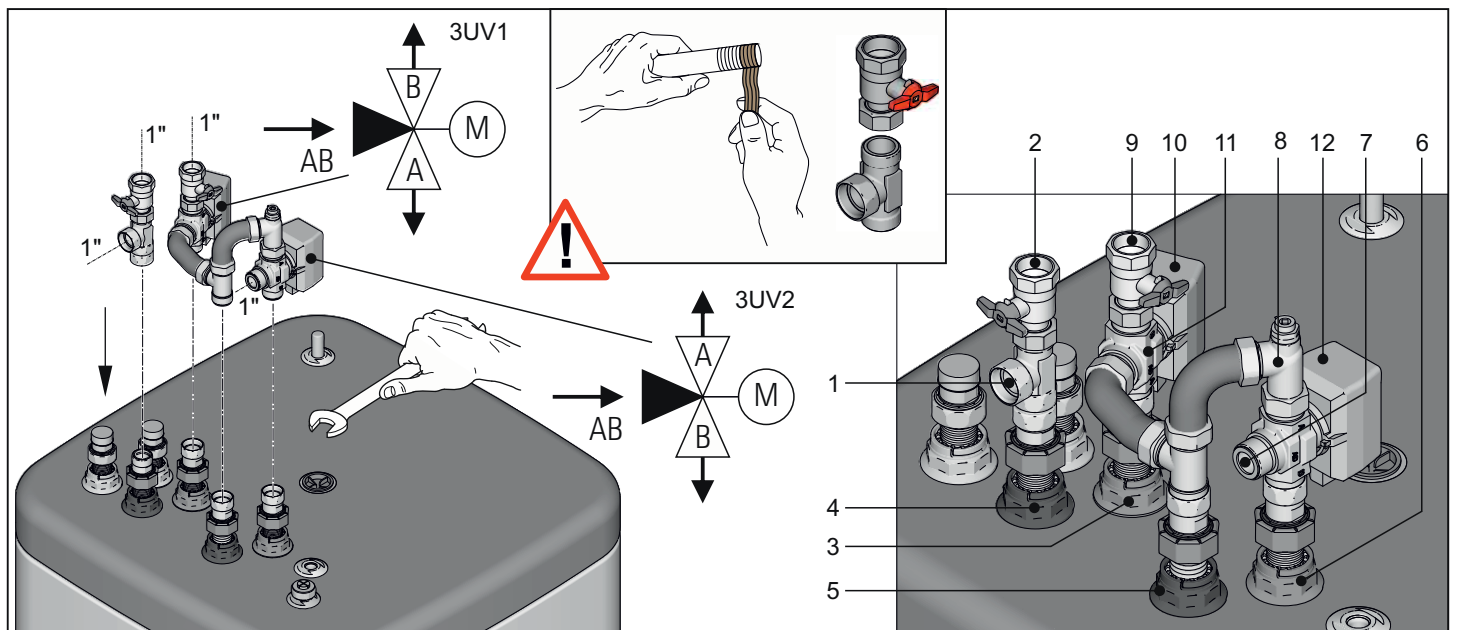
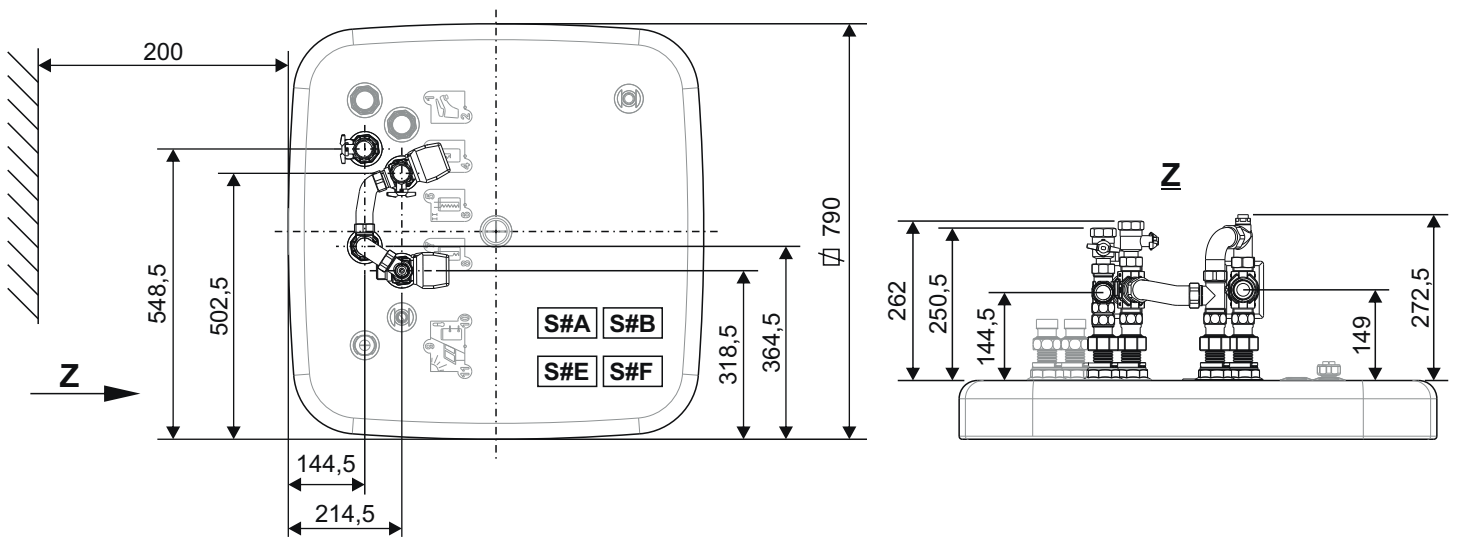

	GB	DE, AT, CH	BE, NL	IT	ES	FR
1	Return HPSU	Rücklauf HPSU	Terugkeer HPSU	Ritorno HPSU	Retorno HPSU	Retour HPSU
2	Return central heating	Rücklauf Heiznetz	Terugkeer centrale verwarming	Ritorno rete di riscaldamento	Retorno red de calefacción	Retour réseau de chauffage
3	Flow storage tank charging	Speicherladung Vorlauf	Stroom opslagtank laden	Mandata caricamento del bollitore	Carga del acumulador, impulsión	Charge du ballon départ
4	Return storage tank charging	Speicherladung Rücklauf	Terugkeer obslagtank laden	Ritorno caricamento del bollitore	Carga del acumulador, retorno	Charge du ballon retour
5	Return heating support	Heizungsunterstützung Rücklauf	Terugkeer hulpverwarming	Ritorno riscaldamento ausiliario	Apoyo calefacción, retorno	Appoint de chauffage retour
6	Flow heating support	Heizungsunterstützung Vorlauf	Stroom hulpverwarming	Mandata riscaldamento ausiliario	Apoyo calefacción, impulsión	Appoint de chauffage départ
7	Flow HPSU	Vorlauf HPSU	Stroom HPSU	Mandata HPSU	Impulsión HPSU	Départ HPSU
8	Angle bracket with manual vent	Winkel mit Handentlüfter	Hoeksteen met manuele ontlufter	Angolare con sfiatatoio manuale	Codo con purgador de aire manual	Equerre avec purge manuelle
9	Flow central heating	Vorlauf Heiznetz	Stroom centrale verwarming	Mandata rete riscaldamento	Impulsión red de calefacción	Départ réseau de chauffage
10 3UV1 12 3UV2	3-way switch valve	3-Wege-Umschalt-ventil	3-weg omschakelkleb	Valvola selettoria a 3 vie	Válvula de conmutación de 3 vías	Vanne d'inversion 3-voies
11	Valve body	Ventilkörper	Kleplichaam	Corpo valvola	Cuerpo de la válvula	Corps de vanne
S#A S#B S#E S#F	Hybridcube storage tank (500 l) HYC 544/19/0-DB HYC 544/32/0-DB HYC 544/19/0-P HYC 544/32/0-P	Hybridcube Wärmespeicher (500 l)	Hybridcube Warmwaterboiler (500 l)	Hybridcube Bollitore ad accumulo (500 l)	Hybridcube Acumulador de ACS (500 l)	Réservoir d'eau chaude (500 l)

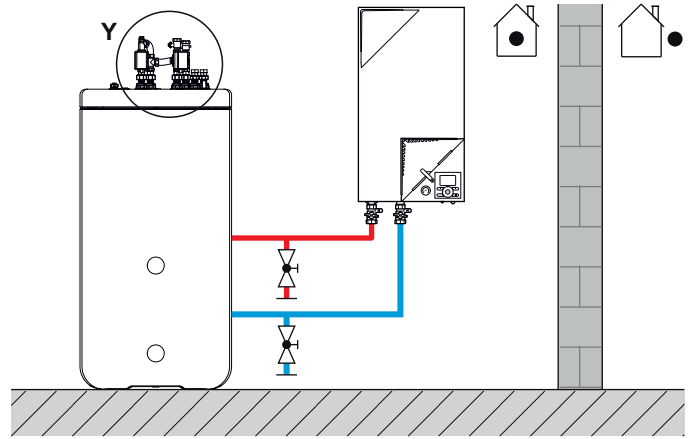
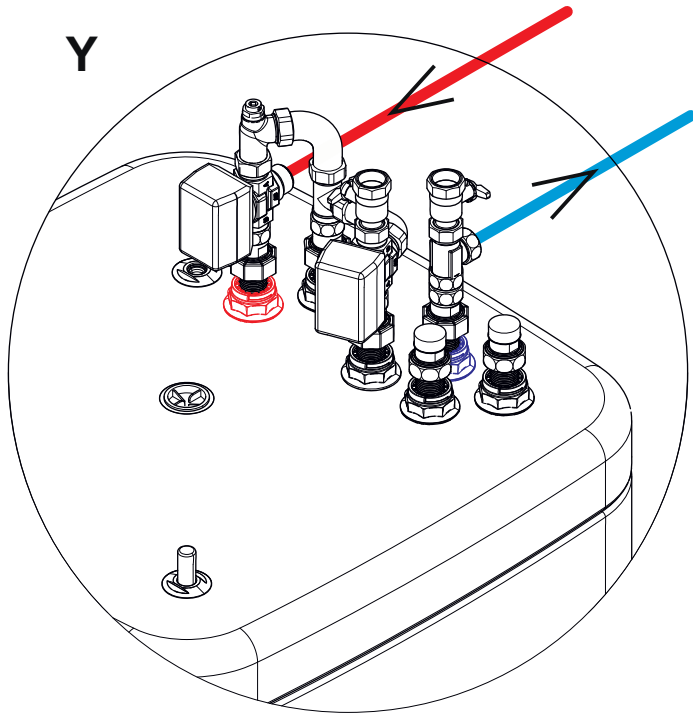

RHBX

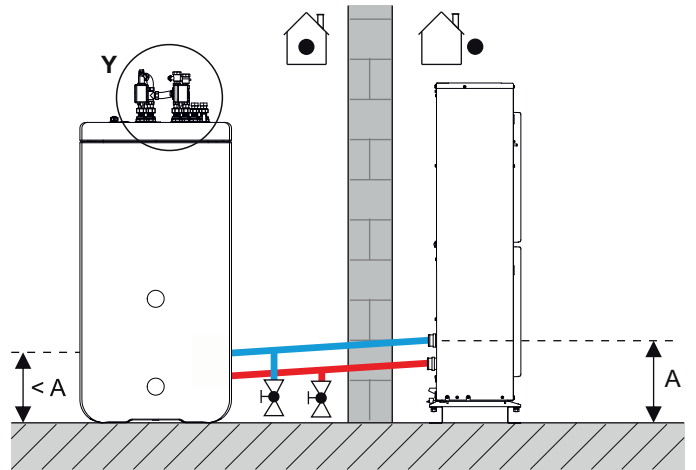

RBLQ

⚡

DE Warnung: Lebensgefahr durch Hochspannung!
GB Warning: Danger to life - high voltage!
IT Avvertenza: Pericolo di morte per alta tensione!
FR Avertissement: Danger de mort - Haute tension!
BE Waarschuwing: Levensgevaar door hoogspanning!
ES Advertencia: Peligro de muerte por alta tensión!

DE Vor Öffnen alle Stromkreise spannungsfrei schalten.
GB Before opening switch off all voltage circuits
IT Prima di aprire i circuiti elettrici togliere la tensione.
FR Mettre hors tension tous les circuits électriques avant ouverture.
BE Voor het openen, alle stroomkringen spanningsvrij maken.
ES Desconectar todos los circuitos de la alimentación eléctrica antes de abrir.

007.15 161 99_01

**ROTEX HybridCube
+
ROTEX HPSU Bi-Bloc
ROTEX HPSU monobloc**

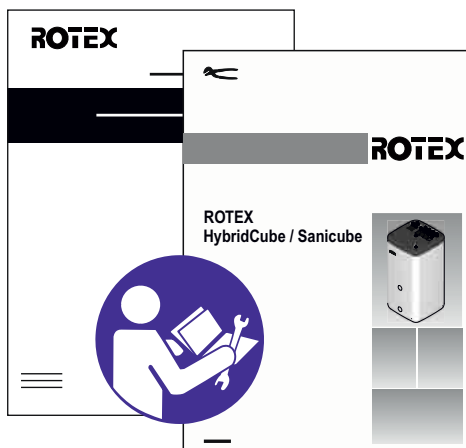

www.rotex-heating.com

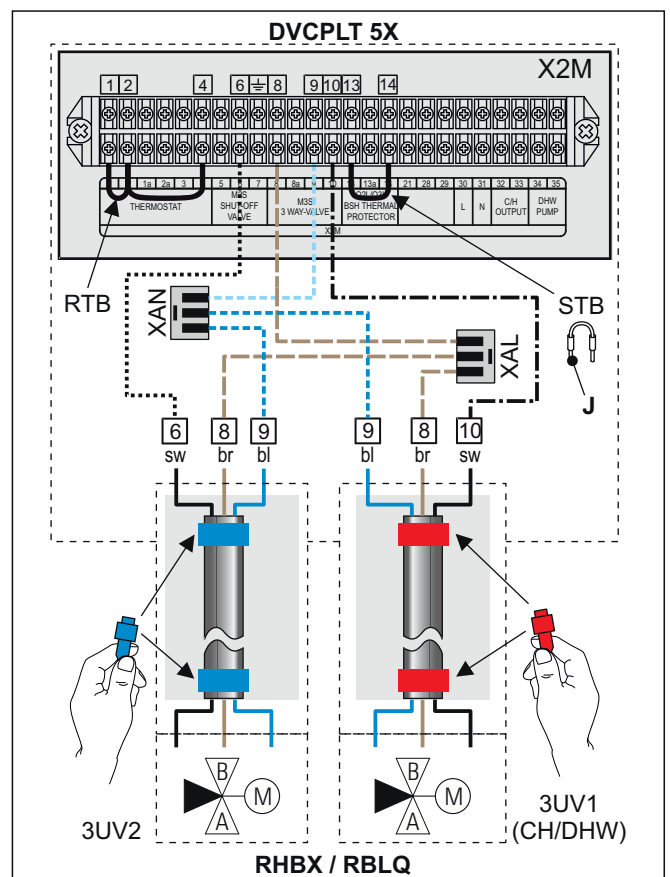

br	brown	braun	bruin	marrone	marrón	marron
sw	black	schwarz	zwart	nero	negro	noir
bl	blue	blau	blauw	blu	azul	bleu



RHBX

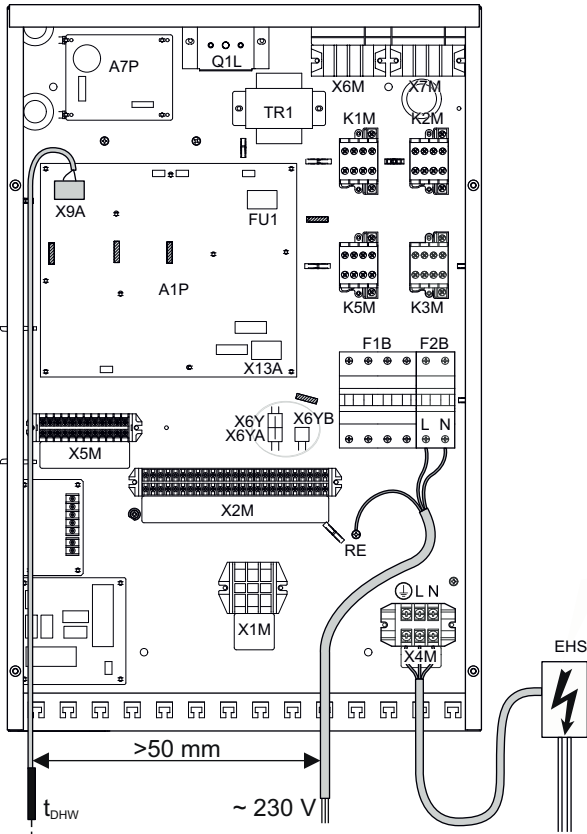

RBLQ

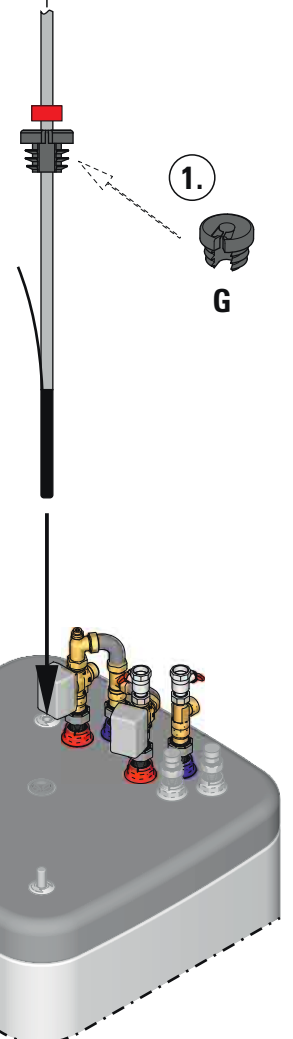
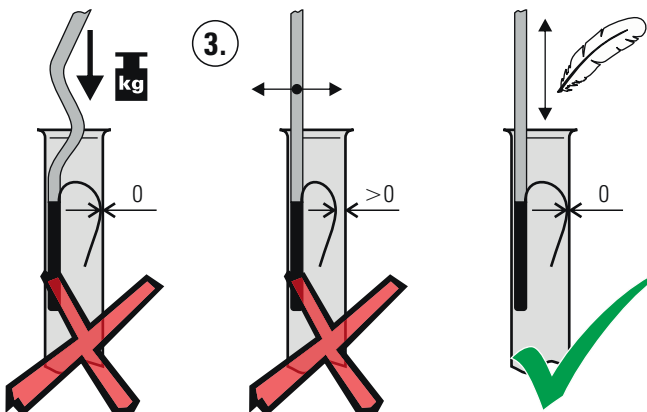
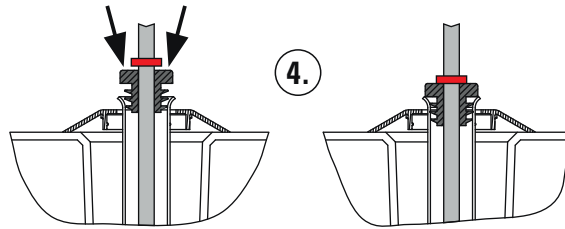
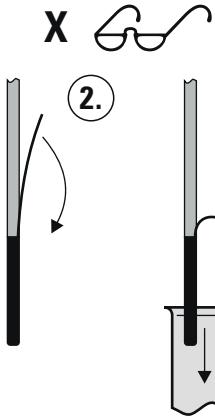
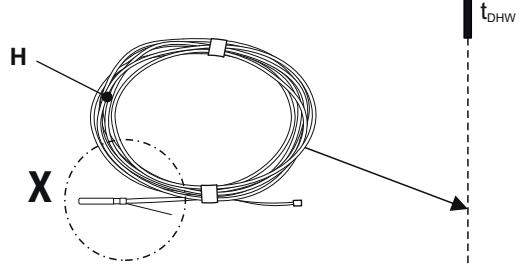
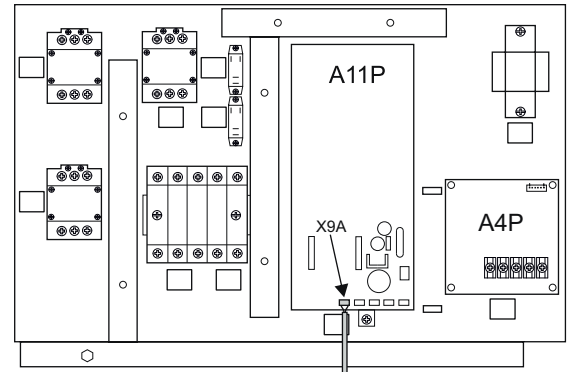



Hydraulic connection / Hydraulische Anbindung / Hydraulische aansluiting /
Collegamento idraulico / Unión hidráulica / Système hydraulique

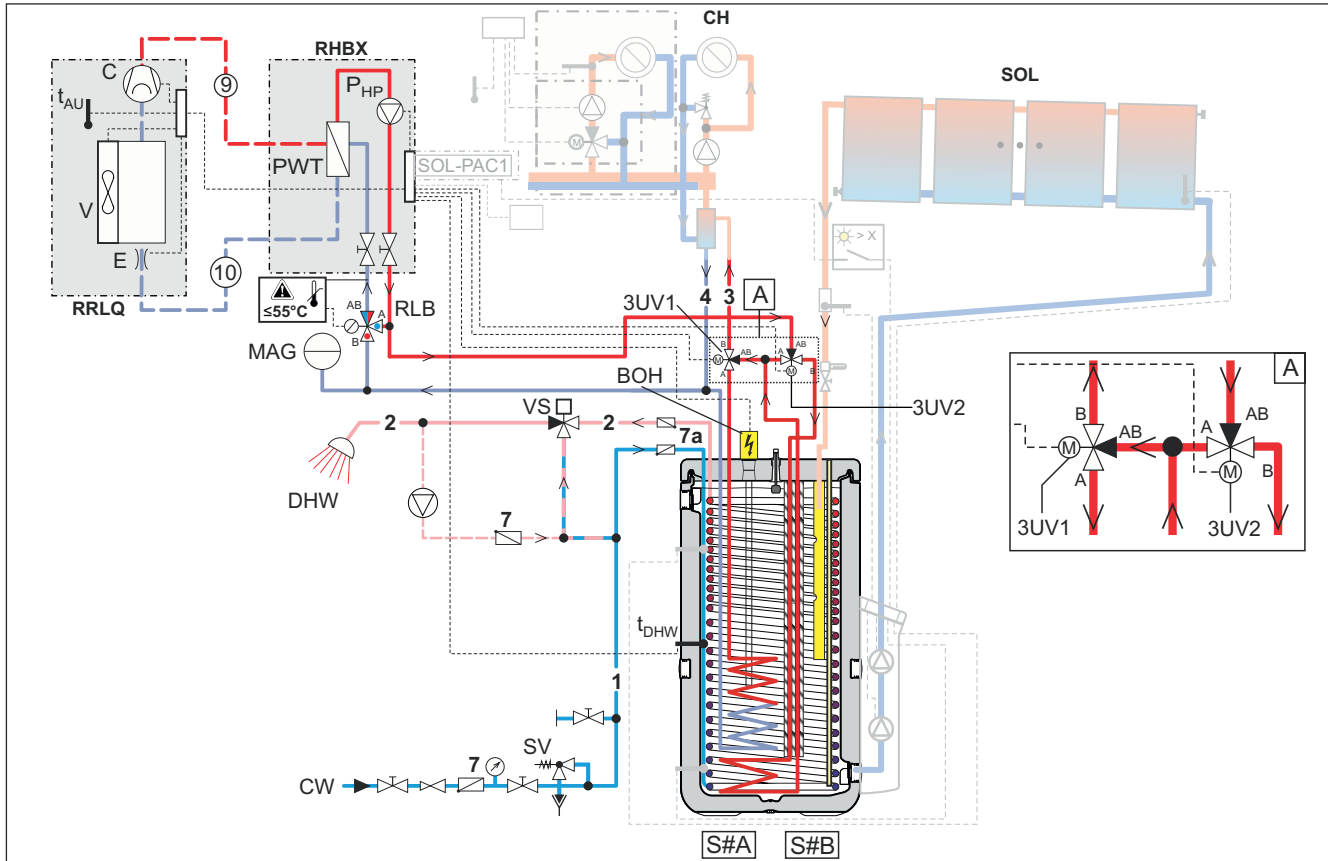

RHBX + DVCPLT 5X

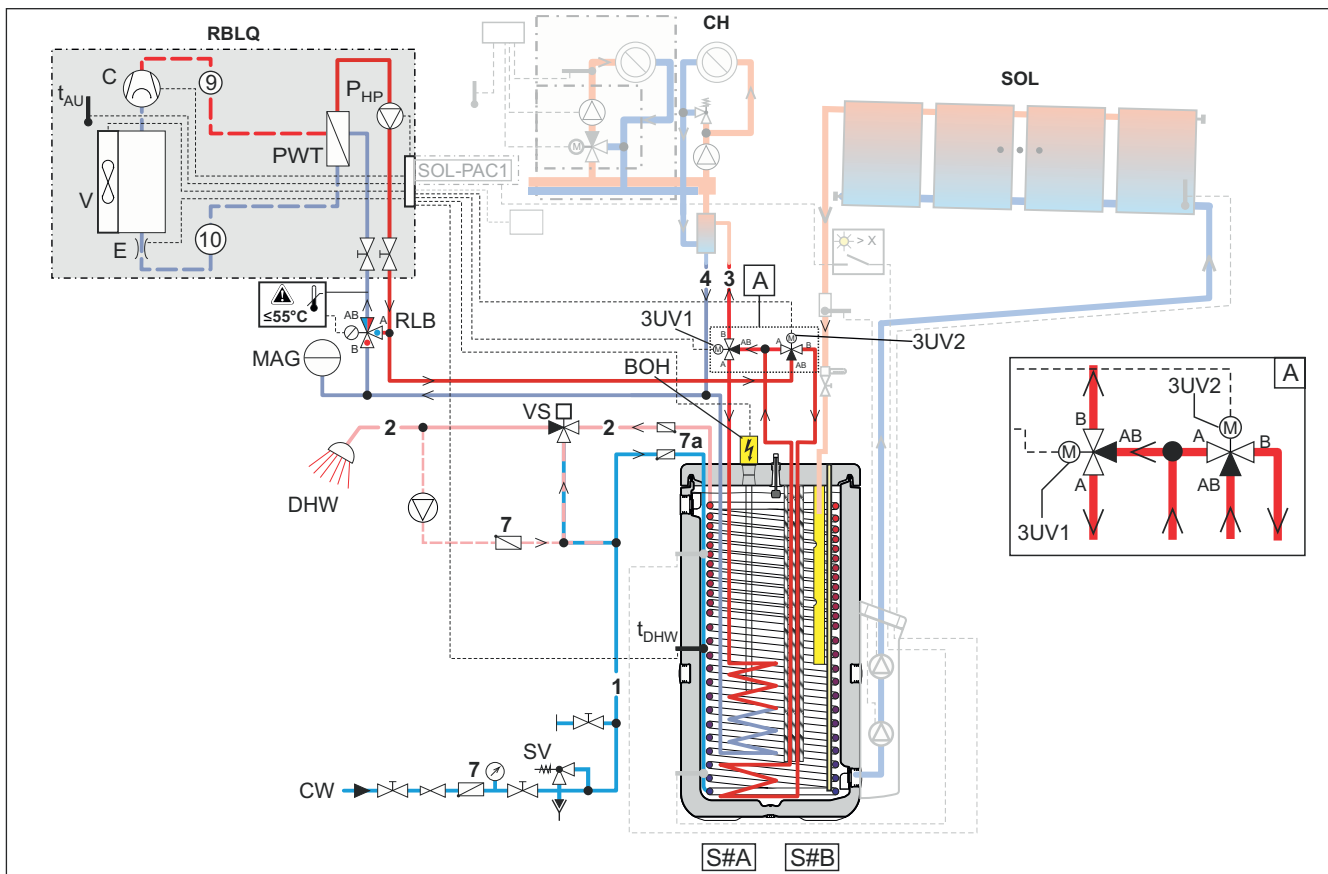

RBLQ + DVCPLT 5X



	GB	DE, AT, CH	BE, NL	IT	ES	FR
1	Cold water flow	Kaltwasserleitung	Koudwater-distributienet	Rete di distribuzione dell'acqua fredda	Red de distribución de agua fría	Réseau de distribution de l'eau froide
2	Hot water flow	Warmwasserleitung	Warmwater-distributienet	Rete di distribuzione dell'acqua calda	Red de distribución de agua caliente	Réseau de distribution d'eau chaude
3	Heating flow	Heizung Vorlauf	Verwarming aanvoer	Mandata riscaldamento	Impulsión calefacción	Départ chauffage
3UV1 3UV2	3-way-switch-valve (3UV1 / DHW) (3UV2 / cooling)	3-Wege Umschaltventil (3UV1 / DHW) (3UV2 / Kühlen)	3-wegs omschakelklep (3UV1 / DHW) (3UV2 / koelen)	Valvolaa 3 vie (3UV1 / DHW) (3UV2 / raffreddamento)	Válvula de conmutación de 3 vías (3UV1 / DHW) (3UV2 / refrigeración)	Soupape d'inversion à 3 voies (3UV1 / DHW) (3UV2 / refroid.)
4	Heating return	Heizung Rücklauf	Verwarming terugloop	Ritorno riscaldamento	Retorno calefacción	Retour chauffage
7	Check valve	Rückschlagklappe, Rückflussverhinderer	Terugslagklep, voorkomt terugstroming	Valvola di non ritorno a farfalle, valvola antiritorno	Clapeta antirretorno, inhibidor de reflujo	Clapet anti-retour
7a	Non return valve	Zirkulationsbremsen SKB (Zubehör)	Circulatieremmen	Valvole di ritegno	Válvulas de retención	Clapets anti-thermosiphon
9	Gas pipe (refrigerant)	Gasleitung (Kältemittel)	Gasleiding (koelmiddel)	Tubatura del gas (refrigerante)	Línea de gas (refrigerante)	Conduite de gaz (fluide frigorigène)
10	Fluid pipe (refrigerant)	Flüssigkeitsleitung (Kältemittel)	Vloeistofleiding (koelmiddel)	Tubatura del liquido (refrigerante)	Línea de líquido (refrigerante)	Conduite de liquide (fluide frigorigène)
BOH	Booster Heater	Booster Heater	Booster Heater	Booster Heater	Booster Heater	Booster Heater
C	Refrigerant compressor	Kompressor, Kältemittelverdichter	Koelmiddelcompressor	Compressore refrigerante	Compresor del agente refrigerante	Compresseur de réfrigérant
CH	Central heating	Heizungsnetz	Verwarming	Riscaldamento	Calefacción	Chauffage
CW	Cold Water	Kaltwasser	Koud tapwater	Acqua fredda	Agua fría	Eau froide
DHW	Domestic hot water	Warmwasser	Warmwater	Acqua calda	Agua caliente sanitaria	Eau chaude
E	Expansion valve	Expansionsventil	Expansieklep	Valvola di espansione	Válvula de expansión	Eau chaude
MAG	Diaphragm expansion vessel	Membran-ausdehnungsgefäß	Membraan-expansievat	Vso di espansione a membrana	Depósito de expansión de membrana	Vase d'expansion à membrane
P _{HP}	Circulation pump CH	Heizungsumwälz-pumpe	Circulatiepomp verwarming	Pompa di circolazione riscaldamento	Bomba de circulación de la calefacción	Pompe de recirculation de chaleur
PWT	Panel heat exchanger (condenser)	Platten-wärmetauscher (Kondensator)	Plaatwarmtewisselaar (condensator)	Scambiatore di calore a piastre condensatore)	Intercambiador de calor de placa (condensador)	Échangeur de chaleur à plaques (condensateur)
RLB	Return temperature limiter	Rücklauf-temperaturbegrenzer	Temperatuurbegrenzer retourleiding	Limitatore temperatura di ritorno	Limitador de temperatura de retorno	Limiteur de température de retour
SOL	Solar system	Solarsystem	Zonne-energiesysteem	Sistema solare	Sistema solar	Système solaire
SV	Safety overpressure valve	Sicherheits-Überdruckventil	Veiligheids-overdrukklep	Valvola di sicurezza contro sovrappressioni	Válvula de sobrepresión de seguridad	Vanne de surpression de sécurité
t _{AU}	Exterior temperature sensor	Aussentemperatur-fühler	Buitentemperatuur-sensor	Sonda di temperatura esterna	Sensor de temperatura exterior	Sonde de température extérieure
t _{DHW}	Storage tank temperature sensor	Speichertemperatur-fühler (Wärmeerzeuger)	Opslagtemperatuur-sensor (warmteopwekker)	Sonda di temperatura del bollitore	Sensor de temperatura de acumulador	Sonde de température de l'accumulateur
V	Fan (vaporiser)	Ventilator, Verdampfer	Ventilator (verdampfer)	Ventilatore (Evaporatore)	Ventilador (vaporizador)	Ventilateur (évaporateur)
VS	Burns guard VTA 32	Verbrühschutz (z. B. VTA 32)	Verbrandings-beveiliging VT A32	Miscelatore termostatico VTA32	Protección contra la escaldadura VTA32	Protection contre l'échaudure VTA32
S#A S#B	Hybridcube storage tank HYC 544/19/0-DB HYC 544/32/0-DB (500 l)	Hybridcube Wärmespeicher HYC 544/19/0-DB HYC 544/32/0-DB (500 l)	Hybridcube Warmwaterboiler HYC 544/19/0-DB HYC 544/32/0-DB (500 l)	Hybridcube Bollitore ad accumulo HYC 544/19/0-DB HYC 544/32/0-DB (500 l)	Hybridcube Acumulador de ACS HYC 544/19/0-DB HYC 544/32/0-DB (500 l)	Réservoir d'eau chaude HYC 544/19/0-DB HYC 544/32/0-DB (500 l)
RRLQ	HPSU outdoor unit	HPSU Außengerät	HPSU warm-tepompbuitentoestel	HPSU pompa di calore esterna	HPSU aparato exterior	HPSU appareil externe de pompe à chaleur
RBLQ	ROTEX HPSU monobloc (H/C)	ROTEX HPSU monobloc (H/C)	ROTEX HPSU monobloc (H/C)	ROTEX HPSU monobloc (H/C)	ROTEX HPSU monobloc (H/C)	ROTEX HPSU monobloc (H/C)
RHBX	HPSU indoor unit (H/C)	HPSU Innengerät (Heizen + Kühlen)	HPSU binneneunit (H/C)	HPSU unità interna (H/C)	HPSU aparato interior (H/C)	HPSU appareil interne (chauffer/refroid.)



Technical data / Technische Daten / Technische gegevens / Dati tecnici / Datos técnicos / Caractéristiques Techniques

Switch valve / Umschaltventil / Omschakelkleb / Valvola seletttrice / Válvula de conmutación / Vanne d'inversion	
Operating voltage / Betriebsspannung / Bedrijfsspanning / Tensione d'esercizio / Tensión de servicio / Tension de fonctionnement	230 V / 50 Hz
Maximum power input / Maximale Leistungsaufnahme / Maximale vermogensopname / Potenza assorbita massima / Absorción de máxima / Puissance absorbée maximum	4,3 W
Protection type / Schutzart / Beschermingklasse / Grado di protezione / Grado de protección / Type de protection	IP 40
Turnaround time / Umschaltzeit / Omschakeltijd / Tempo di commutazione / Tiempo de conmutación / Temps d'inversion	6s
KVS-coefficient / KVS-Wert / KVS-coëfficiënt / KVS-Coefficiente / KVS-coeficiente / KVS-valeur	7,7

Storage tank sensor / Speicherfühler / Opslagtank sensor / Sensore accumulo / Sonda ACS / Sonde ballon

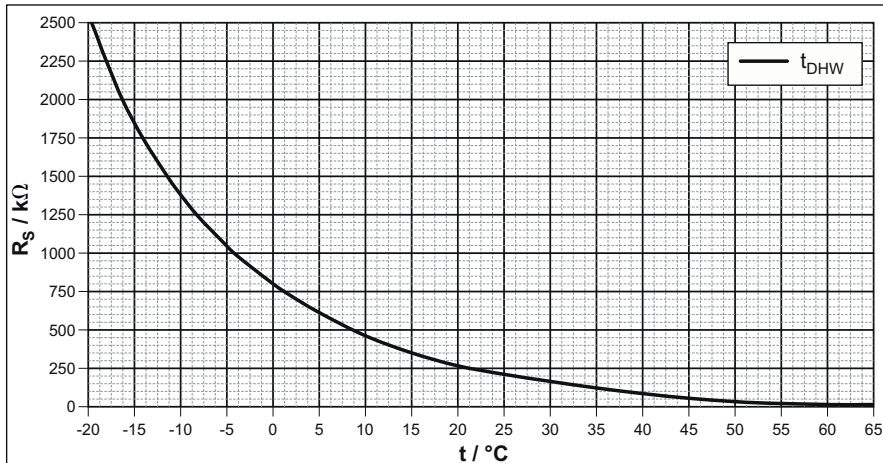

Resistance characteristics /
Widerstandskennlinie /
Weerstandskarakteristiek /
Linea carrateristica /
Curva característica /
Caractéristiques de résistance

RHBX / RBLQ + DVCPLT 5X

a member of **DAIKIN** group

ROTEX

ROTEX Heating Systems GmbH
Langwiesenstraße 10
D-74363 Güglingen
www.rotex-heating.com