

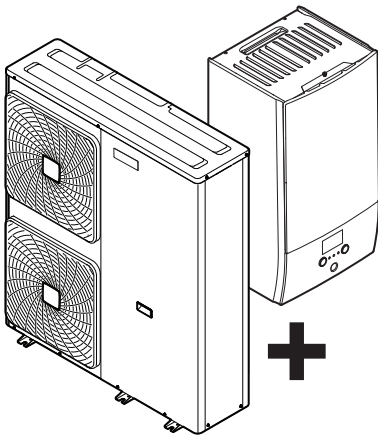

Installer reference guide

Daikin Altherma 3 H W



EPGA11DAV3(7)
EPGA14DAV3(7)
EPGA16DAV3(7)

EABH16DF6V
EABH16DF9W

EABX16DF6V
EABX16DF9W

Table of contents

1	About this document	6
1.1	Meaning of warnings and symbols	7
1.2	Installer reference guide at a glance	8
2	General safety precautions	10
2.1	For the installer	10
2.1.1	General	10
2.1.2	Installation site	11
2.1.3	Refrigerant — in case of R410A or R32	11
2.1.4	Water	13
2.1.5	Electrical	13
3	Specific installer safety instructions	16
4	About the box	21
4.1	Overview: About the box	21
4.2	Outdoor unit	21
4.2.1	To unpack the outdoor unit	21
4.2.2	To handle the outdoor unit	22
4.2.3	To remove the accessories from the outdoor unit	22
4.2.4	To remove the transportation stay	23
4.3	Indoor unit	24
4.3.1	To unpack the indoor unit	24
4.3.2	To remove the accessories from the indoor unit	24
5	About the units and options	26
5.1	Overview: About the units and options	26
5.2	Identification	26
5.2.1	Identification label: Outdoor unit	26
5.2.2	Identification label: Indoor unit	26
5.3	Combining units and options	27
5.3.1	Possible options for the outdoor unit	27
5.3.2	Possible options for the indoor unit	27
5.3.3	Possible combinations of indoor unit and outdoor unit	29
5.3.4	Possible combinations of indoor unit and domestic hot water tank	29
6	Application guidelines	30
6.1	Overview: Application guidelines	30
6.2	Setting up the space heating/cooling system	30
6.2.1	Single room	31
6.2.2	Multiple rooms – One LWT zone	35
6.2.3	Multiple rooms – Two LWT zones	39
6.3	Setting up an auxiliary heat source for space heating	41
6.4	Setting up the domestic hot water tank	44
6.4.1	System layout – Integrated DHW tank	44
6.4.2	System layout – Standalone DHW tank	44
6.4.3	Selecting the volume and desired temperature for the DHW tank	45
6.4.4	Setup and configuration – DHW tank	46
6.4.5	DHW pump for instant hot water	47
6.4.6	DHW pump for disinfection	47
6.4.7	DHW pump for tank preheating	48
6.5	Setting up the energy metering	48
6.5.1	Produced heat	49
6.5.2	Consumed energy	49
6.5.3	Normal kWh rate power supply	50
6.5.4	Preferential kWh rate power supply	51
6.6	Setting up the power consumption control	52
6.6.1	Permanent power limitation	53
6.6.2	Power limitation activated by digital inputs	53
6.6.3	Power limitation process	55
6.7	Setting up an external temperature sensor	56
7	Unit installation	57
7.1	Preparing the installation site	57
7.1.1	Installation site requirements of the outdoor unit	57
7.1.2	Additional installation site requirements of the outdoor unit in cold climates	60

7.1.3	Installation site requirements of the indoor unit	60
7.2	Opening and closing the units	61
7.2.1	About opening the units.....	61
7.2.2	To open the outdoor unit.....	62
7.2.3	To remove the transportation stay	62
7.2.4	To close the outdoor unit.....	63
7.2.5	To open the indoor unit	63
7.2.6	To close the indoor unit	65
7.3	Mounting the outdoor unit.....	65
7.3.1	About mounting the outdoor unit	65
7.3.2	Precautions when mounting the outdoor unit	66
7.3.3	To provide the installation structure	66
7.3.4	To install the outdoor unit	66
7.3.5	To provide drainage.....	67
7.4	Mounting the indoor unit	68
7.4.1	About mounting the indoor unit	68
7.4.2	Precautions when mounting the indoor unit.....	68
7.4.3	To install the indoor unit	68
7.4.4	To connect the drain hose to the drain	69
8	Piping installation	70
8.1	Preparing water piping	70
8.1.1	Water circuit requirements.....	70
8.1.2	Formula to calculate the expansion vessel pre-pressure.....	73
8.1.3	To check the water volume and flow rate	73
8.1.4	Changing the pre-pressure of the expansion vessel.....	76
8.1.5	To check the water volume: Examples	76
8.2	Connecting water piping.....	77
8.2.1	About connecting the water piping	77
8.2.2	Precautions when connecting the water piping.....	77
8.2.3	To connect the water piping	77
8.2.4	To fill the water circuit	79
8.2.5	To protect the water circuit against freezing	80
8.2.6	To fill the domestic hot water tank.....	83
8.2.7	To insulate the water piping	83
9	Electrical installation	84
9.1	About connecting the electrical wiring	84
9.1.1	Precautions when connecting the electrical wiring.....	84
9.1.2	Guidelines when connecting the electrical wiring.....	85
9.1.3	About electrical compliance.....	86
9.1.4	About preferential kWh rate power supply.....	86
9.1.5	Overview of electrical connections except external actuators	87
9.2	Connections to the outdoor unit.....	87
9.2.1	To connect the electrical wiring to the outdoor unit	87
9.3	Connections to the indoor unit	89
9.3.1	To connect the main power supply.....	89
9.3.2	To connect the backup heater power supply	90
9.3.3	To connect the shut-off valve	92
9.3.4	To connect the electricity meters	93
9.3.5	To connect the domestic hot water pump	93
9.3.6	To connect the alarm output	94
9.3.7	To connect the space cooling/heating ON/OFF output.....	94
9.3.8	To connect the changeover to external heat source.....	95
9.3.9	To connect the power consumption digital inputs.....	95
9.3.10	To connect the safety thermostat (normally closed contact)	96
9.3.11	To connect a Smart Grid.....	96
10	Configuration	99
10.1	Overview: Configuration	99
10.1.1	To access the most used commands	100
10.2	Configuration wizard.....	102
10.3	Possible screens	103
10.3.1	Possible screens: Overview	103
10.3.2	Home screen.....	104
10.3.3	Main menu screen.....	106
10.3.4	Menu screen	107
10.3.5	Setpoint screen.....	107
10.3.6	Detailed screen with values	108
10.3.7	Schedule screen: Example.....	108

10.4	Weather-dependent curve	113
10.4.1	What is a weather-dependent curve?	113
10.4.2	2-points curve.....	113
10.4.3	Slope-offset curve.....	114
10.4.4	Using weather-dependent curves.....	116
10.5	Settings menu	118
10.5.1	Malfunctioning	118
10.5.2	Room.....	118
10.5.3	Main zone	121
10.5.4	Additional zone.....	130
10.5.5	Space heating/cooling	134
10.5.6	Tank.....	142
10.5.7	User settings.....	143
10.5.8	Information.....	147
10.5.9	Installer settings	148
10.5.10	Commissioning	166
10.5.11	User profile	166
10.5.12	Operation.....	166
10.6	Menu structure: Overview user settings.....	167
10.7	Menu structure: Overview installer settings.....	168
11	Commissioning	169
11.1	Overview: Commissioning	169
11.2	Precautions when commissioning.....	169
11.3	Checklist before commissioning.....	170
11.4	Checklist during commissioning	171
11.4.1	To check the minimum flow rate	171
11.4.2	Air purge function.....	171
11.4.3	To perform an operation test run	173
11.4.4	To perform an actuator test run	173
11.4.5	Possible actuator test runs.....	174
11.4.6	Underfloor heating screed dryout	174
12	Hand-over to the user	178
13	Maintenance and service	179
13.1	Overview: Maintenance and service	179
13.2	Maintenance safety precautions.....	179
13.3	Checklist for yearly maintenance of the outdoor unit.....	179
13.4	Checklist for yearly maintenance of the indoor unit	179
13.5	About cleaning the water filter in case of trouble	182
13.5.1	To remove the water filter	182
13.5.2	To clean the water filter in case of trouble.....	182
13.5.3	To install the water filter	184
14	Troubleshooting	185
14.1	Overview: Troubleshooting	185
14.2	Precautions when troubleshooting	185
14.3	Solving problems based on symptoms.....	186
14.3.1	Symptom: The unit is NOT heating or cooling as expected.....	186
14.3.2	Symptom: Hot water does NOT reach the desired temperature.....	186
14.3.3	Symptom: The compressor does NOT start (space heating or domestic water heating)	187
14.3.4	Symptom: The system is making gurgling noises after commissioning	187
14.3.5	Symptom: The pump is making noise (cavitation).....	188
14.3.6	Symptom: The pressure relief valve opens.....	188
14.3.7	Symptom: The water pressure relief valve leaks	189
14.3.8	Symptom: The space is NOT sufficiently heated at low outdoor temperatures.....	189
14.3.9	Symptom: The pressure at the tapping point is temporarily unusually high.....	190
14.3.10	Symptom: Decoration panels are pushed away due to a swollen tank	190
14.3.11	Symptom: Tank disinfection function is NOT completed correctly (AH-error)	190
14.4	Solving problems based on error codes	191
14.4.1	To display the help text in case of a malfunction	191
14.4.2	Error codes: Overview	192
15	Disposal	198
15.1	To recover refrigerant.....	198
15.1.1	To open the stop valves	199
15.1.2	To manually open the electronic expansion valves	199
15.1.3	Recovery mode.....	200
16	Technical data	202

16.1	Service space: Outdoor unit	202
16.2	Piping diagram: Outdoor unit	203
16.3	Piping diagram: Indoor unit	204
16.4	Wiring diagram: Outdoor unit	205
16.5	Wiring diagram: Indoor unit	208
16.6	ESP curve: Indoor unit	214
17	Glossary	215
18	Field settings table	216

1 About this document

Target audience

Authorised installers

Documentation set

This document is part of a documentation set. The complete set consists of:

- **General safety precautions:**
 - Safety instructions that you must read before installing
 - Format: Paper (in the box of the indoor unit)
- **Operation manual:**
 - Quick guide for basic usage
 - Format: Paper (in the box of the indoor unit)
- **User reference guide:**
 - Detailed step-by-step instructions and background information for basic and advanced usage
 - Format: Digital files on <http://www.daikineurope.com/support-and-manuals/product-information/>
- **Installation manual – Outdoor unit:**
 - Installation instructions
 - Format: Paper (in the box of the outdoor unit)
- **Installation manual – Indoor unit:**
 - Installation instructions
 - Format: Paper (in the box of the indoor unit)
- **Installer reference guide:**
 - Preparation of the installation, good practices, reference data, ...
 - Format: Digital files on <http://www.daikineurope.com/support-and-manuals/product-information/>
- **Addendum book for optional equipment:**
 - Additional info about how to install optional equipment
 - Format: Paper (in the box of the indoor unit) + Digital files on <http://www.daikineurope.com/support-and-manuals/product-information/>

Latest revisions of the supplied documentation may be available on the regional Daikin website or via your dealer.

The original documentation is written in English. All other languages are translations.

Technical engineering data

- A **subset** of the latest technical data is available on the regional Daikin website (publicly accessible).
- The **full set** of latest technical data is available on the Daikin Business Portal (authentication required).

Online tools

In addition to the documentation set, some online tools are available for installers:

- **Heating Solutions Navigator**

- Digital toolbox that offers a variety of tools to facilitate the installation and configuration of heating systems.
- To access Heating Solutions Navigator, registration to the Stand By Me platform is required. For more information, see <https://professional.standbyme.daikin.eu>.

- **Daikin e-Care**

- Mobile app for installers and service technicians that allows you to register, configure and troubleshoot heating systems.
- The mobile app can be downloaded for iOS and Android devices using the QR codes below. Registration to the Stand By Me platform is required to access the app.

App Store



Google Play



1.1 Meaning of warnings and symbols

**DANGER**

Indicates a situation that results in death or serious injury.

**DANGER: RISK OF ELECTROCUTION**

Indicates a situation that could result in electrocution.

**DANGER: RISK OF BURNING/SCALDING**

Indicates a situation that could result in burning/scalding because of extreme hot or cold temperatures.

**DANGER: RISK OF EXPLOSION**

Indicates a situation that could result in explosion.

**WARNING**

Indicates a situation that could result in death or serious injury.

**WARNING: FLAMMABLE MATERIAL****CAUTION**

Indicates a situation that could result in minor or moderate injury.

**NOTICE**

Indicates a situation that could result in equipment or property damage.



INFORMATION

Indicates useful tips or additional information.

Symbols used on the unit:

Symbol	Explanation
	Before installation, read the installation and operation manual, and the wiring instruction sheet.
	Before performing maintenance and service tasks, read the service manual.
	For more information, see the installer and user reference guide.
	The unit contains rotating parts. Be careful when servicing or inspecting the unit.

Symbols used in the documentation:

Symbol	Explanation
	Indicates a figure title or a reference to it. Example: "▲ 1-3 Figure title" means "Figure 3 in chapter 1".
	Indicates a table title or a reference to it. Example: "■ 1-3 Table title" means "Table 3 in chapter 1".

1.2 Installer reference guide at a glance

Chapter	Description
General safety precautions	Safety instructions that you must read before installing
About the documentation	What documentation exists for the installer
About the box	How to unpack the units and remove their accessories
About the units and options	<ul style="list-style-type: none"> ▪ How to identify the units ▪ Possible combinations of units and options
Application guidelines	Various installation setups of the system
Preparation	What to do and know before going on-site
Installation	What to do and know to install the system
Configuration	What to do and know to configure the system after it is installed
Commissioning	What to do and know to commission the system after it is configured
Hand-over to the user	What to give and explain to the user
Maintenance and service	How to maintain and service the units
Troubleshooting	What to do in case of problems
Disposal	How to dispose of the system

Chapter	Description
Technical data	Specifications of the system
Glossary	Definition of terms
Field settings table	Table to be filled in by the installer, and kept for future reference Note: There is also an installer settings table in the user reference guide. This table has to be filled in by the installer and handed over to the user.

2 General safety precautions

In this chapter

2.1	For the installer.....	10
2.1.1	General.....	10
2.1.2	Installation site.....	11
2.1.3	Refrigerant — in case of R410A or R32.....	11
2.1.4	Water.....	13
2.1.5	Electrical.....	13

2.1 For the installer

2.1.1 General

If you are NOT sure how to install or operate the unit, contact your dealer.



DANGER: RISK OF BURNING/SCALDING

- Do NOT touch the refrigerant piping, water piping or internal parts during and immediately after operation. It could be too hot or too cold. Give it time to return to normal temperature. If you MUST touch it, wear protective gloves.
- Do NOT touch any accidental leaking refrigerant.



WARNING

Improper installation or attachment of equipment or accessories could result in electrical shock, short-circuit, leaks, fire or other damage to the equipment. ONLY use accessories, optional equipment and spare parts made or approved by Daikin.



WARNING

Make sure installation, testing and applied materials comply with applicable legislation (on top of the instructions described in the Daikin documentation).



CAUTION

Wear adequate personal protective equipment (protective gloves, safety glasses,...) when installing, maintaining or servicing the system.



WARNING

Tear apart and throw away plastic packaging bags so that nobody, especially children, can play with them. Possible risk: suffocation.



WARNING

Provide adequate measures to prevent that the unit can be used as a shelter by small animals. Small animals that make contact with electrical parts can cause malfunctions, smoke or fire.



CAUTION

Do NOT touch the air inlet or aluminium fins of the unit.

**CAUTION**

- Do NOT place any objects or equipment on top of the unit.
- Do NOT sit, climb or stand on the unit.

In accordance with the applicable legislation, it might be necessary to provide a logbook with the product containing at least: information on maintenance, repair work, results of tests, stand-by periods,...

Also, at least, following information **MUST** be provided at an accessible place at the product:

- Instructions for shutting down the system in case of an emergency
- Name and address of fire department, police and hospital
- Name, address and day and night telephone numbers for obtaining service

In Europe, EN378 provides the necessary guidance for this logbook.

2.1.2 Installation site

- Provide sufficient space around the unit for servicing and air circulation.
- Make sure the installation site withstands the weight and vibration of the unit.
- Make sure the area is well ventilated. Do NOT block any ventilation openings.
- Make sure the unit is level.

Do NOT install the unit in the following places:

- In potentially explosive atmospheres.
- In places where there is machinery that emits electromagnetic waves. Electromagnetic waves may disturb the control system, and cause malfunction of the equipment.
- In places where there is a risk of fire due to the leakage of flammable gases (example: thinner or gasoline), carbon fibre, ignitable dust.
- In places where corrosive gas (example: sulphurous acid gas) is produced. Corrosion of copper pipes or soldered parts may cause the refrigerant to leak.

2.1.3 Refrigerant — in case of R410A or R32

If applicable. See the installation manual or installer reference guide of your application for more information.

**NOTICE**

Make sure refrigerant piping installation complies with applicable legislation. In Europe, EN378 is the applicable standard.

**NOTICE**

Make sure the field piping and connections are NOT subjected to stress.

**WARNING**

During tests, NEVER pressurise the product with a pressure higher than the maximum allowable pressure (as indicated on the nameplate of the unit).



WARNING

Take sufficient precautions in case of refrigerant leakage. If refrigerant gas leaks, ventilate the area immediately. Possible risks:

- Excessive refrigerant concentrations in a closed room can lead to oxygen deficiency.
- Toxic gas might be produced if refrigerant gas comes into contact with fire.



DANGER: RISK OF EXPLOSION

Pump down – Refrigerant leakage. If you want to pump down the system, and there is a leak in the refrigerant circuit:

- Do NOT use the unit's automatic pump down function, with which you can collect all refrigerant from the system into the outdoor unit. **Possible consequence:** Self-combustion and explosion of the compressor because of air going into the operating compressor.
- Use a separate recovery system so that the unit's compressor does NOT have to operate.



WARNING

ALWAYS recover the refrigerant. Do NOT release them directly into the environment. Use a vacuum pump to evacuate the installation.



NOTICE

After all the piping has been connected, make sure there is no gas leak. Use nitrogen to perform a gas leak detection.



NOTICE

- To avoid compressor breakdown, do NOT charge more than the specified amount of refrigerant.
- When the refrigerant system is to be opened, refrigerant MUST be treated according to the applicable legislation.





WARNING

Make sure there is no oxygen in the system. Refrigerant may ONLY be charged after performing the leak test and the vacuum drying.

Possible consequence: Self-combustion and explosion of the compressor because of oxygen going into the operating compressor.

- In case recharge is required, see the nameplate of the unit. It states the type of refrigerant and necessary amount.
- The unit is factory charged with refrigerant and depending on pipe sizes and pipe lengths some systems require additional charging of refrigerant.
- ONLY use tools exclusively for the refrigerant type used in the system, this to ensure pressure resistance and prevent foreign materials from entering into the system.
- Charge the liquid refrigerant as follows:

If	Then
A siphon tube is present (i.e., the cylinder is marked with "Liquid filling siphon attached")	Charge with the cylinder upright. 
A siphon tube is NOT present	Charge with the cylinder upside down. 

- Open refrigerant cylinders slowly.
- Charge the refrigerant in liquid form. Adding it in gas form may prevent normal operation.

 **CAUTION**

When the refrigerant charging procedure is done or when pausing, close the valve of the refrigerant tank immediately. If the valve is NOT closed immediately, remaining pressure might charge additional refrigerant. **Possible consequence:** Incorrect refrigerant amount.

2.1.4 Water

If applicable. See the installation manual or installer reference guide of your application for more information.

 **NOTICE**

Make sure water quality complies with EU directive 2020/2184.

2.1.5 Electrical

 **DANGER: RISK OF ELECTROCUTION**

- Turn OFF all power supply before removing the switch box cover, connecting electrical wiring or touching electrical parts.
- Disconnect the power supply for more than 10 minutes, and measure the voltage at the terminals of main circuit capacitors or electrical components before servicing. The voltage MUST be less than 50 V DC before you can touch electrical components. For the location of the terminals, see the wiring diagram.
- Do NOT touch electrical components with wet hands.
- Do NOT leave the unit unattended when the service cover is removed.

 **WARNING**

If NOT factory installed, a main switch or other means for disconnection, having a contact separation in all poles providing full disconnection under overvoltage category III condition, MUST be installed in the fixed wiring.



WARNING

- ONLY use copper wires.
- Make sure the field wiring complies with the applicable legislation.
- All field wiring MUST be performed in accordance with the wiring diagram supplied with the product.
- NEVER squeeze bundled cables and make sure they do NOT come in contact with the piping and sharp edges. Make sure no external pressure is applied to the terminal connections.
- Make sure to install earth wiring. Do NOT earth the unit to a utility pipe, surge absorber, or telephone earth. Incomplete earth may cause electrical shock.
- Make sure to use a dedicated power circuit. NEVER use a power supply shared by another appliance.
- Make sure to install the required fuses or circuit breakers.
- Make sure to install an earth leakage protector. Failure to do so may cause electrical shock or fire.
- When installing the earth leakage protector, make sure it is compatible with the inverter (resistant to high frequency electric noise) to avoid unnecessary opening of the earth leakage protector.



CAUTION

- When connecting the power supply: connect the earth cable first, before making the current-carrying connections.
- When disconnecting the power supply: disconnect the current-carrying cables first, before separating the earth connection.
- The length of the conductors between the power supply stress relief and the terminal block itself MUST be as such that the current-carrying wires are tautened before the earth wire is in case the power supply is pulled loose from the stress relief.



NOTICE

Precautions when laying power wiring:



- Do NOT connect wiring of different thicknesses to the power terminal block (slack in the power wiring may cause abnormal heat).
- When connecting wiring which is the same thickness, do as shown in the figure above.
- For wiring, use the designated power wire and connect firmly, then secure to prevent outside pressure being exerted on the terminal board.
- Use an appropriate screwdriver for tightening the terminal screws. A screwdriver with a small head will damage the head and make proper tightening impossible.
- Over-tightening the terminal screws may break them.

Install power cables at least 1 meter away from televisions or radios to prevent interference. Depending on the radio waves, a distance of 1 meter may NOT be sufficient.



WARNING

- After finishing the electrical work, confirm that each electrical component and terminal inside the electrical components box is connected securely.
- Make sure all covers are closed before starting up the unit.



NOTICE

ONLY applicable if the power supply is three-phase, and the compressor has an ON/OFF starting method.

If there exists the possibility of reversed phase after a momentary black out and the power goes ON and OFF while the product is operating, attach a reversed phase protection circuit locally. Running the product in reversed phase can break the compressor and other parts.

3 Specific installer safety instructions

Always observe the following safety instructions and regulations.

Handling the unit (see "4.2.2 To handle the outdoor unit" [▶ 22])



CAUTION

To avoid injury, do NOT touch the air inlet or aluminium fins of the unit.

Application guidelines (see "6 Application guidelines" [▶ 30])



CAUTION

If there is more than one leaving water zone, ALWAYS install a mixing valve station in the main zone to decrease (in heating)/increase (in cooling) the leaving water temperature when the additional zone has demand.

Installation site (see "7.1 Preparing the installation site" [▶ 57])



WARNING

Follow the service space dimensions in this manual for correct installation of the unit. See "16.1 Service space: Outdoor unit" [▶ 202].

Special requirements for R32 (see "7.1.1 Installation site requirements of the outdoor unit" [▶ 57])



WARNING

- Do NOT pierce or burn refrigerant cycle parts.
- Do NOT use means to accelerate the defrosting process or to clean the equipment, other than those recommended by the manufacturer.
- Be aware that R32 refrigerant does NOT contain an odour.



WARNING

The appliance shall be stored in a room without continuously operating ignition sources (example: open flames, an operating gas appliance or an operating electric heater).



WARNING

Make sure installation, servicing, maintenance and repair comply with instructions from Daikin and with applicable legislation and are executed ONLY by authorised persons.

Mounting the outdoor unit (see "7.3 Mounting the outdoor unit" [▶ 65])



WARNING

Fixing method of the outdoor unit MUST be in accordance with the instructions from this manual. See "7.3 Mounting the outdoor unit" [▶ 65].

Mounting the indoor unit (see "7.4 Mounting the indoor unit" [▶ 68])



WARNING

Fixing method of the indoor unit MUST be in accordance with the instructions from this manual. See "7.4 Mounting the indoor unit" [▶ 68].

Opening and closing the units (see "7.2 Opening and closing the units" [▶ 61])**DANGER: RISK OF ELECTROCUTION**

Do NOT leave the unit unattended when the service cover is removed.

**DANGER: RISK OF ELECTROCUTION****DANGER: RISK OF BURNING/SCALDING****Piping installation (see "8 Piping installation" [▶ 70])****WARNING**

Field piping method MUST be in accordance with the instructions from this manual. See "8 Piping installation" [▶ 70].

**WARNING**

Install the tundish away from any electrical device. **Possible consequence:** Electrical shock or fire.

In case of freeze protection by glycol:

**WARNING**

Due to the presence of glycol, corrosion of the system is possible. Uninhibited glycol will turn acidic under the influence of oxygen. This process is accelerated by the presence of copper and high temperatures. The acidic uninhibited glycol attacks metal surfaces and forms galvanic corrosion cells that cause severe damage to the system. Therefore it is important that:

- the water treatment is correctly executed by a qualified water specialist,
- a glycol with corrosion inhibitors is selected to counteract acids formed by the oxidation of glycols,
- no automotive glycol is used because their corrosion inhibitors have a limited lifetime and contain silicates which can foul or plug the system,
- galvanized pipes are NOT used in glycol systems since the presence may lead to the precipitation of certain components in the glycol's corrosion inhibitor.

**WARNING**

Ethylene glycol is toxic.

Electrical installation (see "9 Electrical installation" [▶ 84])**DANGER: RISK OF ELECTROCUTION**



WARNING

Electrical wiring connection method **MUST** be in accordance with the instructions from:

- This manual. See "[9 Electrical installation](#)" [▶ 84].
- The wiring diagram, which is delivered with the unit, located at the inside of the service cover. For a translation of its legend, see "[16.4 Wiring diagram: Outdoor unit](#)" [▶ 205].



WARNING

ALWAYS use multicore cable for power supply cables.



WARNING

- All wiring **MUST** be performed by an authorised electrician and **MUST** comply with the applicable legislation.
- Make electrical connections to the fixed wiring.
- All components procured on-site and all electrical construction **MUST** comply with the applicable legislation.



WARNING

- If the power supply has a missing or wrong N-phase, equipment might break down.
- Establish proper earthing. Do **NOT** earth the unit to a utility pipe, surge absorber, or telephone earth. Incomplete earthing may cause electrical shock.
- Install the required fuses or circuit breakers.
- Secure the electrical wiring with cable ties so that the cables do **NOT** come in contact with sharp edges or piping, particularly on the high-pressure side.
- Do **NOT** use taped wires, stranded conductor wires, extension cords, or connections from a star system. They can cause overheating, electrical shock or fire.
- Do **NOT** install a phase advancing capacitor, because this unit is equipped with an inverter. A phase advancing capacitor will reduce performance and may cause accidents.



WARNING

The backup heater **MUST** have a dedicated power supply and **MUST** be protected by the safety devices required by the applicable legislation.



WARNING

If the supply cord is damaged, it **MUST** be replaced by the manufacturer, its service agent or similarly qualified persons in order to avoid a hazard.



CAUTION

Do **NOT** push or place redundant cable length in the unit.



CAUTION

To guarantee the unit is completely earthed, **ALWAYS** connect the backup heater power supply and the earth cable.

**INFORMATION**

Details of type and rating of fuses, or rating of circuit breakers are described in "9 Electrical installation" [▶ 84].

Configuration (see "10 Configuration" [▶ 99])**WARNING**

Be aware that the domestic hot water temperature at the hot water tap will be equal to the value selected in field setting [2-03] after a disinfection operation.

When the high domestic hot water temperature can be a potential risk for human injuries, a mixing valve (field supply) shall be installed at the hot water outlet connection of the domestic hot water tank. This mixing valve shall secure that the hot water temperature at the hot water tap never rise above a set maximum value. This maximum allowable hot water temperature shall be selected according to the applicable legislation.

**CAUTION**

The disinfection function settings **MUST** be configured by the installer according to the applicable legislation.

**CAUTION**

Make sure that the disinfection function start time [5.7.3] with defined duration [5.7.5] is **NOT** interrupted by possible domestic hot water demand.

Commissioning (see "11 Commissioning" [▶ 169])**WARNING**

Commissioning method **MUST** be in accordance with the instructions from this manual. See "11 Commissioning" [▶ 169].

Maintenance and service (see Maintenance and service)**WARNING**

If the internal wiring is damaged, it has to be replaced by the manufacturer, its service agent or similarly qualified persons.

**CAUTION**

Water coming out of the valve may be very hot.

**NOTICE**

Although the water circuit is drained, some water may be spilled when removing the magnetic filter/dirt separator from the filter housing. **ALWAYS** clean up spilled water.

**NOTICE**

To protect the piping connected to the magnetic filter/dirt separator from damage it is recommended to perform this procedure with the magnetic filter/dirt separator removed from the unit.



NOTICE

Opening the magnetic filter/dirt separator is ONLY required in case of severe issues. Preferably this action is never to be done during the complete lifetime of the magnetic filter/dirt separator.



NOTICE

Check the condition of the O-rings and replace if needed. Apply water to the O-rings before installation.



CAUTION

Make sure to open the valve (if equipped) towards the expansion vessel, otherwise the overpressure will be generated.

Troubleshooting (see "14 Troubleshooting" [▶ 185])



DANGER: RISK OF BURNING/SCALDING



WARNING

- When carrying out an inspection on the switch box of the unit, ALWAYS make sure that the unit is disconnected from the mains. Turn off the respective circuit breaker.
- When a safety device was activated, stop the unit and find out why the safety device was activated before resetting it. NEVER shunt safety devices or change their values to a value other than the factory default setting. If you are unable to find the cause of the problem, call your dealer.





WARNING

Prevent hazards due to inadvertent resetting of the thermal cut-out: power to this appliance MUST NOT be supplied through an external switching device, such as a timer, or connected to a circuit that is regularly turned ON and OFF by the utility.



WARNING

Air purging heat emitters or collectors. Before you purge air from heat emitters or collectors, check if  or  is displayed on the home screen of the user interface.

- If not, you can purge air immediately.
- If yes, make sure that the room where you want to purge air is sufficiently ventilated. **Reason:** Refrigerant might leak into the water circuit, and subsequently into the room when you purge air from the heat emitters or collectors.

4 About the box

4.1 Overview: About the box

This chapter describes what you have to do after the boxes with the outdoor and indoor unit are delivered on-site.

Keep the following in mind:

- At delivery, the unit **MUST** be checked for damage. Any damage **MUST** be reported immediately to the claims agent of the carrier.
- Bring the packed unit as close as possible to its final installation position to prevent damage during transport.
- Prepare the path along which you want to bring the unit inside in advance.

4.2 Outdoor unit

4.2.1 To unpack the outdoor unit

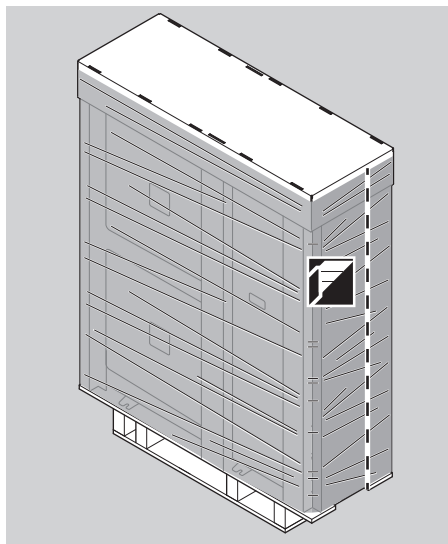

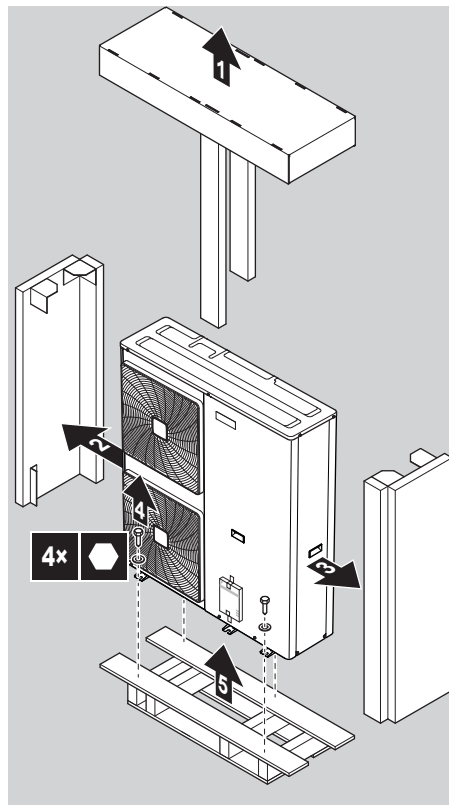

4.2.2 To handle the outdoor unit

 **CAUTION**
To avoid injury, do NOT touch the air inlet or aluminium fins of the unit.

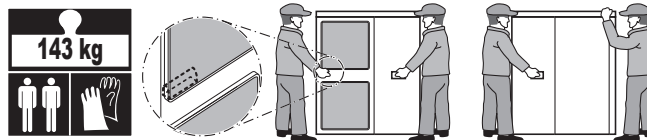

4.2.3 To remove the accessories from the outdoor unit

- 1 Open the outdoor unit.
- 2 Remove the accessories.

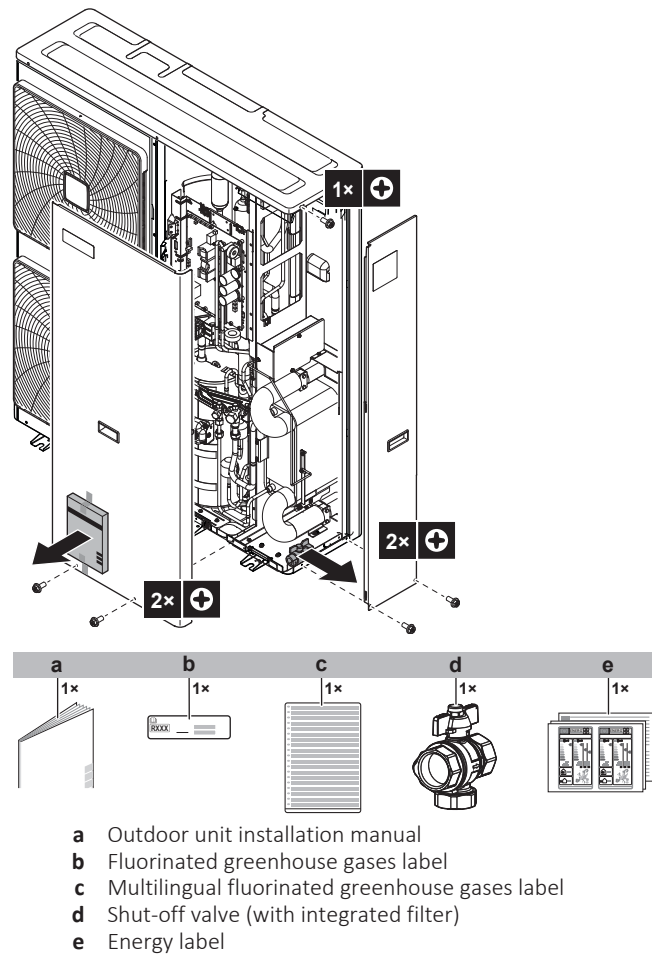

4.2.4 To remove the transportation stay



NOTICE

If the unit is operated with the transportation stay attached, abnormal vibration or noise may be generated.

The compressor transportation stay must be removed. It is installed under the compressor leg in order to protect the unit during transport. Proceed as shown in the figure and procedure below.

- 1 Remove the nut (a) of the compressor mounting bolt.
- 2 Remove and discard the transportation stay (b).
- 3 Re-install the nut (a) of the compressor mounting bolt and tighten to 10.1 N•m of torque.

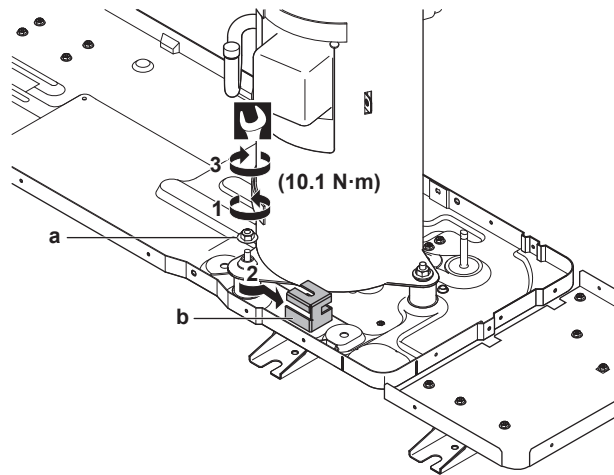

4.3 Indoor unit

4.3.1 To unpack the indoor unit

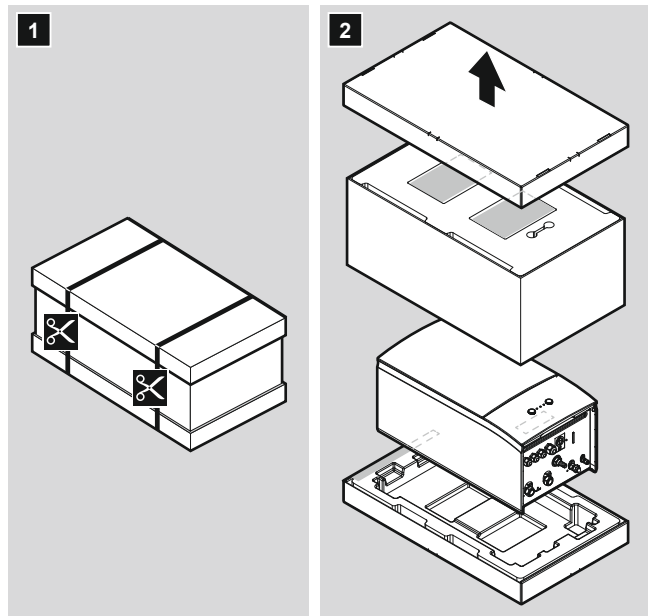

4.3.2 To remove the accessories from the indoor unit

Some accessories are located inside the unit. To open the unit, see ["7.2.5 To open the indoor unit" \[▶ 63\]](#).

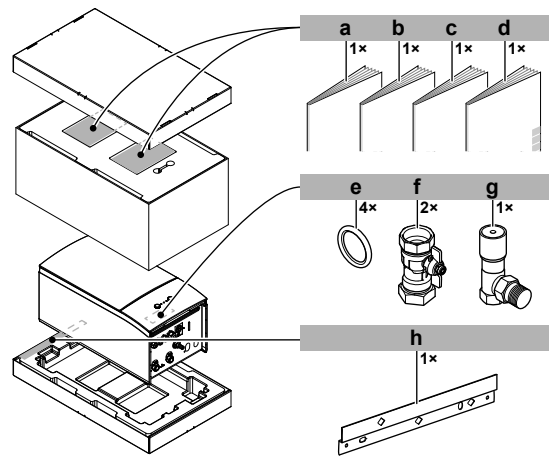

- a** General safety precautions
- b** Addendum book for optional equipment
- c** Indoor unit installation manual
- d** Operation manual
- e** Sealing ring for shut-off valve
- f** Shut-off valve
- g** Overpressure bypass valve
- h** Wall bracket

5 About the units and options

5.1 Overview: About the units and options

This chapter contains information about:

- Identifying the outdoor unit
- Identifying the indoor unit
- Combining the outdoor unit with options
- Combining the indoor unit with options

5.2 Identification

5.2.1 Identification label: Outdoor unit

Location

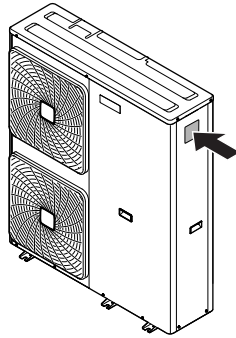

Model identification

Example: EP G A 11 DA V3

Code	Explanation
EP	European hydro-split outdoor pair heat pump
G	Medium water temperature – ambient zone: -10~-20°C
A	Refrigerant R32
11	Capacity class
DA	Model series
V3	Power supply

5.2.2 Identification label: Indoor unit

Location

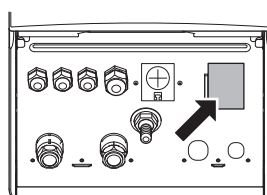

Model identification**Example:** E AB H 16 DF 6V

Code	Description
E	European model
AB	Wall-mounted hydro-split unit with separated tank
H	H=Heating only X=Heating/cooling
16	Capacity class
DF	Model series
6V	Backup heater model

5.3 Combining units and options

**INFORMATION**

Certain options might NOT be available in your country.

5.3.1 Possible options for the outdoor unit

Bottom plate heater (EKBP140L7)

- Prevents freeze-up of the bottom plate.
- Recommended in areas with low ambient temperature and high humidity.

For installation instructions, see the installation manual of the bottom plate heater.

5.3.2 Possible options for the indoor unit

User interface used as room thermostat (BRC1HHDA)

- The user interface used as room thermostat can only be used in combination with the user interface connected to the indoor unit.
- The user interface used as room thermostat needs to be installed in the room that you want to control.

For installation instructions, see the installation and operation manual of the user interface used as room thermostat.

Room thermostat (EKRTWA, EKTR1)

You can connect an optional room thermostat to the indoor unit. This thermostat can either be wired (EKRTWA) or wireless (EKTR1).

For installation instructions, see the installation manual of the room thermostat and addendum book for optional equipment.

Remote sensor for wireless thermostat (EKRTETS)

You can use the remote indoor temperature sensor (EKRTETS) only in combination with the wireless thermostat (EKTR1).

For installation instructions, see the installation manual of the room thermostat and the addendum book for optional equipment.

Digital I/O PCB (EKRP1HBAA)

The digital I/O PCB is required to provide following signals:

- Alarm output
- Space heating/cooling ON/OFF output
- Changeover to external heat source

For installation instructions, see the installation manual of the digital I/O PCB and addendum book for optional equipment.

Demand PCB (EKRP1AHTA)

To enable the power saving consumption control by digital inputs you MUST install the demand PCB.

For installation instructions, see the installation manual of the demand PCB and addendum book for optional equipment.

Remote indoor sensor (KRCS01-1)

By default the internal user interface sensor will be used as room temperature sensor.

As an option the remote indoor sensor can be installed to measure the room temperature on another location.

For installation instructions, see the installation manual of the remote indoor sensor and addendum book for optional equipment.



INFORMATION

- The remote indoor sensor can only be used in case the user interface is configured with room thermostat functionality.
- You can only connect either the remote indoor sensor or the remote outdoor sensor.

Remote outdoor sensor (EKRSOA1)

By default the sensor inside the outdoor unit will be used to measure the outdoor temperature.

As an option the remote outdoor sensor can be installed to measure the outdoor temperature on another location (e.g. to avoid direct sunlight) to have an improved system behaviour.

For installation instructions, see the installation manual of the remote outdoor sensor and the addendum book for optional equipment.



INFORMATION

You can only connect either the remote indoor sensor or the remote outdoor sensor.

PC cable (EKPCAB4)

The PC cable makes a connection between the switch box of the indoor unit and a PC. It gives the possibility to update the software of the indoor unit.

For installation instructions, see the installation manual of the PC cable.

Heat pump convector (FWXV)

For providing space heating/cooling, it is possible to use heat pump convectors (FWXV).

For installation instructions, see the installation manual of the heat pump convectors, and the addendum book for optional equipment.

LAN adapter for smartphone control + Smart Grid applications (BRP069A61)

You can install this LAN adapter to:

- Control the system via a smartphone app.
- Use the system in various Smart Grid applications.

For installation instructions, see the installation manual of the LAN adapter.

LAN adapter for smartphone control (BRP069A62)

You can install this LAN adapter to control the system via a smartphone app.

For installation instructions, see the installation manual of the LAN adapter.

Universal centralised controller (EKCC8-W)

Controller for cascade control.

Bizone kit (BZKA7V3)

You can install an optional bizon kit.

For installation instructions, see the installation manual of the bizon kit.

Connection kit for third-party tank (EKHY3PART)

Required when connecting a third-party tank to the system.

Contains a thermistor, a 3-way valve, and a contactor K3M – terminal X7M assembly.

For installation instructions, see the installation manual of the connection kit.

Connection kit for third-party tank with built-in thermostat (EKHY3PART2)

Kit for the connection of a third-party tank with built-in thermostat to the system. The kit converts a thermostat demand from the tank to a domestic hot water request for the indoor unit.

Smart grid relay kit (EKRELSG)

The installation of the optional Smart grid relay kit is required in case of high voltage Smart grid contacts (EKRELSG).

For installation instructions, see the installation manual of the Smart grid relay kit.

5.3.3 Possible combinations of indoor unit and outdoor unit

Indoor unit	Outdoor unit		
	EPGA11	EPGA14	EPGA16
EABH/X	○	○	○

5.3.4 Possible combinations of indoor unit and domestic hot water tank

Indoor unit	Domestic hot water tank		
	EKHWS	EKHWSU	EKHWP
EABH/X	○	○	○

6 Application guidelines



INFORMATION

Cooling is only applicable in case of:

- Reversible models
- Heating only models + conversion kit (EKHBCONV*)



INFORMATION

Cooling is only applicable in case of reversible models.

6.1 Overview: Application guidelines

The purpose of the application guidelines is to give a glance of the possibilities of the heat pump system.



NOTICE

- The illustrations in the application guidelines are meant for reference only, and are NOT to be used as detailed hydraulic diagrams. The detailed hydraulic dimensioning and balancing are NOT shown, and are the responsibility of the installer.
- For more information about the configuration settings to optimize heat pump operation, see "[10 Configuration](#)" [▶ 99].

This chapter contains application guidelines for:

- Setting up the space heating/cooling system
- Setting up an auxiliary heat source for space heating
- Setting up the domestic hot water tank
- Setting up the energy metering
- Setting up the power consumption control
- Setting up an external temperature sensor

6.2 Setting up the space heating/cooling system

The heat pump system supplies leaving water to heat emitters in one or more rooms.

Because the system offers a wide flexibility to control the temperature in each room, you need to answer the following questions first:

- How many rooms are heated or cooled by the heat pump system?
- Which heat emitter types are used in each room and what is their design leaving water temperature?

Once the space heating/cooling requirements are clear, we recommend to follow the setup guidelines below.

**NOTICE**

If an external room thermostat is used, the external room thermostat will control the room frost protection. However, the room frost protection is only possible if [C.2] Space heating/cooling=On.

**INFORMATION**

In case an external room thermostat is used and room frost protection needs to be guaranteed in all conditions, then you have to set **Emergency** [9.5.1] to **Automatic**.

**NOTICE**

An overpressure bypass valve can be integrated in the system. Keep in mind that this valve might not be shown on the illustrations.

6.2.1 Single room

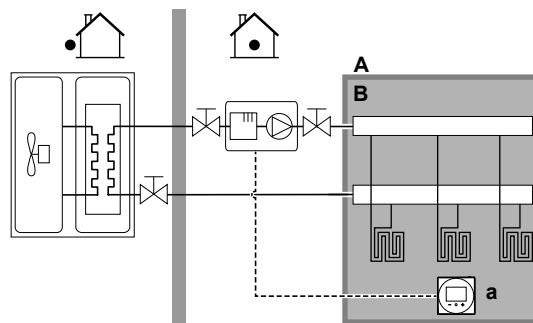
Underfloor heating or radiators – Wired room thermostat**Setup**

- A Main leaving water temperature zone
- B One single room
- a User interface used as room thermostat

- The underfloor heating or radiators are connected as follows:
 - Warm water → Indoor unit
 - Cold water → Outdoor unit
- The room temperature of the main room is controlled by the user interface used as a room thermostat (optional equipment BRC1H).

Configuration

Setting	Value
Unit temperature control: ▪ #: [2.9] ▪ Code: [C-07]	2 (Room thermostat): Unit operation is decided based on the ambient temperature of the user interface.
Number of water temperature zones: ▪ #: [4.4] ▪ Code: [7-02]	0 (Single zone): Main

Benefits

- **Highest comfort and efficiency.** The smart room thermostat functionality can decrease or increase the desired leaving water temperature based on the actual room temperature (modulation). This results in:
 - Stable room temperature matching the desired temperature (higher comfort)
 - Less ON/OFF cycles (more quiet, higher comfort and higher efficiency)
 - Lowest possible leaving water temperature (higher efficiency)
- **Easy.** You can easily set the desired room temperature via the user interface:
 - For your daily needs, you can use preset values and schedules.
 - To deviate from your daily needs, you can temporarily overrule the preset values and schedules, or use the holiday mode.

Underfloor heating or radiators – Wireless room thermostat

Setup

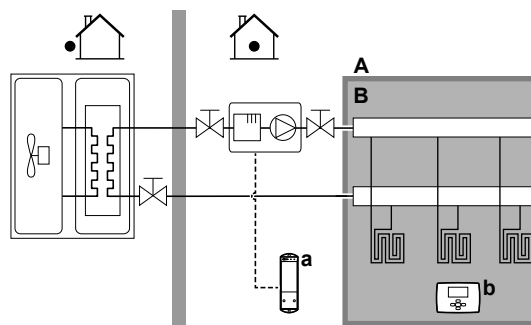

- A** Main leaving water temperature zone
- B** One single room
- a** Receiver for wireless external room thermostat
- b** Wireless external room thermostat

- The underfloor heating or radiators are connected as follows:
 - Warm water → Indoor unit
 - Cold water → Outdoor unit
- The room temperature is controlled by the wireless external room thermostat (optional equipment EKRTR1).

Configuration

Setting	Value
Unit temperature control: ▪ #: [2.9] ▪ Code: [C-07]	1 (External room thermostat): Unit operation is decided by the external thermostat.
Number of water temperature zones: ▪ #: [4.4] ▪ Code: [7-02]	0 (Single zone): Main
External room thermostat for the main zone: ▪ #: [2.A] ▪ Code: [C-05]	1 (1 contact): When the used external room thermostat or heat pump convector can only send a thermo ON/OFF condition. No separation between heating or cooling demand.

Benefits

- **Wireless.** The Daikin external room thermostat is available in a wireless version.
- **Efficiency.** Although the external room thermostat only sends ON/OFF signals, it is specifically designed for the heat pump system.
- **Comfort.** In case of underfloor heating, the wireless external room thermostat prevents condensation on the floor during cooling operation by measuring the room humidity.

Heat pump convectors

Setup

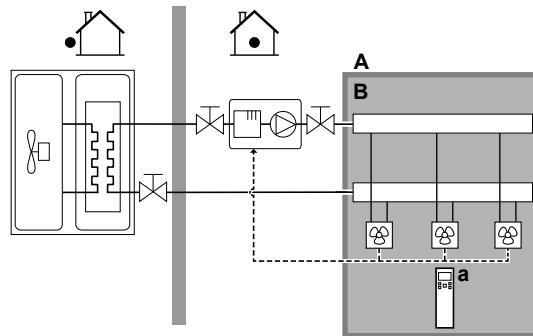

- A Main leaving water temperature zone
- B One single room
- a Remote controller of the heat pump convectors

- The heat pump convectors are connected as follows:
 - Warm water → Indoor unit
 - Cold water → Outdoor unit
- The desired room temperature is set via the remote controller of the heat pump convectors.
- The space heating/cooling demand signal is sent to one digital input on the indoor unit (X2M/35 and X2M/30).
- The space operation mode is sent to the heat pump convectors by one digital output on the indoor unit (X2M/4 and X2M/3).



INFORMATION

When using multiple heat pump convectors, make sure each one receives the infrared signal from the remote controller of the heat pump convectors.

Configuration

Setting	Value
Unit temperature control: ▪ #: [2.9] ▪ Code: [C-07]	1 (External room thermostat): Unit operation is decided by the external thermostat.
Number of water temperature zones: ▪ #: [4.4] ▪ Code: [7-02]	0 (Single zone): Main

Setting	Value
External room thermostat for the main zone: <ul style="list-style-type: none"> ▪ #: [2.A] ▪ Code: [C-05] 	1 (1 contact): When the used external room thermostat or heat pump convector can only send a thermo ON/OFF condition. No separation between heating or cooling demand.

Benefits

- **Cooling.** The heat pump convector offers, besides heating capacity, also excellent cooling capacity.
- **Efficiency.** Optimal energy efficiency because of the interlink function.
- **Stylish.**

Combination: Underfloor heating + Heat pump convectors

- Space heating is provided by:
 - The underfloor heating
 - The heat pump convectors
- Space cooling is provided by the heat pump convectors only. The underfloor heating is shut off by the shut-off valve.

Setup

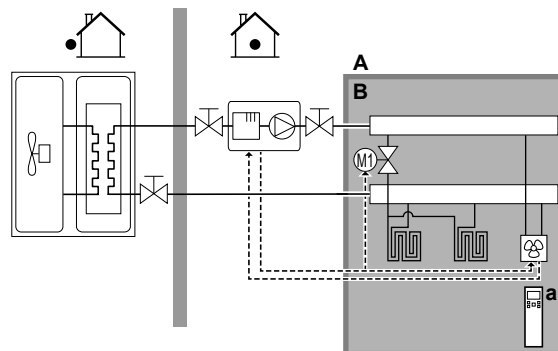

- A** Main leaving water temperature zone
- B** One single room
- a** Remote controller of the heat pump convectors

- The heat pump convectors are connected as follows:
 - Warm water → Indoor unit
 - Cold water → Outdoor unit
- A shut-off valve (field supply) is installed before the underfloor heating to prevent condensation on the floor during cooling operation.
- The desired room temperature is set via the remote controller of the heat pump convectors.
- The space heating/cooling demand signal is sent to one digital input on the indoor unit (X2M/35 and X2M/30).
- The space operation mode is sent by one digital output (X2M/4 and X2M/3) on the indoor unit to:
 - The heat pump convectors
 - The shut-off valve

Configuration

Setting	Value
Unit temperature control: <ul style="list-style-type: none"> ▪ #: [2.9] ▪ Code: [C-07] 	1 (External room thermostat): Unit operation is decided by the external thermostat.
Number of water temperature zones: <ul style="list-style-type: none"> ▪ #: [4.4] ▪ Code: [7-02] 	0 (Single zone): Main
External room thermostat for the main zone: <ul style="list-style-type: none"> ▪ #: [2.A] ▪ Code: [C-05] 	1 (1 contact): When the used external room thermostat or heat pump convector can only send a thermo ON/OFF condition. No separation between heating or cooling demand.

Benefits

- **Cooling.** Heat pump convectors provide, besides heating capacity, also excellent cooling capacity.
- **Efficiency.** Underfloor heating has the best performance with the heat pump system.
- **Comfort.** The combination of the two heat emitter types provides:
 - The excellent heating comfort of the underfloor heating
 - The excellent cooling comfort of the heat pump convectors

6.2.2 Multiple rooms – One LWT zone

If only one leaving water temperature zone is needed because the design leaving water temperature of all heat emitters is the same, you do NOT need a mixing valve station (cost effective).

Example: If the heat pump system is used to heat up one floor where all the rooms have the same heat emitters.

Underfloor heating or radiators – Thermostatic valves

If you are heating up rooms with underfloor heating or radiators, a very common way is to control the temperature of the main room by using a thermostat (this can either be the user interface or an external room thermostat), while the other rooms are controlled by so-called thermostatic valves, which open or close depending on the room temperature.

Setup

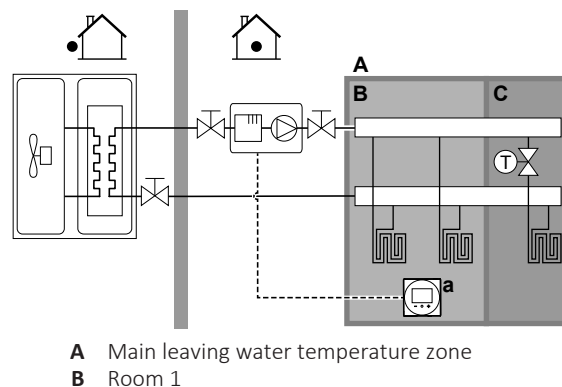

- C** Room 2
- a** User interface used as room thermostat

- The underfloor heating of the main room is connected as follows:
 - Warm water → Indoor unit
 - Cold water → Outdoor unit
- The room temperature of the main room is controlled by the user interface used as a room thermostat (optional equipment BRC1H).
- A thermostatic valve is installed before the underfloor heating in each of the other rooms.



INFORMATION

Mind situations where the main room can be heated by another heating source.
Example: Fireplaces.

Configuration

Setting	Value
Unit temperature control: ▪ #: [2.9] ▪ Code: [C-07]	2 (Room thermostat): Unit operation is decided based on the ambient temperature of the user interface.
Number of water temperature zones: ▪ #: [4.4] ▪ Code: [7-02]	0 (Single zone): Main

Benefits

- **Easy.** Same installation as for one room, but with thermostatic valves.

Underfloor heating or radiators – Multiple external room thermostats

Setup

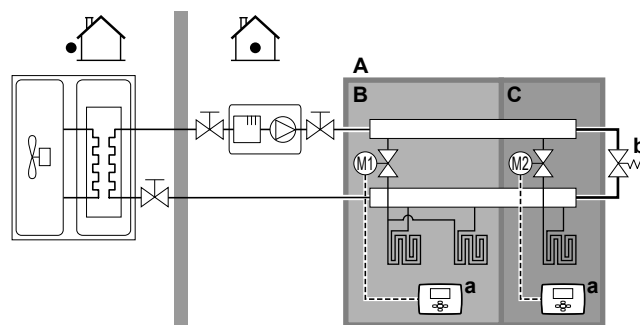

- A** Main leaving water temperature zone
- B** Room 1
- C** Room 2
- a** External room thermostat
- b** Bypass valve

- For each room, a shut-off valve (field supplied) is installed to avoid leaving water supply when there is no heating or cooling demand.
- A bypass valve must be installed to make water recirculation possible when all shut-off valves are closed. To guarantee reliable operation, provide a minimum water flow as described in table "To check the water volume and flow rate" in "8.1 Preparing water piping" [▶ 70].

- The user interface integrated in the indoor unit decides the space operation mode. Mind that the operation mode on each room thermostat must be set to match the indoor unit.
- The room thermostats are connected to the shut-off valves, but do NOT have to be connected to the indoor unit. The indoor unit will supply leaving water all the time, with the possibility to program a leaving water schedule.

Configuration

Setting	Value
Unit temperature control: ▪ #: [2.9] ▪ Code: [C-07]	0 (Leaving water): Unit operation is decided based on the leaving water temperature.
Number of water temperature zones: ▪ #: [4.4] ▪ Code: [7-02]	0 (Single zone): Main

Benefits

Compared with underfloor heating or radiators for one room:

- **Comfort.** You can set the desired room temperature, including schedules, for each room via the room thermostats.

Heat pump convectors – Multiple rooms

Setup

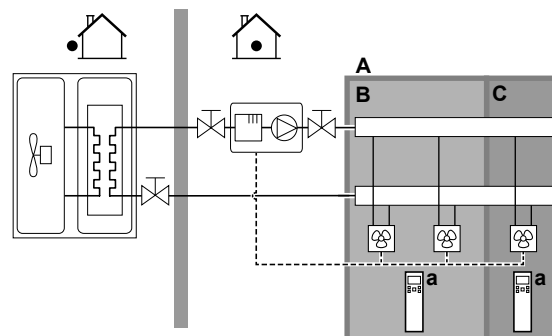

- A** Main leaving water temperature zone
- B** Room 1
- C** Room 2
- a** Remote controller of the heat pump convectors

- The desired room temperature is set via the remote controller of the heat pump convectors.
- The user interface integrated in the indoor unit decides the space operation mode.
- The heating or cooling demand signals of each heat pump convector are connected in parallel to the digital input on the indoor unit (X2M/35 and X2M/30). The indoor unit will only supply leaving water temperature when there is an actual demand.



INFORMATION

To increase comfort and performance, we recommend to install the valve kit option EKVKHPC on each heat pump convector.

Configuration

Setting	Value
Unit temperature control: ▪ #: [2.9] ▪ Code: [C-07]	1 (External room thermostat): Unit operation is decided by the external thermostat.
Number of water temperature zones: ▪ #: [4.4] ▪ Code: [7-02]	0 (Single zone): Main

Benefits

Compared with heat pump convectors for one room:

- **Comfort.** You can set the desired room temperature, including schedules, for each room via the remote controller of the heat pump convectors.

Combination: Underfloor heating + Heat pump convectors – Multiple rooms

Setup

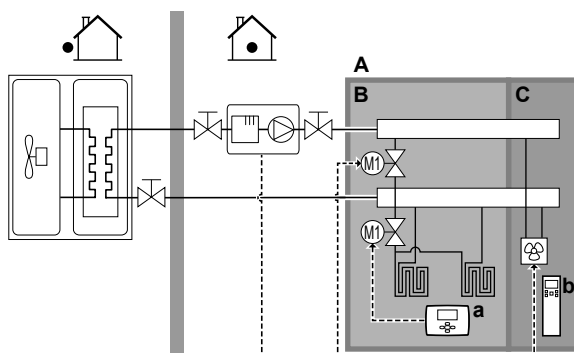

- A Main leaving water temperature zone
- B Room 1
- C Room 2
- a External room thermostat
- b Remote controller of the heat pump convectors

- For each room with heat pump convectors: The heat pump convectors are connected as follows:
 - Warm water → Indoor unit
 - Cold water → Outdoor unit
- For each room with underfloor heating: Two shut-off valves (field supply) are installed before the underfloor heating:
 - A shut-off valve to prevent hot water supply when the room has no heating demand
 - A shut-off valve to prevent condensation on the floor during cooling operation of the rooms with heat pump convectors.
- For each room with heat pump convectors: The desired room temperature is set via the remote controller of the heat pump convectors.
- For each room with underfloor heating: The desired room temperature is set via the external room thermostat (wired or wireless).
- The user interface integrated in the indoor unit decides the space operation mode. Mind that the operation mode on each external room thermostat and remote controller of the heat pump convectors must be set to match the indoor unit.

**INFORMATION**

To increase comfort and performance, we recommend to install the valve kit option EKVKHPC on each heat pump convector.

Configuration

Setting	Value
Unit temperature control: ▪ #: [2.9] ▪ Code: [C-07]	0 (Leaving water): Unit operation is decided based on the leaving water temperature.
Number of water temperature zones: ▪ #: [4.4] ▪ Code: [7-02]	0 (Single zone): Main

6.2.3 Multiple rooms – Two LWT zones

In this document:

- Main zone = Zone with the lowest design temperature in heating, and the highest design temperature in cooling
- Additional zone = Zone with the highest design temperature in heating, and the lowest design temperature in cooling

**CAUTION**

If there is more than one leaving water zone, ALWAYS install a mixing valve station in the main zone to decrease (in heating)/increase (in cooling) the leaving water temperature when the additional zone has demand.

Typical example:

Room (zone)	Heat emitters: Design temperature
Living room (main zone)	Underfloor heating: ▪ In heating: 35°C ▪ In cooling: 20°C (only refreshment, no real cooling allowed)
Bed rooms (additional zone)	Heat pump convectors: ▪ In heating: 45°C ▪ In cooling: 12°C

Setup

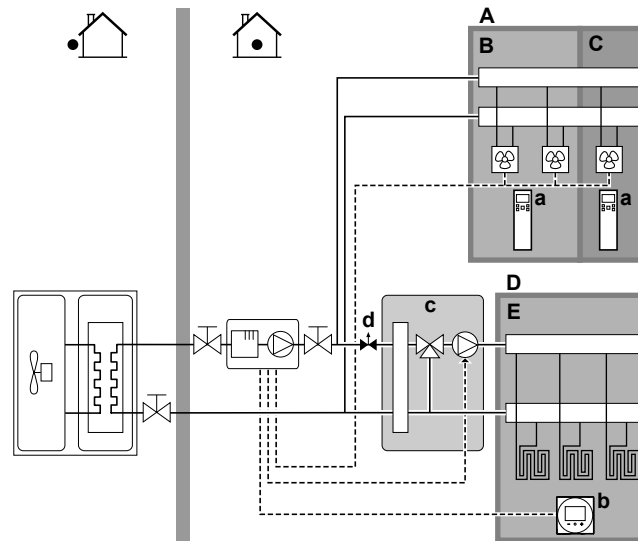

- A Additional leaving water temperature zone
- B Room 1
- C Room 2
- D Main leaving water temperature zone
- E Room 3
- a Remote controller of the heat pump convectors
- b User interface used as room thermostat
- c Mixing valve station
- d Pressure regulating valve

**INFORMATION**

A pressure regulating valve should be implemented before the mixing valve station. This is to guarantee the correct water flow balance between the main leaving water temperature zone and the additional leaving water temperature zone in relation to the required capacity of both water temperature zones.

- For the main zone:
 - A mixing valve station is installed before the underfloor heating.
 - The pump of the mixing valve station is controlled by the ON/OFF signal on the indoor unit (X2M/29 and X2M/21; normally closed shut-off valve output).
 - The room temperature is controlled by the user interface, which is used as room thermostat (optional equipment BRC1H).
- For the additional zone:
 - The heat pump convectors are directly connected to the indoor unit.
 - The desired room temperature is set via the remote controller of the heat pump convectors for each room.
 - The heating or cooling demand signals of each heat pump convector are connected in parallel to the digital input on the indoor unit (X2M/35 and X2M/30). The indoor unit will only supply the desired additional leaving water temperature when there is an actual demand.
- The user interface integrated in the indoor unit decides the space operation mode. Mind that the operation mode on each remote controller of the heat pump convectors must be set to match the indoor unit.

Configuration

Setting	Value
Unit temperature control: <ul style="list-style-type: none"> ▪ #: [2.9] ▪ Code: [C-07] 	2 (Room thermostat): Unit operation is decided based on the ambient temperature of the user interface. <p>Note:</p> <ul style="list-style-type: none"> ▪ Main room = user interface used as room thermostat functionality ▪ Other rooms = external room thermostat functionality
Number of water temperature zones: <ul style="list-style-type: none"> ▪ #: [4.4] ▪ Code: [7-02] 	1 (Dual zone): Main + additional
In case of heat pump convectors: External room thermostat for the additional zone: <ul style="list-style-type: none"> ▪ #: [3.A] ▪ Code: [C-06] 	1 (1 contact): When the used external room thermostat or heat pump convector can only send a thermo ON/OFF condition. No separation between heating or cooling demand.
Shut-off valve output	Set to follow the thermo demand of the main zone.
Shut-off valve	If the main zone must be shut off during cooling mode to prevent condensation on the floor, set it accordingly.
At the mixing valve station	Set the desired main leaving water temperature for heating and/or cooling.

Benefits

- **Comfort.**

- The smart room thermostat functionality can decrease or increase the desired leaving water temperature based on the actual room temperature (modulation).
- The combination of the two heat emitter systems provides the excellent heating comfort of the underfloor heating, and the excellent cooling comfort of the heat pump convectors.

- **Efficiency.**

- Depending on the demand, the indoor unit supplies different leaving water temperature matching the design temperature of the different heat emitters.
- Underfloor heating has the best performance with the heat pump system.

6.3 Setting up an auxiliary heat source for space heating



INFORMATION

Bivalent is only possible in case of 1 leaving water temperature zone with:

- room thermostat control, OR
- external room thermostat control.

- Space heating can be done by:
 - The indoor unit
 - An auxiliary boiler (field supply) connected to the system
- When there is a heating request, the indoor unit or the auxiliary boiler starts operating. Which of these units operates, depends on the outdoor temperature (status of the changeover to external heat source). When the permission is given to the auxiliary boiler, the space heating by the indoor unit is turned OFF.
- Bivalent operation is only possible if:
 - Space heating is turned ON, and
 - DHW tank operation is turned OFF
- Domestic hot water is always produced by the DHW tank connected to the indoor unit.



INFORMATION

- During heating operation of the heat pump, the heat pump operates to achieve the desired temperature set via the user interface. When weather-dependent operation is active, the water temperature is determined automatically depending on the outdoor temperature.
- During heating operation of the auxiliary boiler, the auxiliary boiler operates to achieve the desired water temperature set via the auxiliary boiler controller.

Setup

- Integrate the auxiliary boiler as follows:

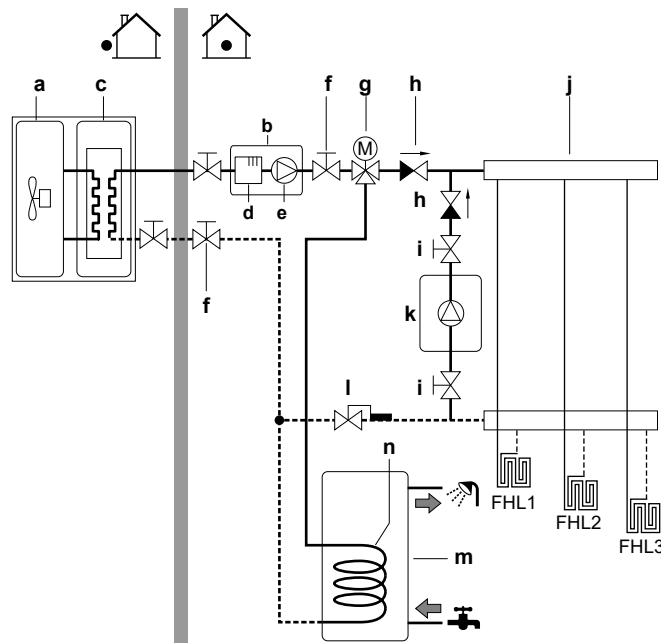

- a Outdoor unit
- b Indoor unit
- c Heat exchanger
- d Backup heater
- e Pump
- f Shut-off valve
- g Motorised 3-way valve
- h Non-return valve (field supply)
- i Shut-off valve (field supply)
- j Collector (field supply)
- k Auxiliary boiler (field supply)
- l Aquastat valve (field supply)
- m DHW tank (EHBH/X: option)
- n Heat exchanger coil

FHL1...3 Under floor heating**NOTICE**

- Make sure the auxiliary boiler and its integration in the system complies with applicable legislation.
- Daikin is NOT responsible for incorrect or unsafe situations in the auxiliary boiler system.

- Make sure the return water to the heat pump does NOT exceed 60°C. To do so:
 - Set the desired water temperature via the auxiliary boiler controller to maximum 60°C.
 - Install an aquastat valve in the return water flow of the heat pump. Set the aquastat valve to close above 60°C and to open below 60°C.
- Install non-return valves.
- An expansion vessel is already pre-mounted in the indoor unit. But for bivalent operation, also make sure that there is an expansion vessel in the auxiliary boiler loop. Otherwise when bivalent operation is running and if the Aquastat valve would close, there would be no expansion vessel in the water circuit anymore.
- Install the digital I/O PCB (option EKRP1HBAA).
- Connect X1 and X2 (changeover to external heat source) on the digital I/O PCB to the auxiliary boiler. See "9.3.8 To connect the changeover to external heat source" [▶ 95].
- To setup the heat emitters, see "6.2 Setting up the space heating/cooling system" [▶ 30].

Configuration

Via the user interface (configuration wizard):

- Set the use of a bivalent system as external heat source.
- Set the bivalent temperature and hysteresis.
- Set the operation mode to space heating only (no tank operation).

Changeover to external heat source decided by an auxiliary contact

- Only possible in external room thermostat control AND one leaving water temperature zone (see "6.2 Setting up the space heating/cooling system" [▶ 30]).
- The auxiliary contact can be:
 - An outdoor temperature thermostat
 - An electricity tariff contact
 - A manually operated contact
 - ...
- Setup: Connect the following field wiring:

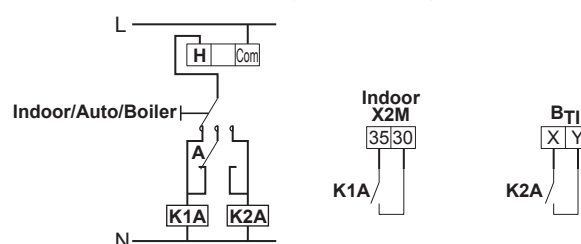

- B_{Ti}** Boiler thermostat input
- A** Auxiliary contact (normally closed)
- H** Heating demand room thermostat (optional)

- K1A** Auxiliary relay for activation of indoor unit (field supply)
- K2A** Auxiliary relay for activation of boiler (field supply)
- Indoor** Indoor unit
- Auto** Automatic
- Boiler** Boiler



NOTICE

- Make sure the auxiliary contact has enough differential or time delay to prevent frequent changeover between indoor unit and auxiliary boiler.
- If the auxiliary contact is an outdoor temperature thermostat, install the thermostat in the shadow so that it is NOT influenced or turned ON/OFF by direct sunlight.
- Frequent changeover may cause corrosion of the auxiliary boiler. Contact the manufacturer of the auxiliary boiler for more information.

Setpoint of the auxiliary gas boiler

To prevent freeze-up of the water piping, the auxiliary gas boiler must have a fixed setpoint $\geq 5^{\circ}\text{C}$, or a weather-dependent setpoint $\geq T_{\min}$.

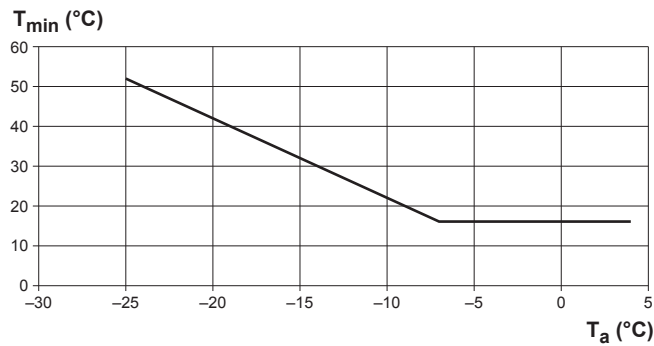

- T_a Outdoor temperature
- T_{\min} Minimum weather-dependent setpoint for auxiliary gas boiler

6.4 Setting up the domestic hot water tank

6.4.1 System layout – Integrated DHW tank

6.4.2 System layout – Standalone DHW tank

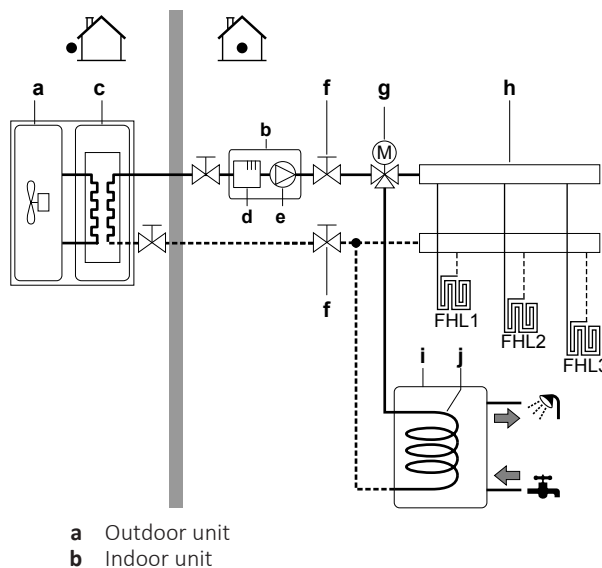

- c Heat exchanger
- d Backup heater
- e Pump
- f Shut-off valve
- g Motorised 3-way valve
- h Collector (field supply)
- i DHW tank
- j Heat exchanger coil
- FHL1...3** Under floor heating

6.4.3 Selecting the volume and desired temperature for the DHW tank

People experience water as hot when its temperature is 40°C. Therefore, the DHW consumption is always expressed as equivalent hot water volume at 40°C. However, you can set the DHW tank temperature at a higher temperature (example: 53°C), which is then mixed with cold water (example: 15°C).

Selecting the volume and desired temperature for the DHW tank consists of:

- 1 Determining the DHW consumption (equivalent hot water volume at 40°C).
- 2 Determining the volume and desired temperature for the DHW tank.

Determining the DHW consumption

Answer the following questions and calculate the DHW consumption (equivalent hot water volume at 40°C) using typical water volumes:

Question	Typical water volume
How many showers are needed per day?	1 shower = 10 min × 10 l/min = 100 l
How many baths are needed per day?	1 bath = 150 l
How much water is needed at the kitchen sink per day?	1 sink = 2 min × 5 l/min = 10 l
Are there any other domestic hot water needs?	—

Example: If the DHW consumption of a family (4 persons) per day is as follows:

- 3 showers
- 1 bath
- 3 sink volumes

Then the DHW consumption = (3 × 100 l) + (1 × 150 l) + (3 × 10 l) = 480 l

Determining the volume and desired temperature for the DHW tank

Formula	Example
$V_1 = V_2 + V_2 \times (T_2 - 40) / (40 - T_1)$	If: <ul style="list-style-type: none"> ▪ $V_2 = 180$ l ▪ $T_2 = 54^\circ\text{C}$ ▪ $T_1 = 15^\circ\text{C}$ Then $V_1 = 280$ l
$V_2 = V_1 \times (40 - T_1) / (T_2 - T_1)$	If: <ul style="list-style-type: none"> ▪ $V_1 = 480$ l ▪ $T_2 = 54^\circ\text{C}$ ▪ $T_1 = 15^\circ\text{C}$ Then $V_2 = 307$ l

- V_1 DHW consumption (equivalent hot water volume at 40°C)
 V_2 Required DHW tank volume if only heated once
 T_2 DHW tank temperature
 T_1 Cold water temperature

Possible DHW tank volumes

Type	Possible volumes
Standalone DHW tank	<ul style="list-style-type: none"> ▪ 150 l ▪ 180 l ▪ 200 l ▪ 250 l ▪ 300 l (polypropylene tank is compatible with solar kit) ▪ 500 l (compatible with solar kit)

Energy saving tips

- If the DHW consumption differs from day to day, you can program a weekly schedule with different desired DHW tank temperatures for each day.
- The lower the desired DHW tank temperature, the more cost effective. By selecting a larger DHW tank, you can lower the desired DHW tank temperature.
- The heat pump itself can produce domestic hot water of maximum 55°C (50°C if outdoor temperature is low). The electrical resistance integrated in the heat pump can increase this temperature. However, this consumes more energy. We recommend to set the desired DHW tank temperature below 55°C to avoid using the electrical resistance.
- The higher the outdoor temperature, the better the performance of the heat pump.
 - If energy prices are the same during the day and the night, we recommend to heat up the DHW tank during the day.
 - If energy prices are lower during the night, we recommend to heat up the DHW tank during the night.
- When the heat pump produces domestic hot water, it cannot heat up a space. In case you need domestic hot water and space heating at the same, we recommend to produce the domestic hot water during the night when there is lower space heating demand.

6.4.4 Setup and configuration – DHW tank

- For large DHW consumptions, you can heat up the DHW tank several times during the day.
- To heat up the DHW tank to the desired DHW tank temperature, you can use the following energy sources:
 - Thermodynamic cycle of the heat pump
 - Electrical booster heater

- For more information about:
 - Optimizing the energy consumption for producing domestic hot water, see ["10 Configuration"](#) [▶ 99].
 - Connecting the electrical wiring of the standalone DHW tank to the indoor unit, see the installation manual of the DHW tank, and the addendum book for optional equipment.
 - Connecting the water piping of the standalone DHW tank to the indoor unit, see the installation manual of the DHW tank.

6.4.5 DHW pump for instant hot water

Setup

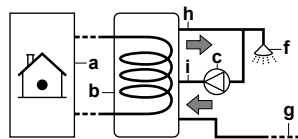

- a** Indoor unit
- b** DHW tank
- c** DHW pump (field supply)
- f** Shower (field supply)
- g** Cold water
- h** Domestic hot water OUT
- i** Recirculation connection

- By connecting a DHW pump, instant hot water can be available at the tap.
- The DHW pump and the installation are field supply and the responsibility of the installer. For the electrical wiring, see ["9.3.5 To connect the domestic hot water pump"](#) [▶ 93].
- For more information about connecting the recirculation connection, see the installation manual of the domestic hot water tank.

Configuration

- For more information, see ["10 Configuration"](#) [▶ 99].
- You can program a schedule to control the DHW pump via the user interface. For more information, see the user reference guide.

6.4.6 DHW pump for disinfection

Setup

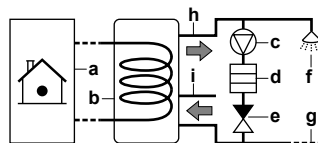

- a** Indoor unit
- b** DHW tank
- c** DHW pump (field supply)
- d** Heater element (field supply)
- e** Non-return valve (field supply)
- f** Shower (field supply)
- g** Cold water
- h** Domestic hot water OUT
- i** Recirculation connection

- The DHW pump is field-supplied and its installation is the responsibility of the installer. For the electrical wiring, see ["9.3.5 To connect the domestic hot water pump"](#) [▶ 93].

- If the applicable legislation requires a higher temperature than the maximum tank setpoint during disinfection (see [2-03] in the field settings table), you can connect a DHW pump and heater element as shown above.
- If applicable legislation requires disinfection of the water piping until the tapping point, you can connect a DHW pump and heater element (if needed) as shown above.

Configuration

The indoor unit can control DHW pump operation. For more information, see "10 Configuration" [▶ 99].

6.4.7 DHW pump for tank preheating

Setup

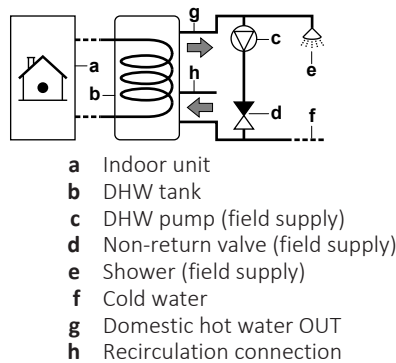

- The DHW pump is field-supplied and its installation is the responsibility of the installer. For the electrical wiring, see "9.3.5 To connect the domestic hot water pump" [▶ 93].
- For the standalone DHW tank: If there is no electrical backup heater in the space heating circuit, you must install a DHW pump for tank preheating.

Configuration

The indoor unit can control DHW pump operation. For more information, see "10 Configuration" [▶ 99].

6.5 Setting up the energy metering

- Via the user interface, you can read out the following energy data:
 - Produced heat
 - Consumed energy
- You can read out the energy data:
 - For space heating
 - For space cooling
 - For domestic hot water production
- You can read out the energy data:
 - Per month
 - Per year

**INFORMATION**

The calculated produced heat and consumed energy are an estimation, the accuracy cannot be guaranteed.

6.5.1 Produced heat

**INFORMATION**

The sensors used to calculate the produced heat are calibrated automatically.

**INFORMATION**

If glycol is present in the system ([E-0D]=1]), then the produced heat will NOT be calculated, nor will it be displayed on the user interface.

- The produced heat is calculated internally based on:
 - The leaving and entering water temperature
 - The flow rate
 - The power consumption of the booster heater (if applicable) in the domestic hot water tank
- Setup and configuration:
 - No additional equipment needed.
 - Only in case a booster heater is present in the system, measure its capacity (resistance measurement) and set the capacity via the user interface. **Example:** If you measure a booster heater resistance of 17.1Ω, the capacity of the heater at 230 V is 3100 W.

6.5.2 Consumed energy

You can use the following methods to determine the consumed energy:

- Calculating
- Measuring

**INFORMATION**

You cannot combine calculating the consumed energy (example: for backup heater) and measuring the consumed energy (example: for outdoor unit). If you do so, the energy data will be invalid.

Calculating the consumed energy

- The consumed energy is calculated internally based on:
 - The actual power input of the outdoor unit
 - The set capacity of the backup heater and booster heater (if applicable)
 - The voltage
- Setup and configuration: To get accurate energy data, measure the capacity (resistance measurement) and set the capacity via the user interface for:
 - The backup heater (step 1 and step 2) (if applicable)
 - The booster heater

Measuring the consumed energy

- Preferred method because of higher accuracy.
- Requires external power meters.
- Setup and configuration: When using electrical power meters, set the number of pulses/kWh for each power meter via the user interface.



INFORMATION

When measuring the electrical power consumption, make sure ALL power input of the system is covered by the electrical power meters.

6.5.3 Normal kWh rate power supply

General rule

One power meter that covers the entire system is sufficient.

Setup

Connect the power meter to X5M/5 and X5M/6. See "9.3.4 To connect the electricity meters" [▶ 93].

Power meter type

In case of...	Use a... power meter
<ul style="list-style-type: none"> ▪ Single-phase outdoor unit ▪ Backup heater supplied from a single-phase grid (i.e. the backup heater model is *3V or *6V connected to a single-phase grid) 	Single-phase (*3V, *6V (6V): 1N~ 230 V)
<ul style="list-style-type: none"> ▪ Three-phase outdoor unit ▪ Backup heater supplied from a three-phase grid (i.e. the backup heater model is *9W or *6V connected to a three-phase grid) 	Three-phase (*6V (6T1): 3~ 230 V) (*9W: 3N~ 400 V)

Example

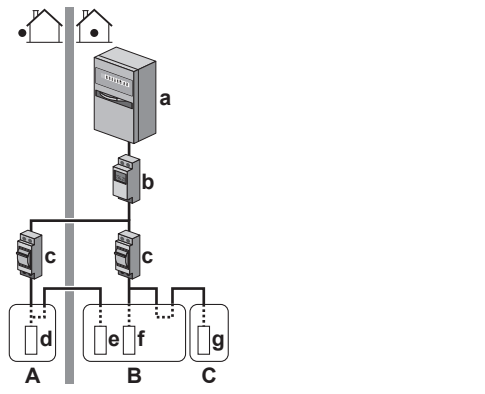
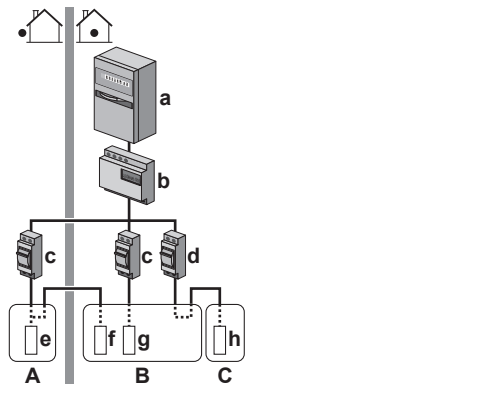
Single-phase power meter	Three-phase power meter
 <p>A Outdoor unit B Indoor unit C DHW tank a Electrical cabinet (L₁/N) b Power meter (L₁/N) c Fuse (L₁/N) d Outdoor unit (L₁/N) e Indoor unit (L₁/N) f Backup heater (L₁/N) g Booster heater (L₁/N)</p>	 <p>A Outdoor unit B Indoor unit C DHW tank a Electrical cabinet (L₁/L₂/L₃/N) b Power meter (L₁/L₂/L₃/N) c Fuse (L₁/L₂/L₃/N) d Fuse (L₁/N) e Outdoor unit (L₁/L₂/L₃/N) f Indoor unit (L₁/L₂/L₃/N) g Backup heater (L₁/L₂/L₃/N) h Booster heater (L₁/N)</p>

Exception

- You can use a second power meter if:
 - The power range of one meter is insufficient.
 - The electrical meter cannot easily be installed in the electrical cabinet.
 - 230 V and 400 V three-phase grids are combined (very uncommon), because of technical limitations of power meters.
- Connection and setup:
 - Connect the second power meter to X5M/3 and X5M/4. See ["9.3.4 To connect the electricity meters"](#) [▶ 93].
 - In the software the power consumption data of both meters is added so you do NOT have to set which meter covers which power consumption. You only need to set the number of pulses of each power meter.
- See ["6.5.4 Preferential kWh rate power supply"](#) [▶ 51] for an example with two power meters.

6.5.4 Preferential kWh rate power supply

General rule

- Power meter 1: Measures the outdoor unit.
- Power meter 2: Measures the rest (i.e. indoor unit, backup heater and optional booster heater).

Setup

- Connect power meter 1 to X5M/5 and X5M/6.
- Connect power meter 2 to X5M/3 and X5M/4.

See "9.3.4 To connect the electricity meters" [► 93].

Power meter types

- Power meter 1: Single- or three-phase power meter according to the power supply of the outdoor unit.
- Power meter 2:
 - In case of a single-phase backup heater configuration, use a single-phase power meter.
 - In other cases, use a three-phase power meter.

Example

Single-phase outdoor unit with a three-phase backup heater:

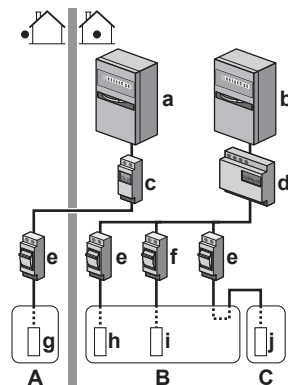

- A Outdoor unit
- B Indoor unit
- C DHW tank
- a Electrical cabinet (L₁/N): Preferential kWh rate power supply
- b Electrical cabinet (L₁/L₂/L₃/N): Normal kWh rate power supply
- c Power meter (L₁/N)
- d Power meter (L₁/L₂/L₃/N)
- e Fuse (L₁/N)
- f Fuse (L₁/L₂/L₃/N)
- g Outdoor unit (L₁/N)
- h Indoor unit (L₁/N)
- i Backup heater (L₁/L₂/L₃/N)
- j Booster heater (L₁/N)

6.6 Setting up the power consumption control

- The power consumption control:
 - Allows you to limit the power consumption of the entire system (sum of outdoor unit, indoor unit, backup heater and optional booster heater).
 - Configuration: Set the power limitation level and how it has to be achieved via the user interface.
- The power limitation level can be expressed as:
 - Maximum running current (in A)
 - Maximum power input (in kW)

- The power limitation level can be activated:
 - Permanently
 - By digital inputs

**NOTICE**

It is possible to install a field fuse with lower than recommended rating over the heat pump. For this you must modify field setting [2-0E] according to the maximum allowed current over the heat pump.

Note that field setting [2-0E] overrides all power consumption control settings. Power limiting the heat pump will reduce performance.

**NOTICE**

Set a minimum power consumption of ± 3.6 kW to guarantee:

- Defrost operation. Otherwise, if defrosting is interrupted several times, the heat exchanger will freeze up.
- Space heating and DHW production by allowing the backup heater step 1.

6.6.1 Permanent power limitation

Permanent power limitation is useful to assure a maximum power or current input of the system. In some countries, legislation limits the maximum power consumption for space heating and DHW production.

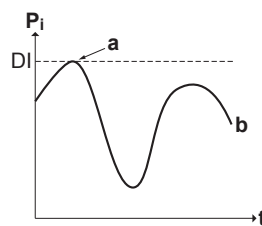

- P_i Power input
- t Time
- DI Digital input (power limitation level)
- a Power limitation active
- b Actual power input

Setup and configuration

- No additional equipment needed.
- Set the power consumption control settings in [9.9] via the user interface (see "Power consumption control" [▶ 158]):
 - Select continuous limitation mode
 - Select the type of limitation (power in kW or current in A)
 - Set the desired power limitation level

6.6.2 Power limitation activated by digital inputs

Power limitation is also useful in combination with an energy management system. The power or current of the entire Daikin system is limited dynamically by digital inputs (maximum four steps). Each power limitation level is set via the user interface by limiting one of the following:

- Current (in A)
- Power input (in kW)

The energy management system (field supply) decides the activation of a certain power limitation level. **Example:** To limit the maximum power of the entire house (lighting, domestic appliances, space heating...).

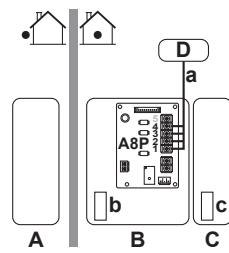

- A** Outdoor unit
- B** Indoor unit
- C** DHW tank
- D** Energy management system
- a** Power limitation activation (4 digital inputs)
- b** Backup heater
- c** Booster heater

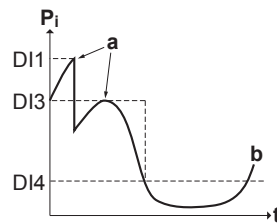

- P_i** Power input
- t** Time
- DI** Digital inputs (power limitation levels)
- a** Power limitation active
- b** Actual power input

Setup

- Demand PCB (option EKRP1AHTA) needed.
- Maximum four digital inputs are used to activate the corresponding power limitation level:
 - DI1 = strongest limitation (lowest energy consumption)
 - DI4 = weakest limitation (highest energy consumption)
- Specification of the digital inputs:
 - DI1: S9S (limit 1)
 - DI2: S8S (limit 2)
 - DI3: S7S (limit 3)
 - DI4: S6S (limit 4)
- Refer to the wiring diagram for more information.

Configuration

- Set the power consumption control settings in [9.9] via the user interface (for the description of all settings, see "[Power consumption control](#)" [▶ 158]):
 - Select limitation by digital inputs.
 - Select the type of limitation (power in kW or current in A).
 - Set the desired power limitation level corresponding to each digital input.

**INFORMATION**

In case more than 1 digital input is closed (at the same time), the digital input priority is fixed: DI4 priority > ... > DI1.

6.6.3 Power limitation process

The outdoor unit has better efficiency than the electrical heaters. Therefore, the electrical heaters are limited and turned OFF first. The system limits power consumption in the following order:

- 1 Limits certain electrical heaters.

If... has priority	Then set the priority heater via the user interface to...
Domestic hot water production	Booster heater (if applicable) Result: The backup heater will be turned OFF first.
Space heating	Backup heater Result: The booster heater (if applicable) will be turned OFF first.

- 2 Turns OFF all electrical heaters.
- 3 Limits the outdoor unit.
- 4 Turns OFF the outdoor unit.

Example

If the configuration is as follows:

- Power limitation level does NOT allow operation of both booster heater and backup heater (step 1 and step 2).
- Priority heater = **Booster heater** (if applicable).

Then power consumption is limited as follows:

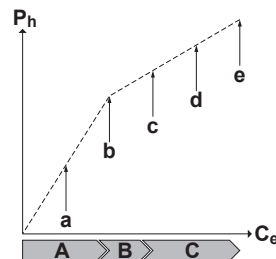

- P_h Produced heat
- C_e Consumed energy
- A** Outdoor unit
- B** Booster heater
- C** Backup heater
- a** Limited outdoor unit operation
- b** Full outdoor unit operation
- c** Booster heater turned ON
- d** Backup heater step 1 turned ON
- e** Backup heater step 2 turned ON

6.7 Setting up an external temperature sensor

You can connect one external temperature sensor. It measures the indoor or outdoor ambient temperature. We recommend to use an external temperature sensor in the following cases:

Indoor ambient temperature

- In room thermostat control, the user interface used as room thermostat (BRC1H) measures the indoor ambient temperature. Therefore, the user interface used as room thermostat must be installed on a location:
 - Where the average temperature in the room can be detected
 - That is NOT exposed to direct sunlight
 - That is NOT near a heat source
 - That is NOT affected by outside air or air draught because of, for example, door opening/closing
- If this is NOT possible, we recommend to connect a remote indoor sensor (option KRCS01-1).
- Setup: For installation instructions, see the installation manual of the remote indoor sensor, and the addendum book for optional equipment.
- Configuration: Select room sensor [9.B].

Outdoor ambient temperature

- In the outdoor unit, the outdoor ambient temperature is measured. Therefore, the outdoor unit must be installed on a location:
 - At the north side of the house or at the side of the house where the most heat emitters are located
 - That is NOT exposed to direct sunlight
- If this is NOT possible, we recommend to connect a remote outdoor sensor (option EKRSCA1).
- Setup: For installation instructions, see the installation manual of the remote outdoor sensor, and the addendum book for optional equipment.
- Configuration: Select outdoor sensor [9.B].
- When the power saving functionality of the outdoor unit is active (see "[Power saving function](#)" [▶ 165]), the outdoor unit is turned down to reduce standby energy losses. As a result, the outdoor ambient temperature is NOT read out.
- If the desired leaving water temperature is weather dependent, the full time outdoor temperature measurement is important. This is another reason to install the optional outdoor ambient temperature sensor.



INFORMATION

The external outdoor ambient sensor data (either averaged or instantaneous) is used in the weather-dependent control curves and in the automatic heating/cooling changeover logic. To protect the outdoor unit, the internal sensor of the outdoor unit is always used.

7 Unit installation

In this chapter

7.1	Preparing the installation site	57
7.1.1	Installation site requirements of the outdoor unit	57
7.1.2	Additional installation site requirements of the outdoor unit in cold climates	60
7.1.3	Installation site requirements of the indoor unit	60
7.2	Opening and closing the units	61
7.2.1	About opening the units	61
7.2.2	To open the outdoor unit	62
7.2.3	To remove the transportation stay	62
7.2.4	To close the outdoor unit	63
7.2.5	To open the indoor unit	63
7.2.6	To close the indoor unit	65
7.3	Mounting the outdoor unit	65
7.3.1	About mounting the outdoor unit	65
7.3.2	Precautions when mounting the outdoor unit	66
7.3.3	To provide the installation structure	66
7.3.4	To install the outdoor unit	66
7.3.5	To provide drainage	67
7.4	Mounting the indoor unit	68
7.4.1	About mounting the indoor unit	68
7.4.2	Precautions when mounting the indoor unit	68
7.4.3	To install the indoor unit	68
7.4.4	To connect the drain hose to the drain	69

7.1 Preparing the installation site

Choose an installation location with sufficient space for carrying the unit in and out of the site.

Do NOT install the unit in places often used as work place. In case of construction works (e.g. grinding works) where a lot of dust is created, the unit MUST be covered.



WARNING

The appliance shall be stored in a room without continuously operating ignition sources (example: open flames, an operating gas appliance or an operating electric heater).

7.1.1 Installation site requirements of the outdoor unit



INFORMATION

Also read the precautions and requirements in the "[2 General safety precautions](#)" [[▶ 10](#)].

Mind the spacing guidelines. See "[16.1 Service space: Outdoor unit](#)" [[▶ 202](#)].



NOTICE

- Do NOT stack the units on each other.
- Do NOT hang the unit on a ceiling.

Strong winds (≥ 18 km/h) blowing against the outdoor unit's air outlet causes short circuit (suction of discharge air). This may result in:

- deterioration of the operational capacity;

- frequent frost acceleration in heating operation;
- disruption of operation due to decrease of low pressure or increase of high pressure;
- a broken fan (if a strong wind blows continuously on the fan, it may start rotating very fast, until it breaks).

It is recommended to install a baffle plate when the air outlet is exposed to wind.

It is recommended to install the outdoor unit with the air inlet facing the wall and NOT directly exposed to the wind.

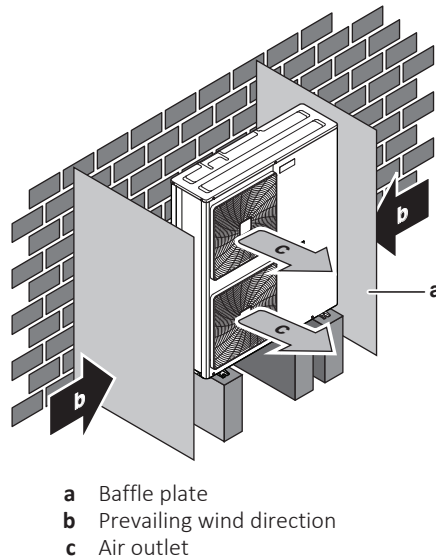

Do NOT install the unit in the following places:

- Sound sensitive areas (e.g. near a bedroom), so that the operation noise will cause no trouble.

Note: If the sound is measured under actual installation conditions, the measured value might be higher than the sound pressure level mentioned in Sound spectrum in the data book due to environmental noise and sound reflections.

- In places where a mineral oil mist, spray or vapour may be present in the atmosphere. Plastic parts may deteriorate and fall off or cause water leakage.

It is NOT recommended to install the unit in the following places because it may shorten the life of the unit:

- Where the voltage fluctuates a lot
- In vehicles or vessels
- Where acidic or alkaline vapour is present

Seaside installation. Make sure the outdoor unit is NOT directly exposed to sea winds. This is to prevent corrosion caused by high levels of salt in the air, which might shorten the life of the unit.

Install the outdoor unit away from direct sea winds.

Example: Behind the building.

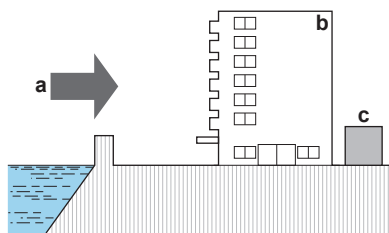

If the outdoor unit is exposed to direct sea winds, install a windbreaker.

- Height of windbreaker $\geq 1.5 \times$ height of outdoor unit
- Mind the service space requirements when installing the windbreaker.

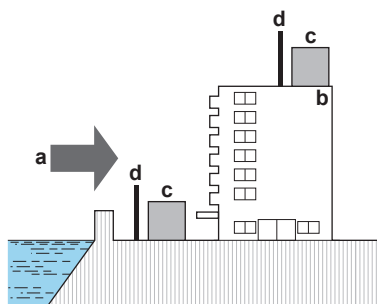

- a Sea wind
- b Building
- c Outdoor unit
- d Windbreaker

The outdoor unit is designed for outdoor installation only, and for the following ambient temperatures:

Cooling mode	10~43°C
Heating mode	-28~35°C

Special requirements for R32

The outdoor unit contains an internal refrigerant circuit (R32), but you do NOT have to do any refrigerant field piping, or refrigerant charging.

Mind the following requirements and precautions:



WARNING

- Do NOT pierce or burn refrigerant cycle parts.
- Do NOT use means to accelerate the defrosting process or to clean the equipment, other than those recommended by the manufacturer.
- Be aware that R32 refrigerant does NOT contain an odour.



WARNING

The appliance shall be stored so as to prevent mechanical damage and in a well-ventilated room without continuously operating ignition sources (example: open flames, an operating gas appliance or an operating electric heater).



WARNING

Make sure installation, servicing, maintenance and repair comply with instructions from Daikin and with applicable legislation and are executed ONLY by authorised persons.

7.1.2 Additional installation site requirements of the outdoor unit in cold climates

Protect the outdoor unit against direct snowfall and take care that the outdoor unit is NEVER snowed up.

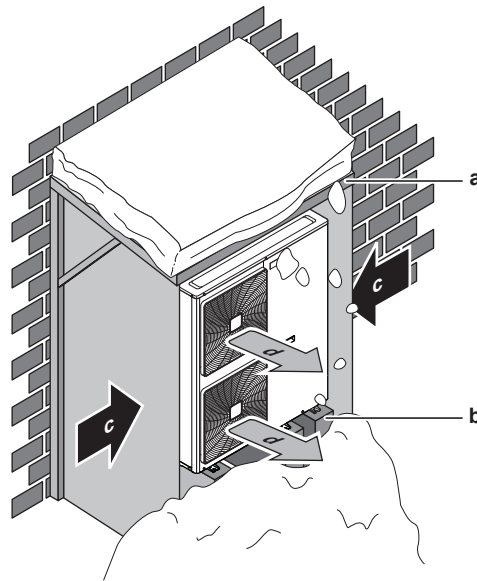

- a** Snow cover or shed
- b** Pedestal
- c** Prevailing wind direction
- d** Air outlet

In any case, provide at least 150 mm of free space below the unit. Additionally, make sure the unit is positioned at least 100 mm above the maximum expected level of snow. See "7.3 Mounting the outdoor unit" [▶ 65] for more details.

In heavy snowfall areas it is very important to select an installation site where the snow will NOT affect the unit. If lateral snowfall is possible, make sure that the heat exchanger coil is NOT affected by the snow. If necessary, install a snow cover or shed and a pedestal.

7.1.3 Installation site requirements of the indoor unit



INFORMATION

Also read the precautions and requirements in the "2 General safety precautions" [▶ 10].

- The indoor unit is designed for indoor installation only and for the following ambient temperatures:
 - Space heating operation: 5~30°C
 - Space cooling operation: 5~35°C
 - Domestic hot water production: 5~35°C



INFORMATION

Cooling is only applicable in case of:

- Reversible models
 - Heating only models + conversion kit (EKHBCONV*)
- Mind the measurement guidelines:

Maximum height difference between indoor unit and outdoor unit	10 m
Maximum height difference between domestic hot water tank and outdoor unit	10 m
Maximum water piping length between indoor unit and domestic hot water tank	10 m
Maximum distance between the 3-way valve and the indoor unit (for installations with domestic hot water tank)	3 m
Maximum total water piping length	50 m ^(a)

^(a) Precise water piping length can be determined using the Hydronic Piping Calculation tool. The Hydronic Piping Calculation tool is part of the Heating Solutions Navigator which can be reached via <https://professional.standbyme.daikin.eu>. Please contact your dealer if you have no access to Heating Solutions Navigator.

- Mind the following spacing installation guidelines:

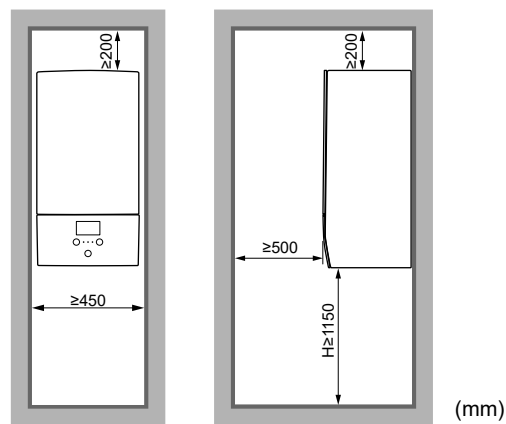

H Height measured from the bottom of the casing to the floor

Do NOT install the unit in places such as:

- In places where a mineral oil mist, spray or vapour may be present in the atmosphere. Plastic parts may deteriorate and fall off or cause water leakage.
- Sound sensitive areas (e.g. near a bedroom), so that the operation noise will cause no trouble.
- In places with high humidity (max. RH=85%), for example a bathroom.
- In places where frost is possible. Ambient temperature around the indoor unit must be $>5^{\circ}\text{C}$.

7.2 Opening and closing the units

7.2.1 About opening the units

At certain times, you have to open the unit. **Example:**

- When connecting the electrical wiring
- When maintaining or servicing the unit



DANGER: RISK OF ELECTROCUTION

Do NOT leave the unit unattended when the service cover is removed.

7.2.2 To open the outdoor unit



DANGER: RISK OF ELECTROCUTION



DANGER: RISK OF BURNING/SCALDING

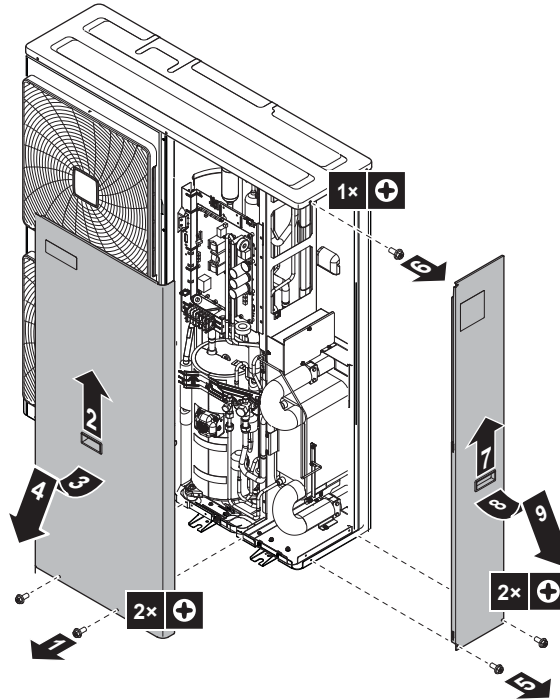

7.2.3 To remove the transportation stay



NOTICE

If the unit is operated with the transportation stay attached, abnormal vibration or noise may be generated.

The compressor transportation stay must be removed. It is installed under the compressor leg in order to protect the unit during transport. Proceed as shown in the figure and procedure below.

- 1 Remove the nut (a) of the compressor mounting bolt.
- 2 Remove and discard the transportation stay (b).
- 3 Re-install the nut (a) of the compressor mounting bolt and tighten to 10.1 N•m of torque.

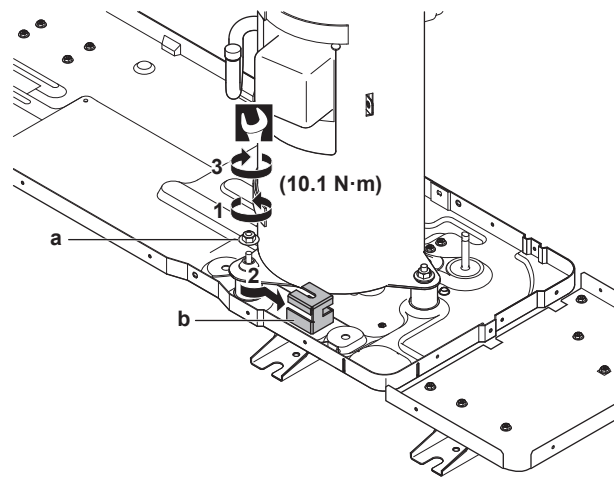

7.2.4 To close the outdoor unit

- 1 Close the switch box cover.
- 2 Mount the front plate and the side plate.



NOTICE

When closing the outdoor unit cover, make sure that the tightening torque does NOT exceed 4.1 N•m.

7.2.5 To open the indoor unit

Overview

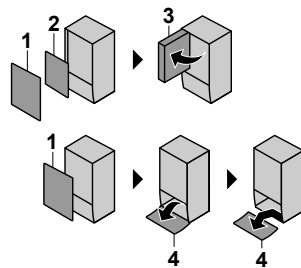

- 1 Front panel
- 2 Switch box cover
- 3 Switch box
- 4 User interface panel

Open

- 1 Remove the front panel.

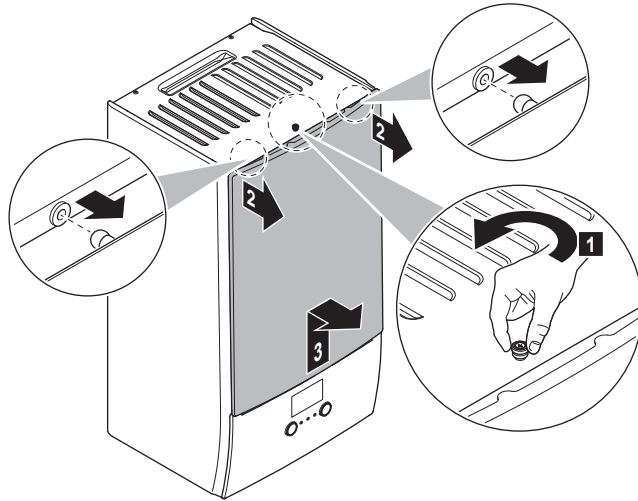

- 2 If you have to connect electrical wiring, remove the switch box cover.

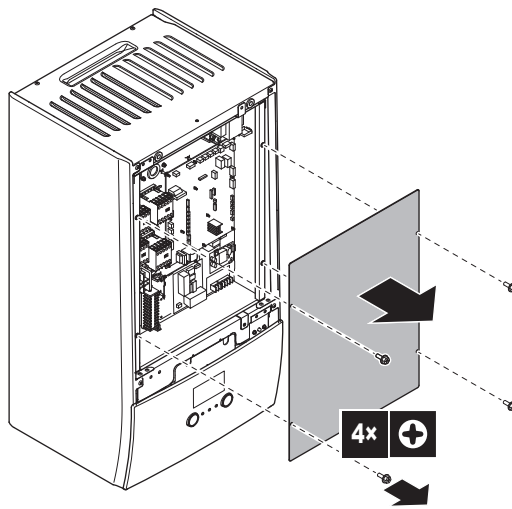

- 3 If you have to do work behind the switch box, open the switch box.

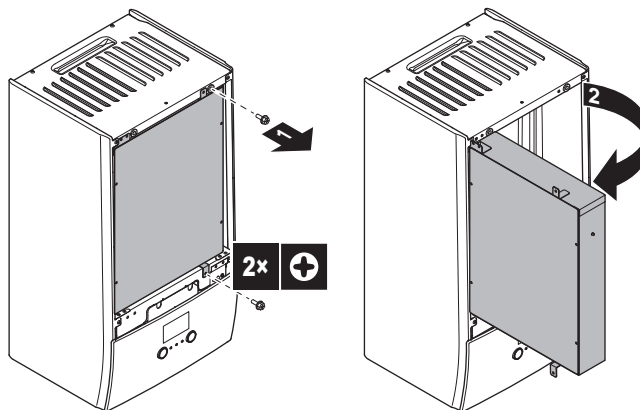

- 4 If you have to do work behind the user interface panel or upload new software into the user interface, open the user interface panel.

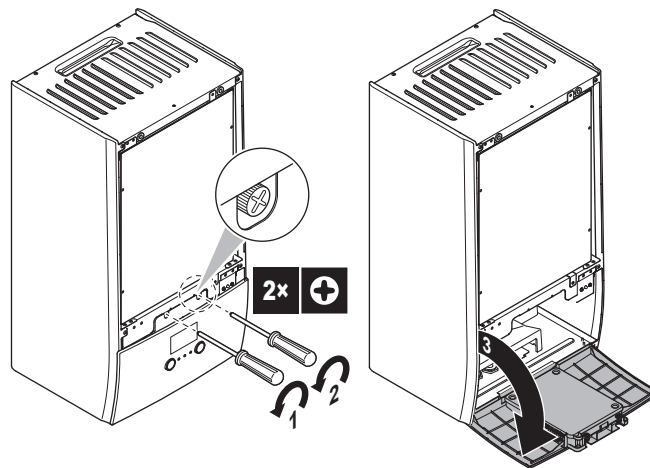

5 Optional: Remove the user interface panel.



NOTICE

If you remove the user interface panel, also disconnect the cables from the back of the user interface panel to prevent damage.

7.2.6 To close the indoor unit

- 1 Reinstall the user interface panel.
- 2 Reinstall the switch box cover and close the switch box.
- 3 Reinstall the front panel.



NOTICE

When closing the indoor unit cover, make sure that the tightening torque does NOT exceed 4.1 N•m.

7.3 Mounting the outdoor unit

7.3.1 About mounting the outdoor unit

When

You have to mount the outdoor unit before you can connect the water piping.

Typical workflow

Mounting the outdoor unit typically consists of the following stages:

- 1 Providing the installation structure.
- 2 Installing the outdoor unit.
- 3 Preventing the unit from falling over.
- 4 Protecting the unit against snow and wind by installing a snow cover and baffle plates. See "[7.1 Preparing the installation site](#)" [▶ 57].

7.3.2 Precautions when mounting the outdoor unit



INFORMATION

Also read the precautions and requirements in the following chapters:

- General safety precautions
- Preparation

7.3.3 To provide the installation structure

Check the strength and level of the installation ground so that the unit will not cause any operating vibration or noise.

Fix the unit securely by means of foundation bolts in accordance with the foundation drawing.

Prepare 6 sets of anchor bolts, nuts and washers (field supply) as follows:

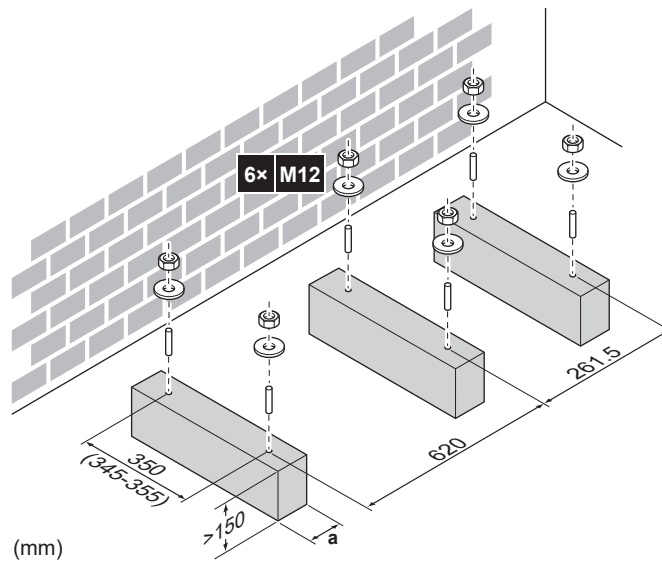

a Make sure not to cover the drain holes.

In any case, make sure the unit is positioned at least 100 mm above the maximum expected level of snow.

7.3.4 To install the outdoor unit

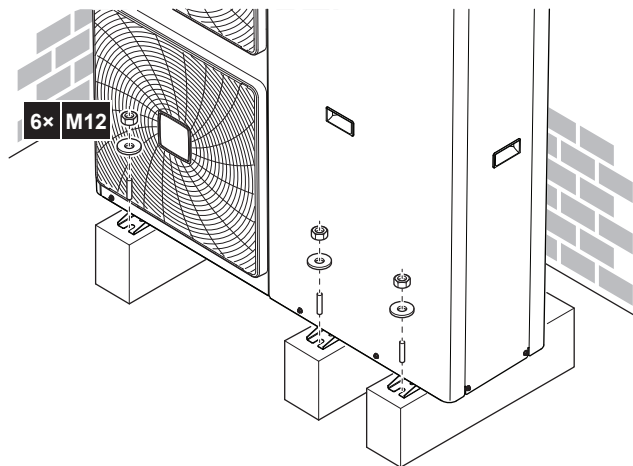

7.3.5 To provide drainage

- Make sure that condensation water can be evacuated properly.
- Install the unit on a base to make sure that there is proper drainage in order to avoid ice accumulation.
- Prepare a water drainage channel around the foundation to drain waste water away from the unit.
- Avoid drain water flowing over the footpath, so that it does NOT become slippery in case of ambient freezing temperatures.
- If you install the unit on a frame, install a waterproof plate within 150 mm of the bottom side of the unit in order to prevent water from getting into the unit and to avoid drain water dripping (see the following figure).

**NOTICE**

If the unit is installed in a cold climate, take adequate measures so that the evacuated condensate CANNOT freeze.

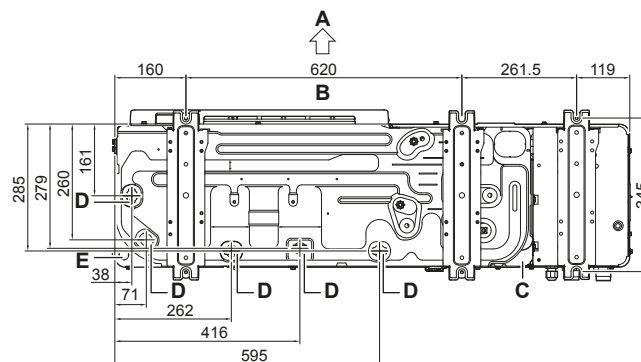
Drain holes (dimensions in mm)

- A Discharge side
- B Distance between anchor points
- C Bottom frame
- D Drain holes
- E Knockout hole for snow

**NOTICE**

If drain holes of the outdoor unit are covered by a mounting base or by floor surface, raise the unit to provide a free space of more than 150 mm under the outdoor unit.

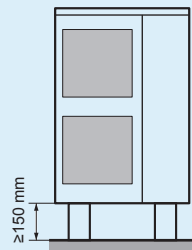

7.4 Mounting the indoor unit

7.4.1 About mounting the indoor unit

Typical workflow

Mounting the indoor unit typically consists of the following stages:

- 1 Installing the indoor unit.

7.4.2 Precautions when mounting the indoor unit



INFORMATION

Also read the precautions and requirements in the following chapters:

- General safety precautions
- Preparation

7.4.3 To install the indoor unit

- 1 Fix the wall bracket (accessory) to the wall (level) with 2× Ø8 mm bolts.

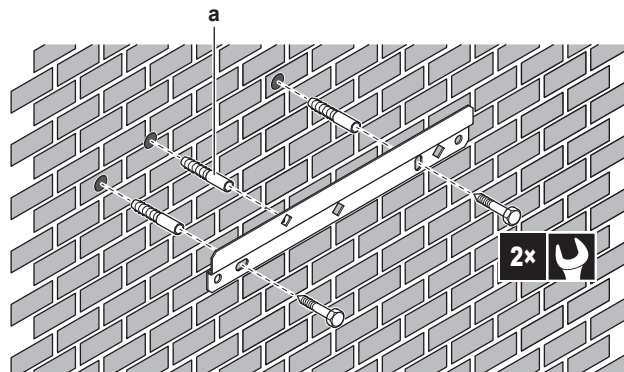

- a** Optional: If you want to fix the unit to the wall from inside the unit, provide an additional screw plug.

- 2 Lift the unit.

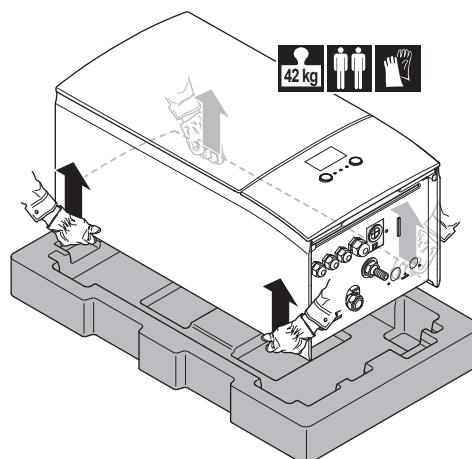

- 3 Attach the unit to the wall bracket:
 - Tilt the top of the unit against the wall at the position of the wall bracket.
 - Slide the bracket on the back of the unit over the wall bracket. Make sure the unit is fixed properly.

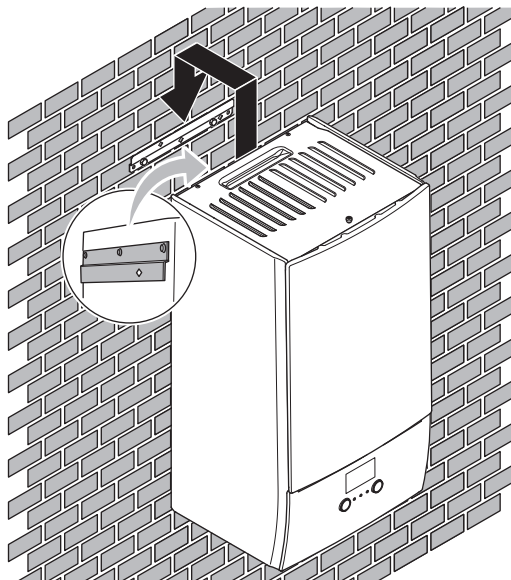

- 4** Optional: If you want to fix the unit to the wall from inside the unit:
- Remove the upper front panel, and open the switch box. See "7.2.5 To open the indoor unit" [▶ 63].
 - Fix the unit to the wall with an $\varnothing 8$ mm screw.

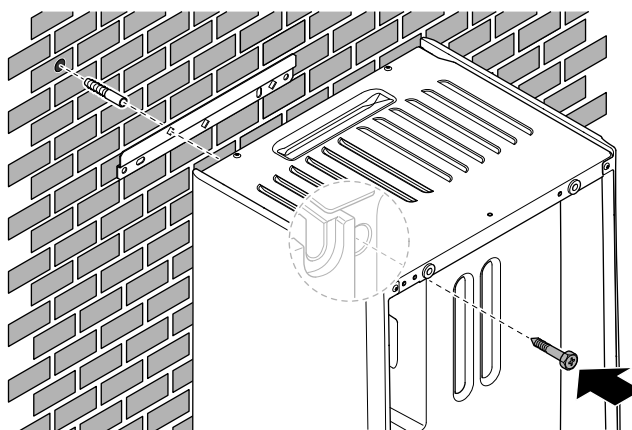

7.4.4 To connect the drain hose to the drain

Water coming from the pressure relief valve is collected in the drain pan. You must connect the drain pan to an appropriate drain according to the applicable legislation.

- 1** Connect a drain tube (field supply) to the drain pan connector as follows:

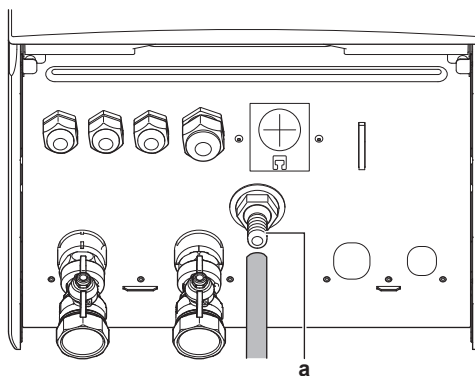

a Drain pan connector

It is recommended to use a tundish to collect the water.

8 Piping installation

In this chapter

8.1	Preparing water piping	70
8.1.1	Water circuit requirements	70
8.1.2	Formula to calculate the expansion vessel pre-pressure.....	73
8.1.3	To check the water volume and flow rate.....	73
8.1.4	Changing the pre-pressure of the expansion vessel	76
8.1.5	To check the water volume: Examples	76
8.2	Connecting water piping	77
8.2.1	About connecting the water piping	77
8.2.2	Precautions when connecting the water piping.....	77
8.2.3	To connect the water piping.....	77
8.2.4	To fill the water circuit	79
8.2.5	To protect the water circuit against freezing	80
8.2.6	To fill the domestic hot water tank.....	83
8.2.7	To insulate the water piping	83

8.1 Preparing water piping

- **Valve towards expansion vessel.** The valve towards the expansion vessel (if equipped) **MUST** be open.

8.1.1 Water circuit requirements



INFORMATION

Also read the precautions and requirements in the "[2 General safety precautions](#)" [▶ 10].



NOTICE

In case of plastic pipes, make sure they are fully oxygen diffusion tight according to DIN 4726. The diffusion of oxygen into the piping can lead to excessive corrosion.

- **Connecting piping – Legislation.** Make all piping connections in accordance with the applicable legislation and the instructions in the "Installation" chapter, respecting the water inlet and outlet.
- **Connecting piping – Force.** Do NOT use excessive force when connecting the piping. Deformation of the piping can cause malfunctioning of the unit.
- **Connecting piping – Tools.** Only use appropriate tooling to handle brass, which is a soft material. If NOT, pipes will get damaged.

- **Connecting piping – Air, moisture, dust.** If air, moisture or dust gets into the circuit, problems may occur. To prevent this:
 - ONLY use clean pipes.
 - Hold the pipe end downwards when removing burrs.
 - Cover the pipe end when inserting it through a wall, to prevent dust and/or particles from entering the pipe.
 - Use a decent thread sealant to seal connections.
 - When using non-brass metallic piping, make sure to insulate both materials from each other to prevent galvanic corrosion.
 - Because brass is a soft material, use appropriate tooling for connecting the water circuit. Inappropriate tooling will cause damage to the pipes.
- **Insulation.** Insulate up to the base of the heat exchanger.
- **Freeze.** Protect against freezing.
- **Closed circuit.** Use the indoor unit ONLY in a closed water system. Using the system in an open water system will lead to excessive corrosion.
- **Piping length.** It is recommended to avoid long runs of piping between the domestic hot water tank and the hot water end point (shower, bath,...) and to avoid dead ends.
- **Piping diameter.** Select the water piping diameter in relation to the required water flow and the available external static pressure of the pump. See "[16 Technical data](#)" [▶ 202] for the external static pressure curves of the indoor unit.
- **Water flow.** You can find the minimum required water flow for indoor unit operation in the following table. In all cases, this flow needs to be guaranteed. When the flow is lower, the indoor unit will stop operation and display error 7H.

Minimum required flow rate

20 l/min

- **Field supply components – Water.** Only use materials that are compatible with water used in the system and with the materials used in the indoor unit.
- **Field supply components – Water pressure and temperature.** Check that all components in the field piping can withstand the water pressure and water temperature.
- **Water temperature.** All installed piping and piping accessories (valve, connections,...) MUST withstand the following temperatures:

**INFORMATION**

The following illustration is an example and might NOT match your system layout.

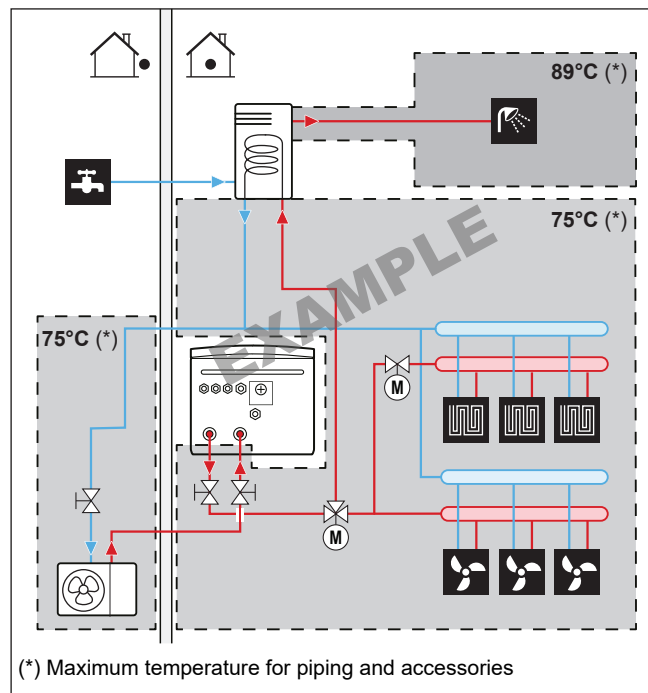

- **Drainage – Low points.** Provide drain taps at all low points of the system in order to allow complete drainage of the water circuit.
- **Drainage – Pressure relief valve.** Connect the drain hose properly to the drain to avoid water dripping out of the unit. See "[7.4.4 To connect the drain hose to the drain](#)" [▶ 69].
- **Air vents.** Provide air vents at all high points of the system, which must also be easily accessible for servicing. Two automatic air purges are provided in the indoor unit. Check that the air purges are NOT tightened too much, so that automatic release of air in the water circuit is possible.
- **Zn-coated parts.** NEVER use zinc coated parts in the water circuit. Because the internal water circuit of the unit uses copper piping, excessive corrosion may occur.
- **Non-brass metallic piping.** When using non-brass metallic piping, insulate the brass and non-brass properly so that they do NOT make contact with each other. This to prevent galvanic corrosion.
- **Valve – Separating circuits.** When using a 3-way valve in the water circuit make sure that the domestic hot water circuit and the floor heating circuit are fully separated.
- **Valve – Change-over time.** When using a 2-way valve or a 3-way valve in the water circuit, the maximum change-over time of the valve must be 60 seconds.
- **Domestic hot water tank – Capacity.** To avoid stagnation of water, it is important that the storage capacity of the domestic hot water tank meets the daily consumption of domestic hot water.
- **Domestic hot water tank – After installation.** Immediately after installation, the domestic hot water tank must be flushed with fresh water. This procedure must be repeated at least once a day the first 5 consecutive days after installation.
- **Domestic hot water tank – Standstills.** In cases where during longer periods of time there is no consumption of hot water, the equipment MUST be flushed with fresh water before usage.
- **Domestic hot water tank – Disinfection.** For the disinfection function of the domestic hot water tank, see "[10.5.6 Tank](#)" [▶ 142].

- **Thermostatic mixing valves.** In accordance with the applicable legislation, it may be necessary to install thermostatic mixing valves.
- **Hygienic measures.** The installation must be in compliance with the applicable legislation and may require additional hygienic installation measures.
- **Recirculation pump.** In accordance with the applicable legislation, it may be required to connect a recirculation pump in between the hot water end point and the recirculation connection of the domestic hot water tank.

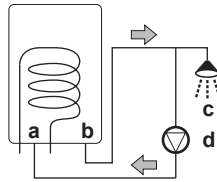

- a** Recirculation connection
- b** Hot water connection
- c** Shower
- d** Recirculation pump

- **Valve towards expansion vessel.** The valve towards the expansion vessel (if equipped) **MUST** be open.

8.1.2 Formula to calculate the expansion vessel pre-pressure

The pre-pressure (P_g) of the vessel depends on the installation height difference (H):

$$P_g = 0.3 + (H/10) \text{ (bar)}$$

8.1.3 To check the water volume and flow rate

The indoor unit has an expansion vessel of 10 litre with a factory-set pre-pressure of 1 bar.

To make sure that the unit operates properly:

- You **MUST** check the minimum and maximum water volume.
- You might need to adjust the pre-pressure of the expansion vessel.

Minimum water volume

Check that the total water volume in the installation is minimum 20 litres, the internal water volume of the outdoor unit **NOT** included.



INFORMATION

In critical processes, or in rooms with a high heat load, extra water might be required.



NOTICE

When circulation in each space heating/cooling loop is controlled by remotely controlled valves, it is important that the minimum water volume is guaranteed, even if all of the valves are closed.

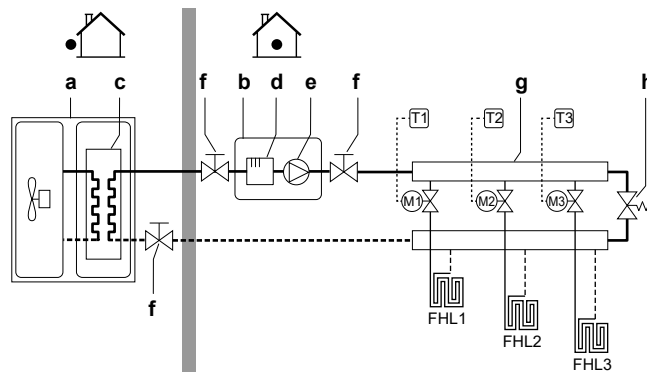

- a** Outdoor unit
- b** Indoor unit
- c** Heat exchanger
- d** Backup heater
- e** Pump
- f** Shut-off valve
- g** Collector (field supply)
- h** Overpressure bypass valve (delivered as accessory)
- FHL1...3** Floor heating loop (field supply)
- T1...3** Individual room thermostat (optional)
- M1...3** Individual motorised valve to control loop FHL1...3 (field supply)

Maximum water volume



NOTICE

The maximum water volume depends on whether glycol is added to the water circuit. For more information on the addition of glycol, refer to "8.2.5 To protect the water circuit against freezing" [▶ 80].

Use the following graph to determine the maximum water volume for the calculated pre-pressure.

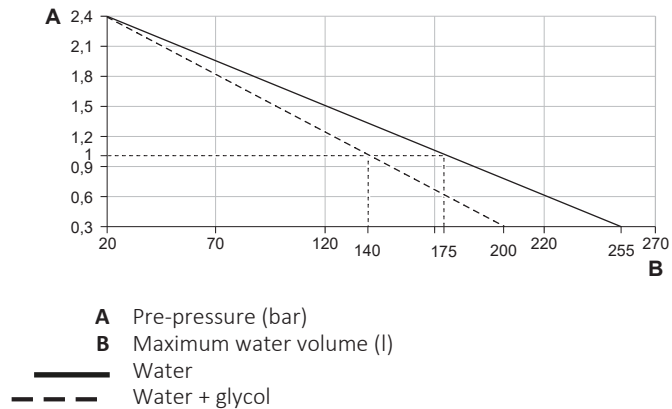

Example: Maximum water volume and expansion vessel pre-pressure

Installation height difference ^(a)	Water volume	
	≤200 l	>200 l
≤7 m	No pre-pressure adjustment is required.	Do the following: <ul style="list-style-type: none"> Decrease the pre-pressure according to the required installation height difference. The pre-pressure should decrease by 0.1 bar for each metre below 7 m. Check if the water volume does NOT exceed the maximum allowed water volume.
>7 m	Do the following: <ul style="list-style-type: none"> Increase the pre-pressure according to the required installation height difference. The pre-pressure should increase by 0.1 bar for each metre above 7 m. Check if the water volume does NOT exceed the maximum allowed water volume. 	The expansion vessel of the indoor unit is too small for the installation. In this case, it is recommended to install an extra vessel outside the unit.

^(a) This is the height difference (m) between the highest point of the water circuit and the indoor unit. If the indoor unit is at the highest point of the installation, the installation height is 0 m.

Minimum flow rate

Check that the minimum flow rate in the installation is guaranteed in all conditions. This minimum flow rate is required during defrost/backup heater operation. For this purpose, use the overpressure bypass valve delivered with the unit, and respect the minimum water volume.

Minimum required flow rate
20 l/min



NOTICE

To guarantee proper operation it is recommended to have a minimum flow of 28 l/min during DHW.



NOTICE

If glycol was added to the water circuit, and the temperature of the water circuit is low, the flow rate will NOT be displayed on the user interface. In this case, the minimum flow rate can be checked by way of the pump test (check that the user interface does NOT display error 7H).

**NOTICE**

When circulation in each or certain space heating loops is controlled by remotely controlled valves, it is important that the minimum flow rate is guaranteed, even if all valves are closed. In case the minimum flow rate cannot be reached, a flow error 7H will be generated (no heating or operation).

See the recommended procedure as described in "11.4 Checklist during commissioning" [▶ 171].

8.1.4 Changing the pre-pressure of the expansion vessel

**NOTICE**

ONLY a licensed installer may adjust the pre-pressure of the expansion vessel.

The default pre-pressure of the expansion vessel is 1 bar. When it is required to change the pre-pressure, take following guidelines into account:

- Only use dry nitrogen to set the expansion vessel pre-pressure.
- Inappropriate setting of the expansion vessel pre-pressure will lead to malfunction of the system.

Changing the pre-pressure of the expansion vessel should be done by releasing or increasing nitrogen pressure through the Schrader valve of the expansion vessel.

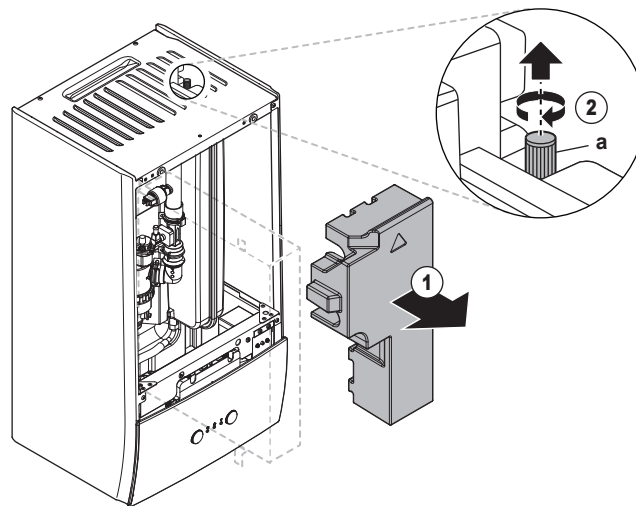

a Schrader valve

8.1.5 To check the water volume: Examples

Example 1

The indoor unit is installed 5 m below the highest point in the water circuit. The total water volume in the water circuit is 100 l.

No actions or adjustments are required.

Example 2

The indoor unit is installed at the highest point in the water circuit. The total water volume in the water circuit is 250 l.

Actions:

- Because the total water volume (250 l) is more than the default water volume (200 l), the pre-pressure must be decreased.

- The required pre-pressure is:
 $P_g = (0.3 + (H/10)) \text{ bar} = (0.3 + (0/10)) \text{ bar} = 0.3 \text{ bar}$
- The corresponding maximum water volume at 0.3 bar is 290 l. (See the graph in "Maximum water volume" [▶ 74]).
- Because 250 l is lower than 290 l, the expansion vessel is appropriate for the installation.

8.2 Connecting water piping

8.2.1 About connecting the water piping

Before connecting the water piping

Make sure the outdoor and indoor unit are mounted.

Typical workflow

Connecting the water piping typically consists of the following stages:

- 1 Connecting the water piping to the outdoor unit.
- 2 Connecting the drain hose to the drain.
- 3 Filling the water circuit.
- 4 Filling the domestic hot water tank.
- 5 Insulating the water piping.

8.2.2 Precautions when connecting the water piping



INFORMATION

Also read the precautions and requirements in the following chapters:

- General safety precautions
- Preparation

8.2.3 To connect the water piping



NOTICE

Do NOT use excessive force when connecting the field piping and make sure the piping is aligned properly. Deformation of the piping can cause malfunctioning of the unit.

Outdoor unit

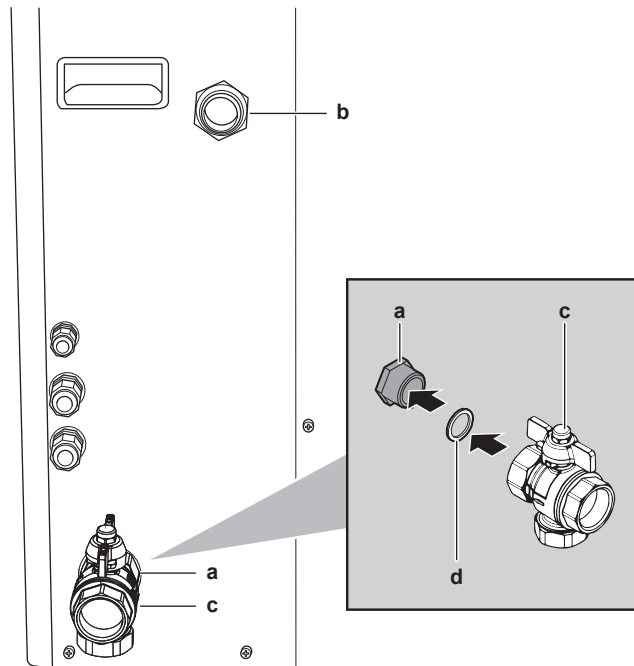

- a Water IN (screw connection, male, 1")
- b Water OUT (screw connection, male, 1")
- c Shut-off valve with integrated filter (delivered as accessory)(2× screw connection, female, 1")
- d O-ring



NOTICE

About the shut-off valve with integrated filter (delivered as accessory):

- The installation of the valve at the water inlet is mandatory.
- Mind the flow direction of the valve.

- 1 Connect the O-rings and shut-off valve to the outdoor unit water inlet.
- 2 Connect the field piping to the shut-off valve.
- 3 Connect the field piping to the outdoor unit water outlet.



NOTICE

Install air purge valves at all local high points.

Indoor unit



NOTICE

Do NOT use excessive force when connecting the piping. Deformation of the piping can cause malfunctioning of the unit.

- 1 Connect the O-rings and shut-off valves to the indoor unit water connections.
- 2 Connect the outdoor unit field piping on the water IN connection (a) of the indoor unit.
- 3 Connect the space heating/cooling field piping on the space heating water OUT connection (b) of the indoor unit.

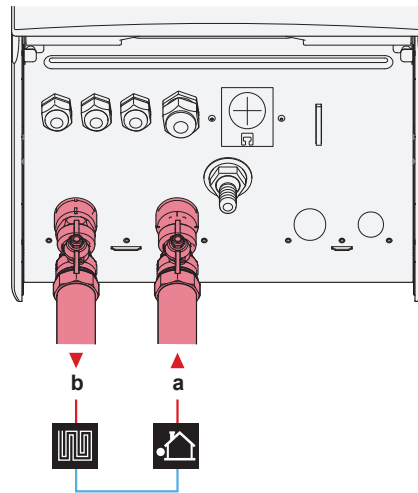

- a Water IN (screw connection, 1")
b Space heating water OUT (screw connection, 1")



NOTICE



Overpressure bypass valve (delivered as accessory). We recommend to install the overpressure bypass valve in the space heating water circuit.

- Mind the minimum water volume when choosing the installation location of the overpressure bypass valve (at the indoor unit, or at the collector). See ["8.1.3 To check the water volume and flow rate"](#) [▶ 73].
- Mind the minimum flow rate when adjusting the overpressure bypass valve setting. See ["8.1.3 To check the water volume and flow rate"](#) [▶ 73] and ["11.4.1 To check the minimum flow rate"](#) [▶ 171].



NOTICE

Install air purge valves at all local high points.



NOTICE

In case an optional domestic hot water tank is installed: A pressure relief valve (field supply) with an opening pressure of maximum 10 bar (= 1 MPa) must be installed on the domestic cold water inlet connection in accordance with the applicable legislation.

8.2.4 To fill the water circuit

To fill the water circuit, use a field supply filling kit. Make sure you comply with the applicable legislation.



NOTICE

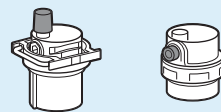

Make sure both air purge valves (one on the magnetic filter and one on the backup heater) are open.

All automatic air purge valves **MUST** remain open after commissioning.

8.2.5 To protect the water circuit against freezing

About freeze protection

Frost can damage the system. To prevent the hydraulic components from freezing, the software is equipped with special frost protection functions, that include the activation of pump in case of low temperatures:

- Water pipe freeze prevention (see "[Water pipe freeze prevention](#)" [▶ 156]),
- Drain prevention. Only applicable when **Bivalent** is enabled ([C-02]=1). This function prevents the opening of freeze protection valves in the water piping to the outdoor unit when the auxiliary boiler is running at negative outdoor temperatures.

However, in case of a power failure, these functions cannot guarantee protection.

Do one of the following to protect the water circuit against freezing:

- Add glycol to the water. Glycol lowers the freezing point of the water.
- Install freeze protection valves. Freeze protection valves drain the water from the system before it can freeze. Insulate the freeze protection valves in a similar way as the water piping, but do NOT insulate the inlet and outlet (release) of these valves.

**NOTICE**

If you add glycol to the water, do NOT install freeze protection valves. **Possible consequence:** Glycol leaking out of the freeze protection valves.

Freeze protection by glycol**About freeze protection by glycol**

Adding glycol to the water lowers the freezing point of water.

**WARNING**

Ethylene glycol is toxic.

**WARNING**

Due to the presence of glycol, corrosion of the system is possible. Uninhibited glycol will turn acidic under the influence of oxygen. This process is accelerated by the presence of copper and high temperatures. The acidic uninhibited glycol attacks metal surfaces and forms galvanic corrosion cells that cause severe damage to the system. Therefore it is important that:

- the water treatment is correctly executed by a qualified water specialist,
- a glycol with corrosion inhibitors is selected to counteract acids formed by the oxidation of glycols,
- no automotive glycol is used because their corrosion inhibitors have a limited lifetime and contain silicates which can foul or plug the system,
- galvanized pipes are NOT used in glycol systems since the presence may lead to the precipitation of certain components in the glycol's corrosion inhibitor.

**NOTICE**

Glycol absorbs water from its environment. Therefore do NOT add glycol that has been exposed to air. Leaving the cap off the glycol container causes the concentration of water to increase. The glycol concentration is then lower than assumed. As a result, the hydraulic components might freeze up after all. Take preventive actions to ensure a minimal exposure of the glycol to air.

Types of glycol

The types of glycol that can be used depend on whether the system contains a domestic hot water tank:

If...	Then...
The system contains a domestic hot water tank	Only use propylene glycol ^(a)
The system does NOT contain a domestic hot water tank	You can use either propylene glycol ^(a) or ethylene glycol

^(a) Propylene glycol, including the necessary inhibitors, classified as Category III according to EN1717.

Required concentration of glycol

The required concentration of glycol depends on the lowest expected outdoor temperature, and on whether you want to protect the system from bursting or from freezing. To prevent the system from freezing, more glycol is required.

Add glycol according to the table below.

Lowest expected outdoor temperature	Prevent from bursting	Prevent from freezing
-5°C	10%	15%
-10°C	15%	25%
-15°C	20%	35%
-20°C	25%	—
-25°C	30%	—
-30°C	35%	—



INFORMATION

- Protection against bursting: the glycol will prevent the piping from bursting, but NOT the liquid inside the piping from freezing.
- Protection against freezing: the glycol will prevent the liquid inside the piping from freezing.



NOTICE

- The required concentration might differ depending on the type of glycol. ALWAYS compare the requirements from the table above with the specifications provided by the glycol manufacturer. If necessary, meet the requirements set by the glycol manufacturer.
- The added concentration of glycol should NEVER exceed 35%.
- If the liquid in the system is frozen, the pump will NOT be able to start. Mind that if you only prevent the system from bursting, the liquid inside might still freeze.
- When water is at standstill inside the system, the system is very likely to freeze and get damaged.

Glycol and the maximum allowed water volume

Adding glycol to the water circuit reduces the maximum allowed water volume of the system. For more information, see "[Maximum water volume](#)" [▶ 74].

Glycol setting



NOTICE

If glycol is present in the system, setting [E-OD] must be set to 1. If the glycol setting is NOT set correctly, the liquid inside the piping can freeze.

Freeze protection by freeze protection valves

About freeze protection valves

It is the responsibility of the installer to protect the field piping against freezing. When no glycol is added to the water, you can use freeze protection valves at all lowest points of the field piping to drain the water from the system before it can freeze.

To install freeze protection valves

To protect the field piping against freezing, install the following parts:

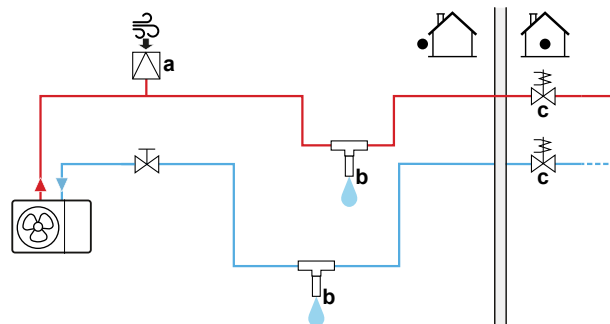

- a Automatic air intake
- b Freeze protection valve (optional – field supply)
- c Normally closed valves (recommended – field supply)

Part	Description
	An automatic air intake (for air supply) should be installed at the highest point. For example, an automatic air purge.
	Protection for the field piping. The freeze protection valves must be installed: <ul style="list-style-type: none"> ▪ vertically to allow water to flow out properly and free from obstructions. ▪ at all lowest points of the field piping. ▪ in the coldest part and away from heat sources. <p>Note: Leave at least 15 cm clearance from the ground to prevent ice from blocking the water exit.</p>
	Isolation of water inside the house when there is a power interruption. Normally closed valves (located indoors near the piping entry/exit points) can prevent that all water from indoor piping is drained when the freeze protection valves open. <ul style="list-style-type: none"> ▪ When there is a power interruption: The normally closed valves close and isolate the water inside the house. If the freeze protection valves open, only the water outside the house is drained. ▪ In other circumstances (example: when there is a pump failure): The normally closed valves remain open. If the freeze protection valves open, the water from inside the house is also drained.

**NOTICE**

When freeze protection valves are installed, set the minimum cooling setpoint (default=8°C) at least 2°C higher than the maximum opening temperature of the freeze protection valve. If lower, freeze protection valves can open during cooling operation.

8.2.6 To fill the domestic hot water tank

See the installation manual of the domestic hot water tank.

8.2.7 To insulate the water piping

The piping in the complete water circuit **MUST** be insulated to prevent condensation during cooling operation and reduction of the heating and cooling capacity.

Outdoor water piping insulation**NOTICE**

Outside piping. Make sure the outside piping is insulated as instructed to protect against hazards.

For piping in free air, it is recommended to use the insulation thickness as shown in below table as a minimum (with $\lambda=0.039$ W/mK).

Piping length (m)	Minimum insulation thickness (mm)
<20	19
20~30	32
30~40	40
40~50	50

For other cases the minimum insulation thickness can be determined using the Hydronic Piping Calculation tool.

The Hydronic Piping Calculation tool also calculates the maximum hydronic piping length from the indoor unit to the outdoor unit based on the emitter pressure drop or the other way around.

The Hydronic Piping Calculation tool is part of the Heating Solutions Navigator which can be reached via <https://professional.standbyme.daikin.eu>.

Please contact your dealer if you have no access to Heating Solutions Navigator.

This recommendation ensures good operation of the unit, however, local regulations may differ and shall be followed.

9 Electrical installation

In this chapter

9.1	About connecting the electrical wiring	84
9.1.1	Precautions when connecting the electrical wiring	84
9.1.2	Guidelines when connecting the electrical wiring	85
9.1.3	About electrical compliance	86
9.1.4	About preferential kWh rate power supply.....	86
9.1.5	Overview of electrical connections except external actuators.....	87
9.2	Connections to the outdoor unit.....	87
9.2.1	To connect the electrical wiring to the outdoor unit	87
9.3	Connections to the indoor unit.....	89
9.3.1	To connect the main power supply	89
9.3.2	To connect the backup heater power supply.....	90
9.3.3	To connect the shut-off valve	92
9.3.4	To connect the electricity meters.....	93
9.3.5	To connect the domestic hot water pump.....	93
9.3.6	To connect the alarm output.....	94
9.3.7	To connect the space cooling/heating ON/OFF output	94
9.3.8	To connect the changeover to external heat source	95
9.3.9	To connect the power consumption digital inputs	95
9.3.10	To connect the safety thermostat (normally closed contact).....	96
9.3.11	To connect a Smart Grid	96

9.1 About connecting the electrical wiring

Before connecting the electrical wiring

Make sure the water piping is connected.

Typical workflow

Connecting the electrical wiring typically consists of the following stages:

- 1 Making sure the power supply system complies with the electrical specifications of the heat pump.
- 2 Connecting the electrical wiring to the outdoor unit.
- 3 Connecting the electrical wiring to the indoor unit.
- 4 Connecting the main power supply.
- 5 Connecting the backup heater power supply.
- 6 Connecting the shut-off valves.
- 7 Connecting the electrical meters.
- 8 Connecting the domestic hot water pump.
- 9 Connecting the alarm output.
- 10 Connecting the space cooling/heating ON/OFF output.
- 11 Connecting the changeover to an external heat source.
- 12 Connecting the power consumption digital inputs.
- 13 Connecting the safety thermostat.

9.1.1 Precautions when connecting the electrical wiring



INFORMATION

Also read the precautions and requirements in the following chapters:

- General safety precautions
- Preparation

 **DANGER: RISK OF ELECTROCUTION**

 **WARNING**
ALWAYS use multicore cable for power supply cables.

9.1.2 Guidelines when connecting the electrical wiring

Keep the following in mind:

- If stranded conductor wires are used, install a round crimp-style terminal on the end of the wire. Place the round crimp-style terminal on the wire up to the covered part and fasten the terminal with the appropriate tool.

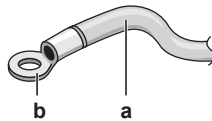

- a** Stranded conductor wire
- b** Round crimp-style terminal

- Use the following methods for installing wires:

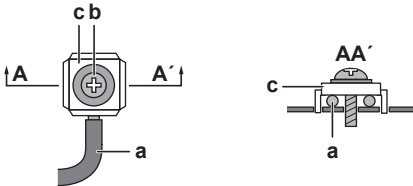
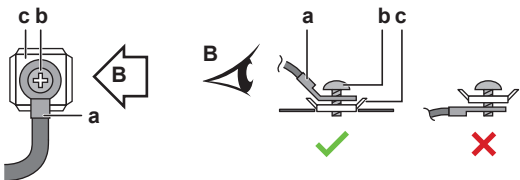
Wire type	Installation method
Single-core wire	 <p>a Curled single-core wire b Screw c Flat washer</p>
Stranded conductor wire with round crimp-style terminal	 <p>a Terminal b Screw c Flat washer ✓ Allowed ✗ NOT allowed</p>

Tightening torques

Outdoor unit:

Item	Tightening torque (N•m)
M4 (X1M)	1.2~1.5
M4 (earth)	

Indoor unit:

Item	Tightening torque (N•m)
X1M	2.45 ±10%
X2M	0.88 ±10%
X5M	0.88 ±10%
X6M	2.45 ±10%
X7M, X8M	2.45 ±10%
X10M	0.88 ±10%
M4 (earth)	1.47 ±10%

9.1.3 About electrical compliance

Only for the backup heater of the indoor unit

See "9.3.2 To connect the backup heater power supply" [▶ 90].

9.1.4 About preferential kWh rate power supply

Electricity companies throughout the world work hard to provide reliable electric service at competitive prices and are often authorised to bill clients at benefit rates. E.g. time-of-use rates, seasonal rates, Wärmepumpentarif in Germany and Austria, ...

This equipment allows for connection to such preferential kWh rate power supply delivery systems.

Consult with the electricity company acting as provider at the site where this equipment is to be installed to know whether it is appropriate to connect the equipment in one of the preferential kWh rate power supply delivery systems available, if any.

When the equipment is connected to such preferential kWh rate power supply, the electricity company is allowed to:

- interrupt power supply to the equipment for certain periods of time;
- demand that the equipment ONLY consumes a limited amount of electricity during certain periods of time.

The indoor unit is designed to receive an input signal by which the unit switches into forced OFF mode. At that moment, the outdoor unit compressor will NOT operate.

The wiring to the unit is different depending on whether the power supply is interrupted or NOT.

9.1.5 Overview of electrical connections except external actuators

Normal power supply	Preferential kWh rate power supply	
	Power supply is NOT interrupted	Power supply is interrupted
	<p>During preferential kWh rate power supply activation, power supply is NOT interrupted. The outdoor unit is turned off by the control.</p> <p>Remark: The electricity company must always allow the power consumption of the indoor unit.</p>	<p>During preferential kWh rate power supply activation, power supply is interrupted immediately or after some time by the electricity company. In this case, the indoor unit must be powered by a separate normal power supply.</p>

- a Normal power supply
- b Preferential kWh rate power supply
- 1 Power supply for outdoor unit
- 2 Power supply and interconnection cable to indoor unit
- 3 Power supply for backup heater
- 4 Preferential kWh rate power supply (voltage free contact)
- 5 Normal kWh rate power supply (to power the indoor unit PCB in the event of power supply interruption of the preferential kWh rate power supply)

9.2 Connections to the outdoor unit

9.2.1 To connect the electrical wiring to the outdoor unit

- 1 Remove the switch box cover. See "[7.2.2 To open the outdoor unit](#)" [▶ 62].
- 2 Strip insulation (20 mm) from the wires.

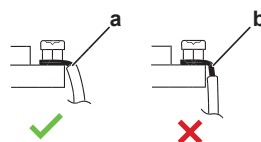

a Strip wire end to this point

b An excessive strip length may cause electrical shock or leakage

3 Insert the wiring at the back of the unit:

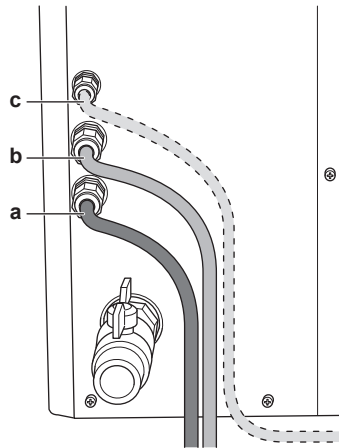

- a** Power supply cable (high voltage)
- b** Communication cable (high voltage)
- c** Cable for bottom plate heater (optional)

4 Inside the unit, route the wiring as follows:

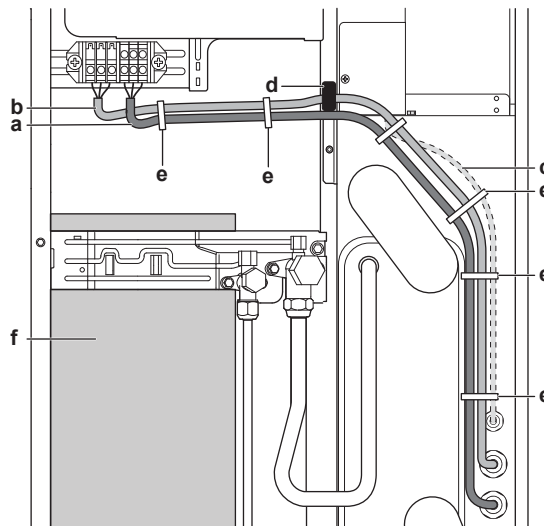

- a** Power supply cable
- b** Communication cable
- c** Cable for bottom plate heater (optional)
- d** Ferrite core
- e** Tie strap
- f** Compressor



NOTICE

To guarantee electromagnetic compatibility:

- Make sure both power supply and communication cables run parallel to one another. Use tie straps to hold the cables together.
- Make sure the cables are located as far away from the compressor as possible.
- The communication cable **MUST** pass through the ferrite core.

5 Make sure that the cable does NOT come in contact with sharp edges or hot gas piping.

6 Install the switch box cover.



INFORMATION

When installing field supply or option cables, foresee sufficient cable length. This will make it possible to remove/reposition the switch box and gain access to other components during service.



CAUTION

Do NOT push or place redundant cable length in the unit.

9.3 Connections to the indoor unit

9.3.1 To connect the main power supply

- 1 Connect the main power supply.

In case of normal kWh rate power supply

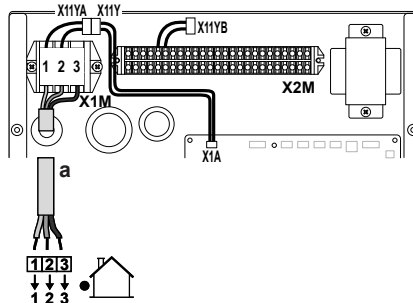

a Interconnection cable (=main power supply)

In case of preferential kWh rate power supply

Connect X11Y to X11YB.

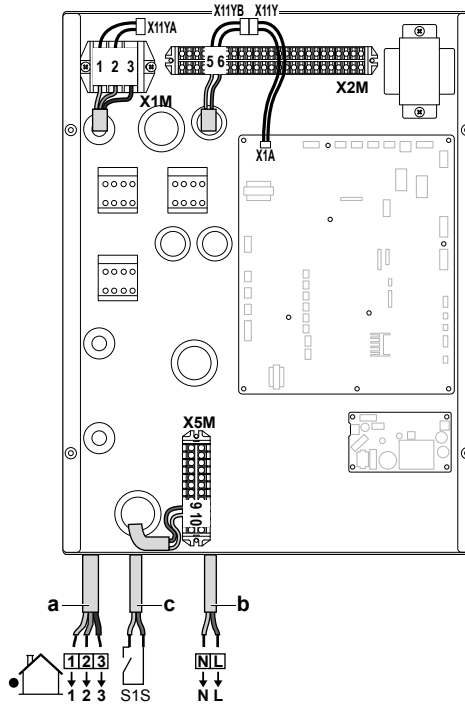

a Interconnection cable (=main power supply)
b Normal kWh rate power supply
c Preferential power supply contact

2 Fix the cables with cable ties to the cable tie mountings.



INFORMATION

In case of preferential kWh rate power supply, connect X11Y to X11YB. The necessity of separate normal kWh rate power supply to indoor unit (b) X2M/5+6 depends on the type of preferential kWh rate power supply.

Separate connection to the indoor unit is required:

- if preferential kWh rate power supply is interrupted when active, OR
- if no power consumption of the indoor unit is allowed at the preferential kWh rate power supply when active.



INFORMATION

The preferential kWh rate power supply contact is connected to the same terminals (X5M/9+10) as the safety thermostat. Thus, the system can have EITHER preferential kWh rate power supply OR a safety thermostat.

9.3.2 To connect the backup heater power supply



WARNING

The backup heater **MUST** have a dedicated power supply and **MUST** be protected by the safety devices required by the applicable legislation.



CAUTION

If the indoor unit has a tank with a built-in electrical booster heater, use a dedicated power circuit for the backup heater and booster heater. **NEVER** use a power circuit shared by another appliance. This power circuit **MUST** be protected with the required safety devices according to the applicable legislation.



CAUTION

To guarantee the unit is completely earthed, **ALWAYS** connect the backup heater power supply and the earth cable.

The backup heater capacity can vary, depending on the indoor unit model. Make sure that the power supply is in accordance with the backup heater capacity, as listed in the table below.

Backup heater type	Backup heater capacity	Power supply	Maximum running current	Z _{max}
*6V	2 kW	1N~ 230 V ^(a)	9 A	—
	4 kW	1N~ 230 V ^(a)	17 A ^{(b)(c)}	0.22 Ω
	6 kW	1N~ 230 V ^(a)	26 A ^{(b)(c)}	0.22 Ω
	2 kW	3~ 230 V ^(d)	5 A	—
	4 kW	3~ 230 V ^(d)	10 A	—
	6 kW	3~ 230 V ^(d)	15 A	—
*9W	3 kW	3N~ 400 V	4 A	—
	6 kW	3N~ 400 V	9 A	—
	9 kW	3N~ 400 V	13 A	—

^(a) 6V3

- (b) Electrical equipment complying with EN/IEC 61000-3-12 (European/International Technical Standard setting the limits for harmonic currents produced by equipment connected to public low-voltage systems with input current >16 A and ≤75 A per phase).
- (c) This equipment complies with EN/IEC 61000-3-11 (European/International Technical Standard setting the limits for voltage changes, voltage fluctuations and flicker in public low-voltage supply systems for equipment with rated current ≤75 A) provided that the system impedance Z_{sys} is less than or equal to Z_{max} at the interface point between the user's supply and the public system. It is the responsibility of the installer or user of the equipment to ensure, by consultation with the distribution network operator if necessary, that the equipment is connected only to a supply with a system impedance Z_{sys} less than or equal to Z_{max} .
- (d) 6T1

Connect the backup heater power supply as follows:

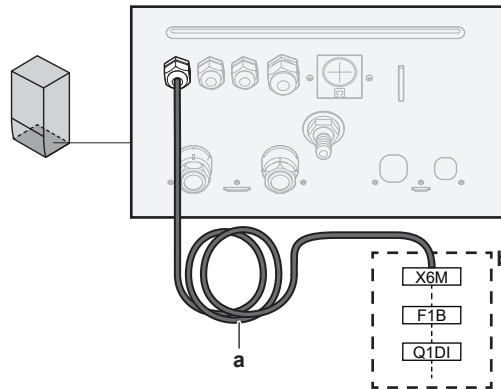

- a Factory-mounted cable connected to the contactor of the backup heater, inside the switch box (K5M)
- b Field wiring (see table below)

Model (power supply)	Connections to backup heater power supply
*6V (6V3: 1N~ 230 V)	

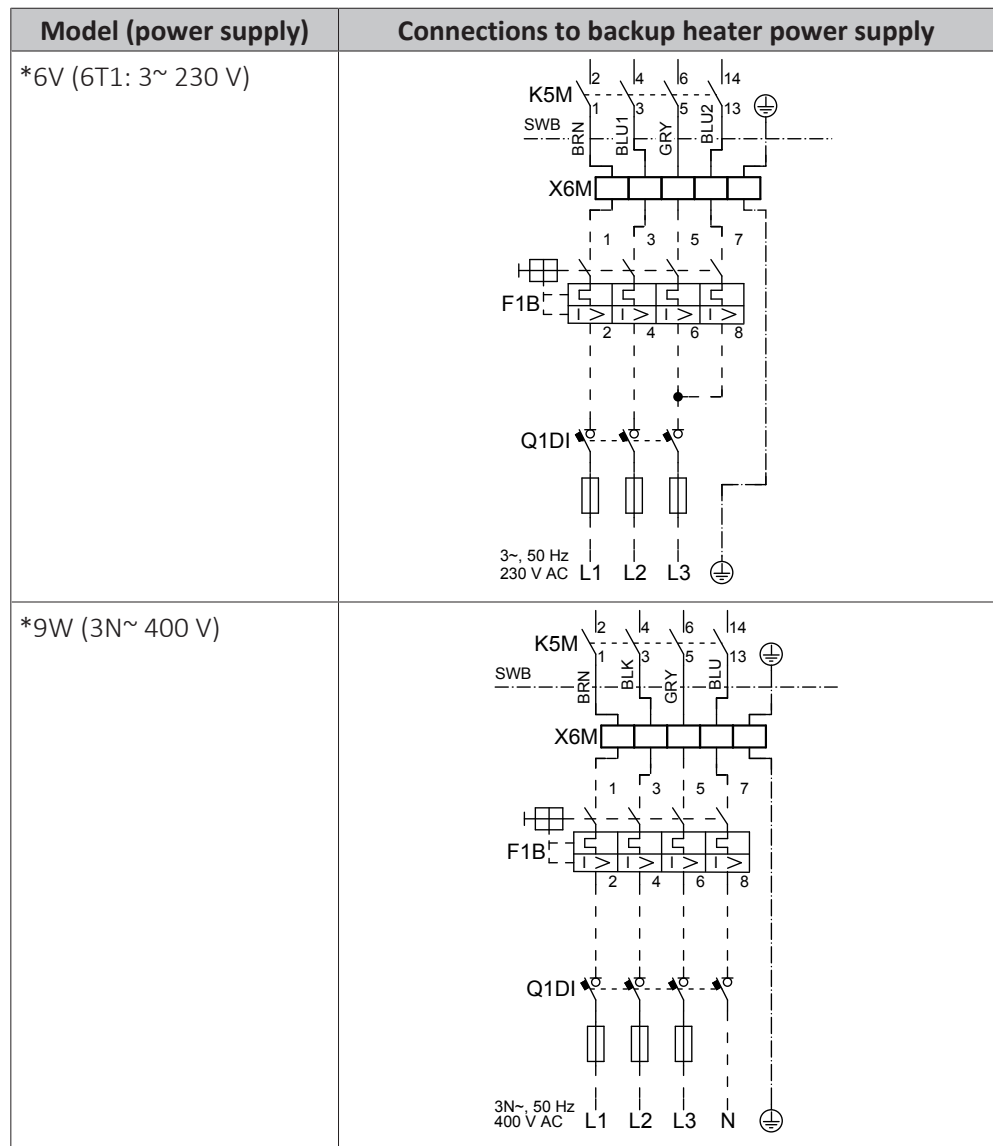

- F1B** Overcurrent fuse (field supply). Recommended fuse: 4-pole; 20 A; curve 400 V; tripping class C.
- K5M** Safety contactor (in the switch box)
- Q1DI** Earth leakage circuit breaker (field supply)
- SWB** Switch box
- X6M** Terminal (field supply)



NOTICE

Do NOT cut or remove the backup heater power supply cable.

9.3.3 To connect the shut-off valve



INFORMATION

Shut-off valve usage example. In case of one LWT zone, and a combination of underfloor heating and heat pump convectors, install a shut-off valve before the underfloor heating to prevent condensation on the floor during cooling operation. For more information, see the installer reference guide.

- 1** Connect the valve control cable to the appropriate terminals as shown in the illustration below.

**NOTICE**

Wiring is different for a NC (normally closed) valve and a NO (normally open) valve.

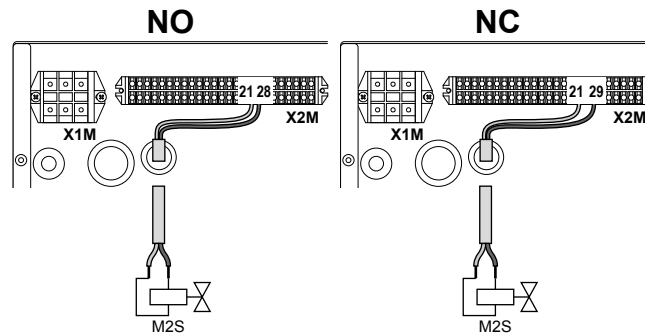

- Fix the cable with cable ties to the cable tie mountings.

9.3.4 To connect the electricity meters

**INFORMATION**

In case of an electricity meter with transistor output, check the polarity. The positive polarity **MUST** be connected to X5M/6 and X5M/4; the negative polarity to X5M/5 and X5M/3.

- Connect the electricity meters cable to the appropriate terminals as shown in the illustration below.

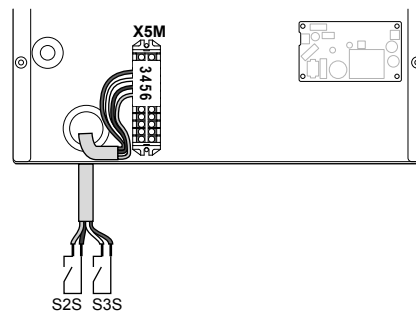

- Fix the cable with cable ties to the cable tie mountings.

9.3.5 To connect the domestic hot water pump

- Connect the domestic hot water pump cable to the appropriate terminals as shown in the illustration below.

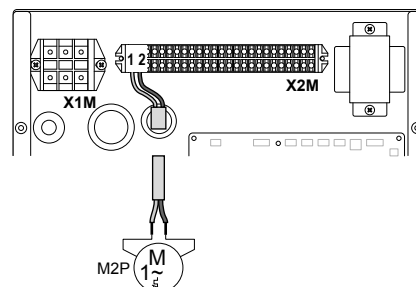

- Fix the cable with cable ties to the cable tie mountings.

9.3.6 To connect the alarm output

- 1 Connect the alarm output cable to the appropriate terminals as shown in the illustration below.

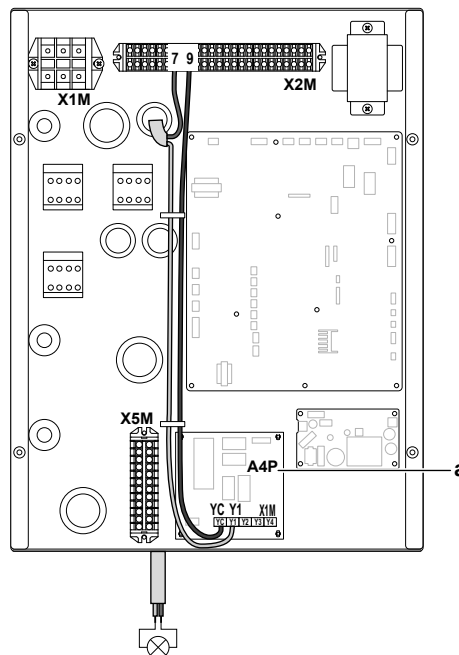

a Installation of EKR P1HBAA is required.

- 2 Fix the cable with cable ties to the cable tie mountings.

9.3.7 To connect the space cooling/heating ON/OFF output



INFORMATION

Cooling is only applicable in case of reversible models.



INFORMATION

Cooling is only applicable in case of:

- Reversible models
- Heating only models + conversion kit (EKHBCONV*)

- 1 Connect the space cooling/heating ON/OFF output cable to the appropriate terminals as shown in the illustration below.

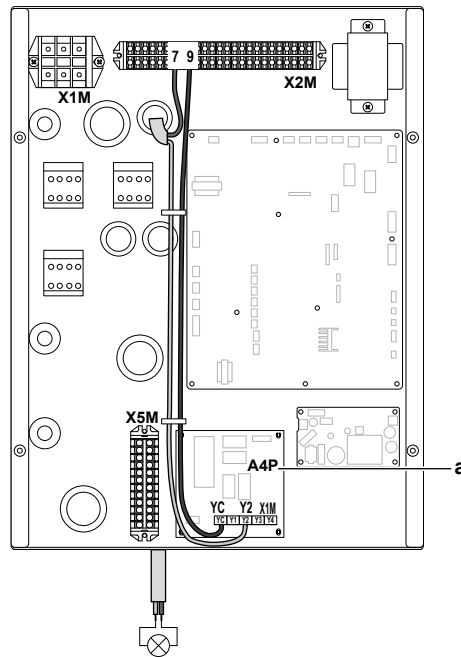

a Installation of EKR1HBAA is required.

- Fix the cable with cable ties to the cable tie mountings.

9.3.8 To connect the changeover to external heat source

- Connect the changeover to external heat source cable to the appropriate terminals as shown in the illustration below.

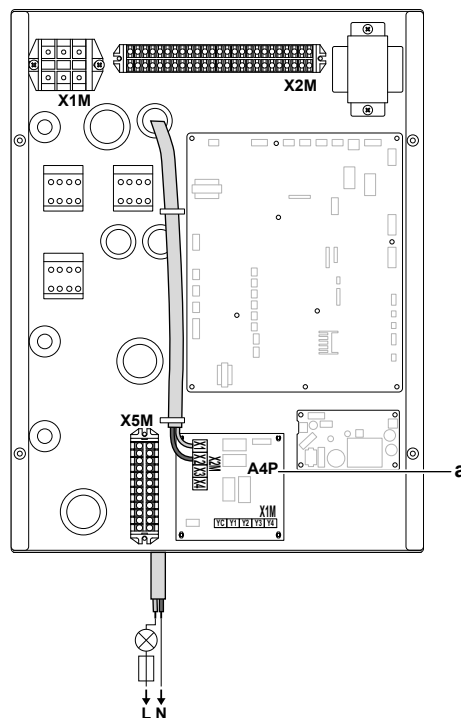

a Installation of EKR1HBAA is required.

- Fix the cable with cable ties to the cable tie mountings.

9.3.9 To connect the power consumption digital inputs

- Connect the power consumption digital inputs cable to the appropriate terminals as shown in the illustration below.

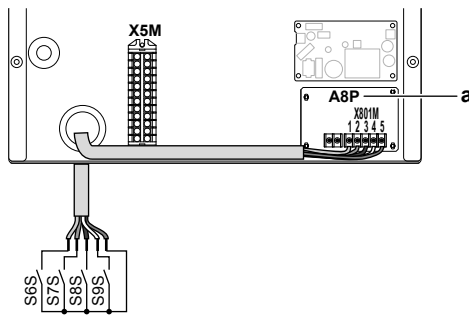

a Installation of EKR1AHTA is required.

- 2 Fix the cable with cable ties to the cable tie mountings.

9.3.10 To connect the safety thermostat (normally closed contact)

- 1 Connect the safety thermostat (normally closed) cable to the appropriate terminals as shown in the illustration below.

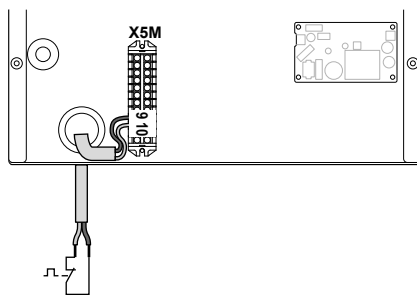

- 2 Fix the cable with cable ties to the cable tie mountings.



NOTICE

Make sure to select and install the safety thermostat according to the applicable legislation.

In any case, to prevent unnecessary tripping of the safety thermostat, we recommend the following:

- The safety thermostat is automatically resettable.
- The safety thermostat has a maximum temperature variation rate of 2°C/min.
- There is a minimum distance of 2 m between the safety thermostat and the motorized 3-way valve delivered with the domestic hot water tank.



INFORMATION

ALWAYS configure the safety thermostat after it is installed. Without configuration, the unit will ignore the safety thermostat contact.



INFORMATION

The preferential kWh rate power supply contact is connected to the same terminals (X5M/9+10) as the safety thermostat. Thus, the system can have EITHER preferential kWh rate power supply OR a safety thermostat.

9.3.11 To connect a Smart Grid

This topic describes 2 possible ways to connect the indoor unit to a Smart Grid:

- In case of low voltage Smart Grid contacts
- In case of high voltage Smart Grid contacts. This requires the installation of the Smart Grid relay kit (EKRELSG).

The 2 incoming Smart Grid contacts can activate the following Smart Grid modes:

Smart Grid contact		Smart Grid operation mode
①	②	
0	0	Free running
0	1	Forced off
1	0	Recommended on
1	1	Forced on

The use of a Smart Grid pulse meter is not mandatory:

If Smart Grid pulse meter is...	Then [9.8.8] Limit setting kW is...
Used ([9.A.2] Electricity meter 2 ≠ None)	Not applicable
Not used ([9.A.2] Electricity meter 2 = None)	Applicable

In case of low voltage Smart Grid contacts

The wiring of the Smart Grid in case of low voltage contacts is as follows:

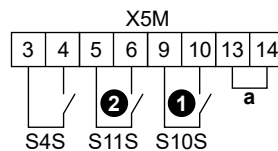

a Jumper (factory-mounted). If you also connect a safety thermostat (Q4L), replace the jumper with the safety thermostat wires.

- S4S** Smart Grid pulse meter
- ①/S10S** Low voltage Smart Grid contact 1
- ②/S11S** Low voltage Smart Grid contact 2

- 1 Connect the wiring as follows:
- 2 Fix the cables with cable ties to the cable tie mountings.

In case of high voltage Smart Grid contacts

The wiring of the Smart Grid in case of high voltage contacts is as follows:

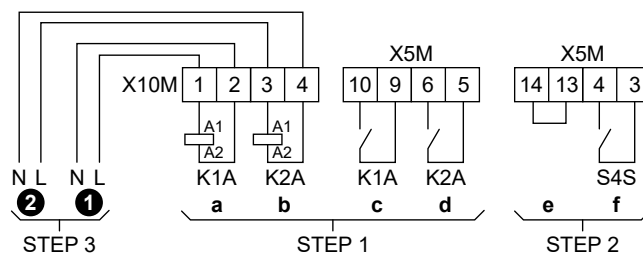

- STEP 1** Smart Grid relay kit installation
- STEP 2** Low voltage connections
- STEP 3** High voltage connections
 - ①** High voltage Smart Grid contact 1
 - ②** High voltage Smart Grid contact 2
 - a, b** Coil sides of relays
 - c, d** Contact sides of relays
 - e** Jumper (factory-mounted). If you also connect a safety thermostat (Q4L), replace the jumper with the safety thermostat wires.
 - f** Smart Grid pulse meter

- 1 Install the components of the Smart Grid relay kit as follows:

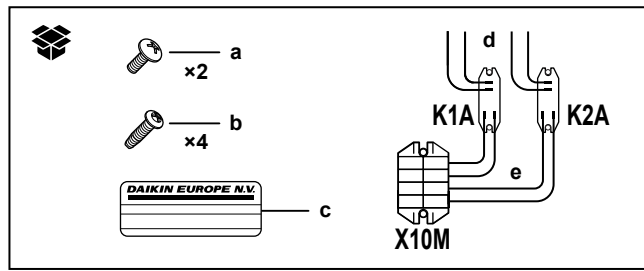

K1A, K2A Relays

X10M Terminal block

a Screws for X10M

b Screws for K1A and K2A

c Sticker to put on the high voltage wires

d Wires between the relays and X5M (AWG22 ORG)

e Wires between the relays and X10M (AWG18 RED)

- 2 Connect the low voltage wiring as follows:
- 3 Connect the high voltage wiring as follows:
- 4 Fix the cables with cable ties to the cable tie mountings. If necessary, bundle excessive cable length with a cable tie.

10 Configuration



INFORMATION

Cooling is only applicable in case of reversible models.

In this chapter

10.1	Overview: Configuration.....	99
10.1.1	To access the most used commands	100
10.2	Configuration wizard	102
10.3	Possible screens.....	103
10.3.1	Possible screens: Overview	103
10.3.2	Home screen	104
10.3.3	Main menu screen	106
10.3.4	Menu screen.....	107
10.3.5	Setpoint screen	107
10.3.6	Detailed screen with values	108
10.3.7	Schedule screen: Example	108
10.4	Weather-dependent curve.....	113
10.4.1	What is a weather-dependent curve?.....	113
10.4.2	2-points curve.....	113
10.4.3	Slope-offset curve	114
10.4.4	Using weather-dependent curves	116
10.5	Settings menu	118
10.5.1	Malfunctioning	118
10.5.2	Room	118
10.5.3	Main zone.....	121
10.5.4	Additional zone	130
10.5.5	Space heating/cooling.....	134
10.5.6	Tank	142
10.5.7	User settings.....	143
10.5.8	Information.....	147
10.5.9	Installer settings	148
10.5.10	Commissioning	166
10.5.11	User profile.....	166
10.5.12	Operation	166
10.6	Menu structure: Overview user settings.....	167
10.7	Menu structure: Overview installer settings.....	168

10.1 Overview: Configuration

This chapter describes what you have to do and know to configure the system after it is installed.

Why

If you do NOT configure the system correctly, it might NOT work as expected. The configuration influences the following:

- The calculations of the software
- What you can see on and do with the user interface

How

You can configure the system via the user interface.

- **First time – Configuration wizard.** When you turn ON the user interface for the first time (via the unit), the configuration wizard starts to help you configure the system.

- **Restart the configuration wizard.** If the system is already configured, you can restart the configuration wizard. To restart the configuration wizard, go to **Installer settings > Configuration wizard**. To access **Installer settings**, see "10.1.1 To access the most used commands" [▶ 100].
- **Afterwards.** If necessary, you can make changes to the configuration in the menu structure or the overview settings.

i

INFORMATION

When the configuration wizard is finished, the user interface will show an overview screen and request to confirm. When confirmed, the system will restart and the home screen will be displayed.

Accessing settings – Legend for tables

You can access the installer settings using two different methods. However, NOT all settings are accessible via both methods. If so, the corresponding table columns in this chapter are set to N/A (not applicable).

Method	Column in tables
Accessing settings via the breadcrumb in the home menu screen or the menu structure . To enable breadcrumbs, press the ? button in the home screen.	# For example: [2.9]
Accessing settings via the code in the overview field settings .	Code For example: [C-07]





See also:

- "To access the installer settings" [▶ 101]
- "10.7 Menu structure: Overview installer settings" [▶ 168]

10.1.1 To access the most used commands

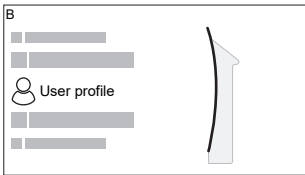
To change the user permission level

You can change the user permission level as follows:

1	Go to [B]: User profile . 	
2	Enter the applicable pin code for the user permission level. <ul style="list-style-type: none"> ▪ Browse through the list of digits and change the selected digit. ▪ Move the cursor from left to right. ▪ Confirm the pin code and proceed. 	—   

Installer pin code

The **Installer** pin code is **5678**. Additional menu items and installer settings are now available.

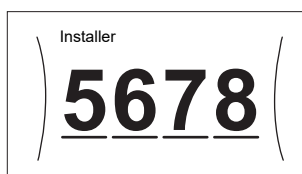

Advanced user pin code

The **Advanced user** pin code is **1234**. Additional menu items for the user are now visible.

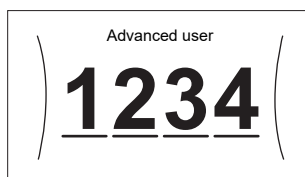

User pin code

The **User** pin code is **0000**.

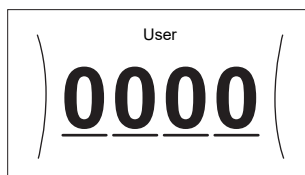

To access the installer settings



- 1 Set the user permission level to **Installer**.
- 2 Go to [9]: **Installer settings**.

To modify an overview setting

Example: Modify [1-01] from 15 to 20.

Most settings can be configured via the menu structure. If for any reason it is required to change a setting using the overview settings, then the overview settings can be accessed as follows:

1	Set the user permission level to Installer . See " To change the user permission level " [▶ 100].	—
2	Go to [9.]: Installer settings > Overview field settings .	
3	Turn the left dial to select the first part of the setting and confirm by pressing the dial.	
4	Turn the left dial to select the second part of the setting	
5	Turn the right dial to modify the value from 15 to 20.	

6	Press the left dial to confirm the new setting.	
7	Press the center button to go back to the home screen.	

**INFORMATION**

When you change the overview settings and you go back to the home screen, the user interface will show a popup screen and request to restart the system.

When confirmed, the system will restart and recent changes will be applied.

10.2 Configuration wizard

After first power ON of the system, the user interface will guide you using the configuration wizard. This way you can set the most important initial settings. This way the unit will be able to run properly. Afterwards, more detailed settings can be done via the menu structure if required.

You can find a short overview of the settings in the configuration here. All the settings can also be adjusted in the settings menu (use the breadcrumbs).

For the setting...		Refer to...
Language [7.1]		
Time/date [7.2]		
	Hours	—
	Minutes	
	Year	
	Month	
	Day	
System		
	Indoor unit type (read only)	"10.5.9 Installer settings" [▶ 148]
	Backup heater type [9.3.1]	
	Domestic hot water [9.2.1]	
	Emergency [9.5.1]	
	Number of zones [4.4]	"10.5.5 Space heating/cooling" [▶ 134]
Backup heater		
	Voltage [9.3.2]	"Backup heater" [▶ 150]
	Configuration [9.3.3]	
	Capacity step 1 [9.3.4]	
	Additional capacity step 2 [9.3.5] (if applicable)	
Main zone		

For the setting...		Refer to...
Emitter type [2.7]		"10.5.3 Main zone" [▶ 121]
Control [2.9]		
Setpoint mode [2.4]		
Heating WD curve [2.5] (if applicable)		
Cooling WD curve [2.6] (if applicable)		
Schedule [2.1]		
Additional zone (only if [4.4]=1)		
Emitter type [3.7]		"10.5.4 Additional zone" [▶ 130]
Control (read only) [3.9]		
Setpoint mode [3.4]		
Heating WD curve [3.5] (if applicable)		
Cooling WD curve [3.6] (if applicable)		
Schedule [3.1]		
Tank		
Heat up mode [5.6]		"10.5.6 Tank" [▶ 142]
Comfort setpoint [5.2]		
Eco setpoint [5.3]		
Reheat setpoint [5.4]		

10.3 Possible screens

10.3.1 Possible screens: Overview

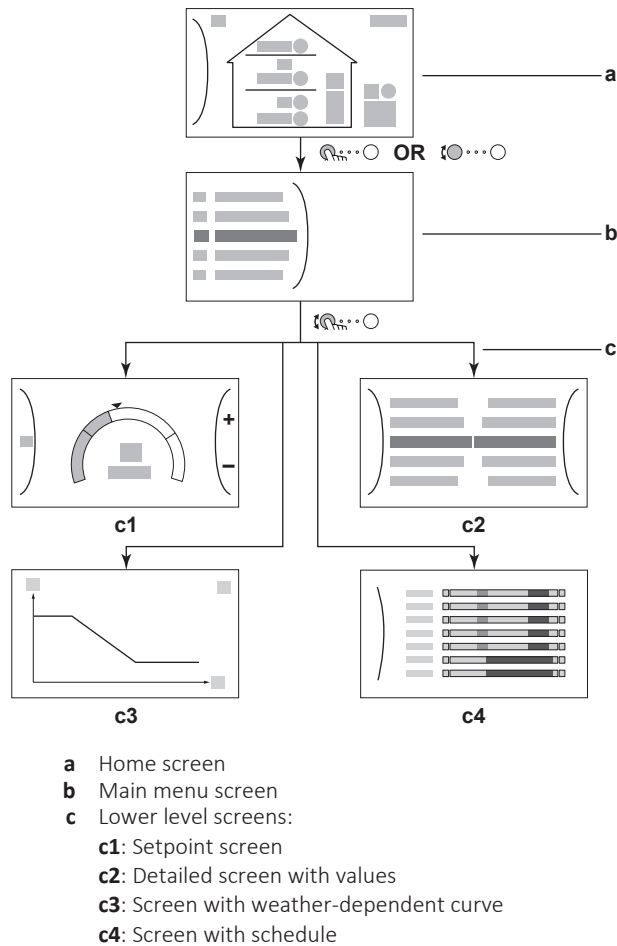

The most common screens are as follows:





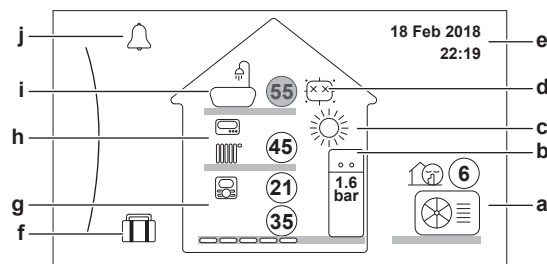

















10.3.2 Home screen



Press the  button to go back to the home screen. You see an overview of the unit configuration and the room and setpoint temperatures. Only symbols applicable for your configuration are visible on the home screen.





Possible actions on this screen	
	Go through the list of the main menu.
	Go to the main menu screen.
?	Enable/disable breadcrumbs.

Item	Description
	The temperatures are shown in circles. If the circle is grey, the corresponding operation (example: space heating) is currently not active.

Item	Description
Outdoor unit a2 a3 a1	a1  : Outdoor unit
	a2  : Quiet mode active
	a3 Measured ambient temperature
Indoor unit / domestic hot water tank b2 b1	b1 Indoor unit: <ul style="list-style-type: none"> ▪ : Floor-standing indoor unit with integrated tank ▪ : Wall-mounted indoor unit with separated tank ▪ : Wall-mounted indoor unit
	b2 Water pressure
Space operation mode	c <ul style="list-style-type: none"> ▪ : Cooling ▪ : Heating
Disinfection / Powerful	d <ul style="list-style-type: none"> ▪ : Disinfection mode active ▪ : Powerful operation active
Date / time	e Current date and time
Holiday	f  : Holiday mode active
Main zone g3 g4 g1 g2	g1 Heat emitter type: <ul style="list-style-type: none"> ▪ : Underfloor heating ▪ : Fancoil unit ▪ : Radiator
	g2 Leaving water temperature setpoint
	g3 Room thermostat type: <ul style="list-style-type: none"> ▪ : Daikin user interface used as room thermostat ▪ : External control ▪ Hidden: Leaving water temperature control
	g4 Measured room temperature
Additional zone h3 h1 h2	h1 Heat emitter type: <ul style="list-style-type: none"> ▪ : Underfloor heating ▪ : Fancoil unit ▪ : Radiator
	h2 Leaving water temperature setpoint
	h3 Room thermostat type: <ul style="list-style-type: none"> ▪ : External control ▪ Hidden: Leaving water temperature control
Domestic hot water i1 i2	i1  : Domestic hot water
	i2 Measured tank temperature



Item		Description
Malfunction	j	 or  : A malfunction occurred See "14.4.1 To display the help text in case of a malfunction" [▶ 191] for more information.



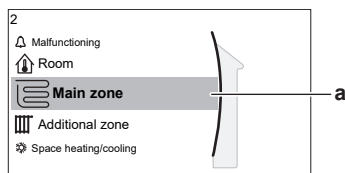



10.3.3 Main menu screen

Starting from the home screen, press () or turn () the left dial to open the main menu screen. From the main menu, you can access the different setpoint screens and submenus.



a Selected submenu

Possible actions on this screen	
	Go through the list.
	Enter the submenu.
?	Enable/disable breadcrumbs.

Submenu	Description
[0]  or  Malfunctioning	Restriction: Only displayed if a malfunction occurs. See "14.4.1 To display the help text in case of a malfunction" [▶ 191] for more information.
[1]  Room	Restriction: Only displayed if a room thermostat is connected to the indoor unit. Set the room temperature.
[2]  Main zone	Shows the applicable symbol for your main zone emitter type. Set the leaving water temperature for the main zone.
[3]  Additional zone	Restriction: Only displayed if there are two leaving water temperature zones. Shows the applicable symbol for your additional zone emitter type. Set the leaving water temperature for the additional zone (if present).
[4]  Space heating/cooling	Shows the applicable symbol for your unit. Put the unit in heating mode or cooling mode. You cannot change the mode on heating only models.
[5]  Tank	Restriction: Only displayed if a domestic hot water tank is present. Set the domestic hot water tank temperature.

Submenu		Description
[7]	User settings	Gives access to user settings such as holiday mode and quiet mode.
[8]	Information	Displays data and information about the indoor unit.
[9]	Installer settings	Restriction: Only for the installer. Gives access to advanced settings.
[A]	Commissioning	Restriction: Only for the installer. Perform tests and maintenance.
[B]	User profile	Change the active user profile.
[C]	Operation	Turn heating/cooling functionality and domestic hot water preparation on or off.

10.3.4 Menu screen

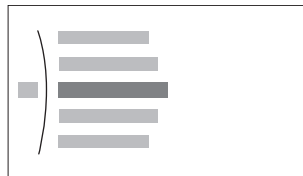

Example:

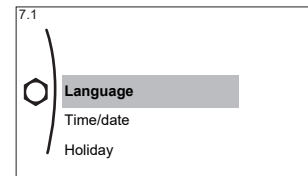

Possible actions on this screen	
	Go through the list.
	Enter the submenu/setting.

10.3.5 Setpoint screen

The setpoint screen is displayed for screens describing system components that need a setpoint value.

Examples

[1] Room temperature screen

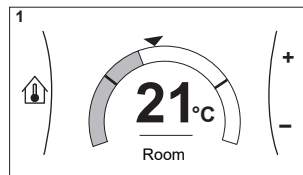

[2] Main zone screen

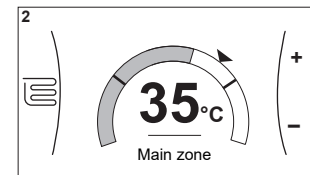

[3] Additional zone screen

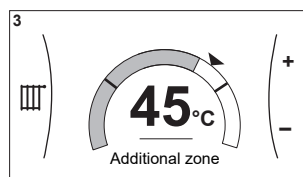

[5] Tank temperature screen

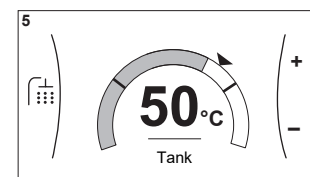

Explanation

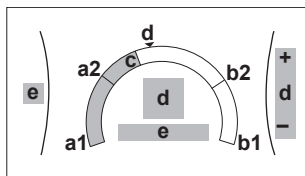

Possible actions on this screen	
	Go through the list of the submenu.
	Go to the submenu.
	Adjust and automatically apply the desired temperature.

Item	Description	
Minimum temperature limit	a1	Fixed by the unit
	a2	Restricted by the installer
Maximum temperature limit	b1	Fixed by the unit
	b2	Restricted by the installer
Current temperature	c	Measured by the unit
Desired temperature	d	Turn the right dial to increase/decrease.
SubMenu	e	Turn or press the left dial to go to the submenu.

10.3.6 Detailed screen with values

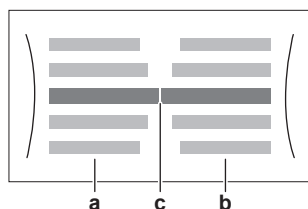

Example:

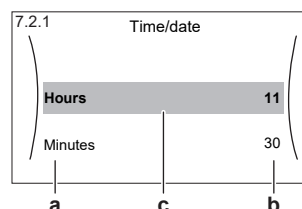

- a** Settings
- b** Values
- c** Selected setting and value

Possible actions on this screen	
	Go through the list of settings.
	Change the value.
	Go to the next setting.
	Confirm changes and proceed.

10.3.7 Schedule screen: Example

This example shows how to set a room temperature schedule in heating mode for the main zone.

**INFORMATION**

The procedures to program other schedules are similar.

To program the schedule: overview

Example: You want to program the following schedule:

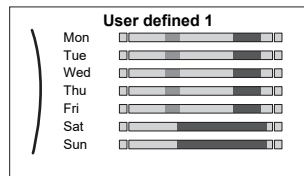

Prerequisite: The room temperature schedule is only available if room thermostat control is active. If leaving water temperature control is active, you can program the main zone schedule instead.

- 1 Go to the schedule.
- 2 (optional) Clear the content of the whole week schedule or the content of a selected day schedule.
- 3 Program the schedule for **Monday**.
- 4 Copy the schedule to the other weekdays.
- 5 Program the schedule for **Saturday** and copy it to **Sunday**.
- 6 Give the schedule a name.





To go to the schedule

1	Go to [1.1]: Room > Schedule.	
2	Set scheduling to Yes.	
3	Go to [1.2]: Room > Heating schedule.	



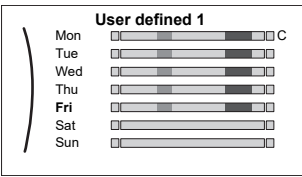



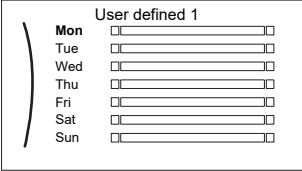

To clear the content of the week schedule

1	Select the name of the current schedule.	
2	Select Delete .	
3	Select OK to confirm.	



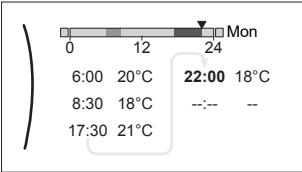



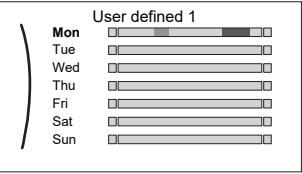

To clear the content of a day schedule

<p>1</p>	<p>Select the day of which you want to clear the content. For example Friday</p> 	
<p>2</p>	<p>Select Delete.</p> 	
<p>3</p>	<p>Select OK to confirm.</p>	

To program the schedule for Monday

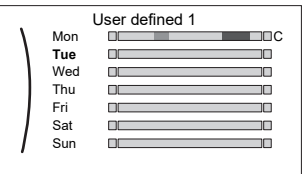

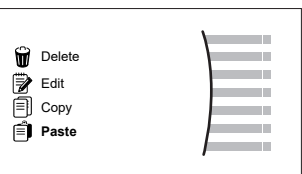
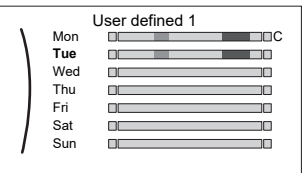

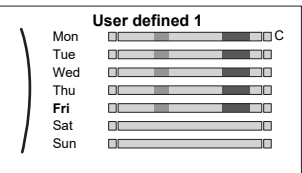

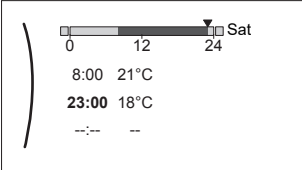

<p>1</p>	<p>Select Monday.</p> 	
<p>2</p>	<p>Select Edit.</p> 	
<p>3</p>	<p>Use the left dial to select an entry and edit the entry with the right dial. You can program up to 6 actions each day. On the bar, a high temperature has a darker colour than a low temperature.</p>  <p>Note: To clear an action, set its time as the time of the previous action.</p>	 
<p>4</p>	<p>Confirm the changes.</p> <p>Result: The schedule for Monday is defined. The value of the last action is valid until the next programmed action. In this example, Monday is the first day you programmed. Thus, the last programmed action is valid up to the first action of next Monday.</p>	

To copy the schedule to the other weekdays





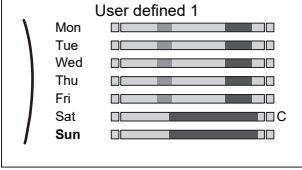

1	<p>Select Monday.</p> 	
2	<p>Select Copy.</p>  <p>Result: Next to the copied day, "C" is displayed.</p>	
3	<p>Select Tuesday.</p> 	
4	<p>Select Paste.</p>  <p>Result:</p> 	
5	<p>Repeat this action for all other weekdays.</p> 	<p>—</p>

To program the schedule for Saturday and copy it to Sunday

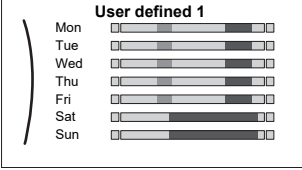
1	Select Saturday.	
2	Select Edit.	

<p>3</p>	<p>Use the left dial to select an entry and edit the entry with the right dial.</p> 	 
<p>4</p>	<p>Confirm the changes.</p>	
<p>5</p>	<p>Select Saturday.</p>	
<p>6</p>	<p>Select Copy.</p>	
<p>7</p>	<p>Select Sunday.</p>	
<p>8</p>	<p>Select Paste.</p> <p>Result:</p> 	

To rename the schedule

<p>1</p>	<p>Select the name of the current schedule.</p> 	
<p>2</p>	<p>Select Rename.</p> 	
<p>3</p>	<p>(optional) To delete the current schedule name, browse through the character list until ← is displayed, then press to remove the previous character. Repeat for each character of the schedule name.</p>	
<p>4</p>	<p>To name the current schedule, browse through the character list and confirm the selected character. The schedule name can contain up to 15 characters.</p>	
<p>5</p>	<p>Confirm the new name.</p>	

i **INFORMATION**
Not all schedules can be renamed.

10.4 Weather-dependent curve

10.4.1 What is a weather-dependent curve?

Weather-dependent operation

The unit operates 'weather dependent' if the desired leaving water or tank temperature is determined automatically by the outdoor temperature. It therefore is connected to a temperature sensor on the North wall of the building. If the outdoor temperature drops or rises, the unit compensates instantly. Thus, the unit does not have to wait for feedback by the thermostat to increase or decrease the temperature of the leaving water or tank. Because it reacts more quickly, it prevents high rises and drops of the indoor temperature and water temperature at tap points.

Advantage

Weather-dependent operation reduces energy consumption.

Weather-dependent curve

To be able to compensate for differences in temperature, the unit relies on its weather-dependent curve. This curve defines how much the temperature of the tank or leaving water must be at different outdoor temperatures. Because the slope of the curve depends on local circumstances such as climate and the insulation of the house, the curve can be adjusted by an installer or user.

Types of weather-dependent curve

There are 2 types of weather-dependent curves:

- 2-points curve
- Slope-offset curve

Which type of curve you use to make adjustments, depends on your personal preference. See "[10.4.4 Using weather-dependent curves](#)" [▶ 116].

Availability

The weather-dependent curve is available for:

- Main zone - Heating
- Main zone - Cooling
- Additional zone - Heating
- Additional zone - Cooling
- Tank (only available to installers)



INFORMATION

To operate weather dependent, correctly configure the setpoint of the main zone, additional zone or tank. See "[10.4.4 Using weather-dependent curves](#)" [▶ 116].

10.4.2 2-points curve

Define the weather-dependent curve with these two setpoints:

- Setpoint (X1, Y2)
- Setpoint (X2, Y1)

Example

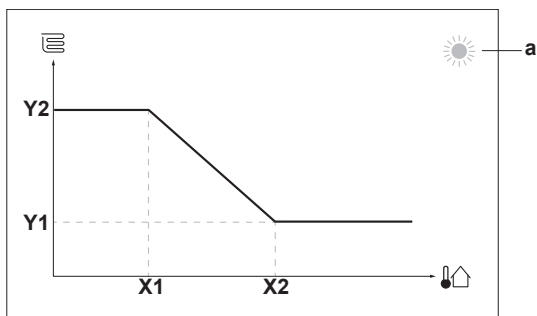

Item	Description
a	Selected weather dependent zone: <ul style="list-style-type: none"> ☀: Main zone or additional zone heating ❄: Main zone or additional zone cooling 🏠: Domestic hot water
X1, X2	Examples of outdoor ambient temperature
Y1, Y2	Examples of desired tank temperature or leaving water temperature. The icon corresponds to the heat emitter for that zone: <ul style="list-style-type: none"> 🏠: Underfloor heating 🌀: Fan coil unit 🔱: Radiator 🛀: Domestic hot water tank

Possible actions on this screen	
⏪...○	Go through the temperatures.
○...●⏩	Change the temperature.
○...🏠	Go to the next temperature.
🏠...○	Confirm changes and proceed.

10.4.3 Slope-offset curve

Slope and offset

Define the weather-dependent curve by its slope and offset:

- Change the **slope** to differently increase or decrease the temperature of the leaving water for different ambient temperatures. For example, if leaving water temperature is in general fine but at low ambient temperatures too cold, raise the slope so that leaving water temperature is heated increasingly more at decreasingly lower ambient temperatures.
- Change the **offset** to equally increase or decrease the temperature of the leaving water for different ambient temperatures. For example, if leaving water temperature is always a bit too cold at different ambient temperatures, shift the offset up to equally increase the leaving water temperature for all ambient temperatures.

Examples



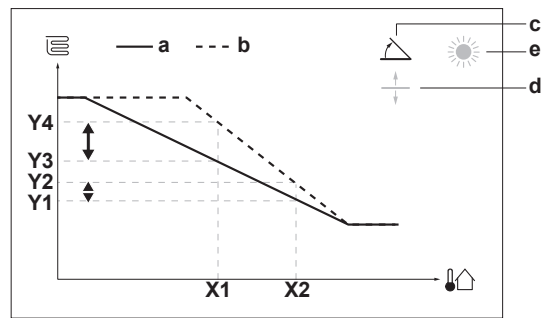

Weather-dependent curve when slope is selected:

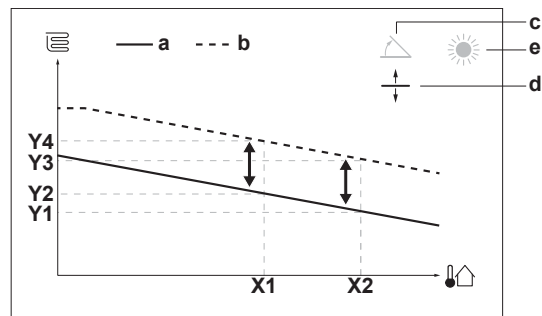

Weather-dependent curve when offset is selected:



Item	Description
a	WD curve before changes.
b	WD curve after changes (as example): <ul style="list-style-type: none"> ▪ When slope is changed, the new preferred temperature at X1 is unequally higher than the preferred temperature at X2. ▪ When offset is changed, the new preferred temperature at X1 is equally higher as the preferred temperature at X2.
c	Slope
d	Offset
e	Selected weather dependent zone: <ul style="list-style-type: none"> ▪ ☀: Main zone or additional zone heating ▪ ❄: Main zone or additional zone cooling ▪ 🏠: Domestic hot water
X1, X2	Examples of outdoor ambient temperature
Y1, Y2, Y3, Y4	Examples of desired tank temperature or leaving water temperature. The icon corresponds to the heat emitter for that zone: <ul style="list-style-type: none"> ▪ 🏠: Underfloor heating ▪ 📺: Fan coil unit ▪ 🏠: Radiator ▪ 🏠: Domestic hot water tank

Possible actions on this screen	
	Select slope or offset.
	Increase or decrease the slope/offset.
	When slope is selected: set slope and go to offset. When offset is selected: set offset.
	Confirm changes and return to the submenu.

10.4.4 Using weather-dependent curves

Configure weather-dependent curves as following:

To define the setpoint mode

To use the weather-dependent curve, you need to define the correct setpoint mode:

Go to setpoint mode ...	Set the setpoint mode to ...
Main zone – Heating	
[2.4] Main zone > Setpoint mode	WD heating, fixed cooling OR Weather dependent
Main zone – Cooling	
[2.4] Main zone > Setpoint mode	Weather dependent
Additional zone – Heating	
[3.4] Additional zone > Setpoint mode	WD heating, fixed cooling OR Weather dependent
Additional zone – Cooling	
[3.4] Additional zone > Setpoint mode	Weather dependent
Tank	
[5.B] Tank > Setpoint mode	Restriction: Only available to installers. Weather dependent

To change the type of weather-dependent curve

To change the type for all zones (main + additional) and for the tank, go to [2.E] Main zone > WD curve type.

Viewing which type is selected is also possible via:

- [3.C] Additional zone > WD curve type
- [5.E] Tank > WD curve type

Restriction: Only available to installers.

To change the weather-dependent curve

Zone	Go to ...
Main zone – Heating	[2.5] Main zone > Heating WD curve
Main zone – Cooling	[2.6] Main zone > Cooling WD curve

Zone	Go to ...
Additional zone – Heating	[3.5] Additional zone > Heating WD curve
Additional zone – Cooling	[3.6] Additional zone > Cooling WD curve
Tank	Restriction: Only available to installers. [5.C] Tank > WD curve



INFORMATION

Maximum and minimum setpoints

You cannot configure the curve with temperatures that are higher or lower than the set maximum and minimum setpoints for that zone or for the tank. When the maximum or minimum setpoint is reached, the curve flattens out.

To fine-tune the weather-dependent curve: slope-offset curve

The following table describes how to fine-tune the weather-dependent curve of a zone or tank:

You feel ...		Fine-tune with slope and offset:	
At regular outdoor temperatures ...	At cold outdoor temperatures ...	Slope	Offset
OK	Cold	↑	—
OK	Hot	↓	—
Cold	OK	↓	↑
Cold	Cold	—	↑
Cold	Hot	↓	↑
Hot	OK	↑	↓
Hot	Cold	↑	↓
Hot	Hot	—	↓

To fine-tune the weather-dependent curve: 2-points curve

The following table describes how to fine-tune the weather-dependent curve of a zone or tank:



You feel ...		Fine-tune with setpoints:			
At regular outdoor temperatures ...	At cold outdoor temperatures ...	Y2 ^(a)	Y1 ^(a)	X1 ^(a)	X2 ^(a)
OK	Cold	↑	—	↑	—
OK	Hot	↓	—	↓	—
Cold	OK	—	↑	—	↑
Cold	Cold	↑	↑	↑	↑
Cold	Hot	↓	↑	↓	↑
Hot	OK	—	↓	—	↓
Hot	Cold	↑	↓	↑	↓
Hot	Hot	↓	↓	↓	↓

^(a) See ["10.4.2 2-points curve"](#) [▶ 113].

10.5 Settings menu

You can set additional settings using the main menu screen and its submenus. The most important settings are presented here.

10.5.1 Malfunctioning

In case of a malfunction,  or  will appear on the home screen. To display the error code, open the menu screen and go to [0] **Malfunctioning**. Press **?** for more information about the error.

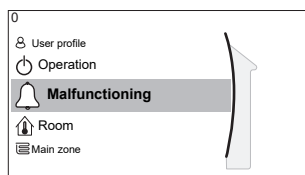

10.5.2 Room

Setpoint screen

Control the room temperature of the main zone via setpoint screen [1] **Room**.
See ["10.3.5 Setpoint screen"](#) [▶ 107].

Schedule

Indicate if the room temperature is controlled according to a schedule or not.

#	Code	Description
[1.1]	N/A	Schedule: <ul style="list-style-type: none"> ▪ No: Room temperature is directly controlled by the user. ▪ Yes: Room temperature is controlled by a schedule and can be modified by the user.

Heating schedule

Applicable for all models.

Define a heating schedule of the room temperature in [1.2] **Heating schedule**.
See ["10.3.7 Schedule screen: Example"](#) [▶ 108].

Cooling schedule

Only applicable for reversible models.

Define a cooling schedule of the room temperature in [1.3] **Cooling schedule**.
See ["10.3.7 Schedule screen: Example"](#) [▶ 108].

Antifrost

Room frost protection [1.4] prevents the room from getting too cold. This setting behaves differently depending on the set unit control method [2.9]. Perform actions according to the table below.

Main zone unit control method [2.9]	Description
Leaving water temperature control ([C-07]=0)	Room frost protection is NOT guaranteed.
External room thermostat control ([C-07]=1)	Allow for the external room thermostat to take care of room frost protection: <ul style="list-style-type: none"> Set [C.2] Space heating/cooling=0n.
Room thermostat control ([C-07]=2)	Allow for the user interface used as room thermostat to take care of room frost protection: <ul style="list-style-type: none"> Set antifrost [1.4.1] Activation=Yes. Set the temperature of the antifrost function in [1.4.2] Room setpoint.

**INFORMATION**

If a U4 error occurs, room frost protection is NOT guaranteed.

**NOTICE**

Room frost protection. Even if you turn OFF space heating/cooling operation ([C.2]: Operation > Space heating/cooling), room frost protection operation –if enabled– can still activate. However, for leaving water temperature control and external room thermostat control, the protection is NOT guaranteed.

For more detailed information about room frost protection in relation to the applicable unit control method, see the sections below.

Leaving water temperature control ([C-07]=0)

Under leaving water temperature control, room frost protection is NOT guaranteed. However, if room antifrost [1.4] is activated, limited frost protection by the unit is possible:

If...	Then...
Space heating/cooling is OFF and the outdoor ambient temperature drops below 4°C	The unit will supply leaving water to the heat emitters to heat up the room again, and the leaving water temperature setpoint will be lowered.
Space heating/cooling is ON and the operation mode is "heating"	The unit will supply leaving water to the heat emitters to heat up the room according to normal logic.
Space heating/cooling is ON and the operation mode is "cooling"	There is no room frost protection.

External room thermostat control ([C-07]=1)

Under external room thermostat control, room frost protection is guaranteed by the external room thermostat, provided that **Space heating/cooling** [C.2] is turned ON and the emergency setting [9.5] is set to automatic.

In case of one leaving water temperature zone:

If...	Then...
Space heating/cooling is OFF and the outdoor ambient temperature drops below 4°C	The unit will supply leaving water to the heat emitters to heat up the room again, and the leaving water temperature setpoint will be lowered.
Space heating/cooling is ON, the external room thermostat is "Thermo OFF" and the outdoor temperature drops below 4°C	The unit will supply leaving water to the heat emitters to heat up the room again, and the leaving water temperature setpoint will be lowered.
Space heating/cooling is ON and the external room thermostat is "Thermo ON"	Room frost protection is guaranteed by the normal logic.

In case of two leaving water temperature zones:

If...	Then...
Space heating/cooling is OFF and the outdoor ambient temperature drops below 4°C	The unit will supply leaving water to the heat emitters to heat up the room again, and the leaving water temperature setpoint will be lowered.
Space heating/cooling is ON, the external room thermostat is "Thermo OFF", the operation mode is "heating" and the outdoor temperature drops below 4°C	The unit will supply leaving water to the heat emitters to heat up the room again, and the leaving water temperature setpoint will be lowered.
Space heating/cooling is ON and the operation mode is "cooling"	There is no room frost protection.

Room thermostat control ([C-07]=2)

During room thermostat control, room frost protection [2-06] is guaranteed when activated. If so, and the room temperature drops below the room antifrost temperature [2-05], the unit will supply leaving water to the heat emitters to heat up the room again.

#	Code	Description
[1.4.1]	[2-06]	Activation: <ul style="list-style-type: none"> ▪ 0 No: Antifrost functionality is OFF. ▪ 1 Yes: Antifrost functionality is on.
[1.4.2]	[2-05]	Room setpoint: <ul style="list-style-type: none"> ▪ 4°C~16°C



INFORMATION

When the user interface used as room thermostat is disconnected (because of incorrect wiring or damage of the cable), then room frost protection is NOT guaranteed.

**NOTICE**

If **Emergency** is set to **Manual** ([9.5]=0), and the unit is triggered to start emergency operation, the unit will stop and need to be recovered manually via the user interface. To recover operation manually, go to the **Malfunctioning** main menu screen, where the user interface will then ask you to confirm emergency operation before starting.

Room frost protection is active even if the user does NOT confirm emergency operation.

Setpoint range

Only applicable in room thermostat control.

To save energy by preventing overheating or undercooling the room, you can limit the range of the room temperature for heating and/or cooling.

**NOTICE**

When adjusting the room temperature ranges, all desired room temperatures are also adjusted to guarantee they are between the limits.

#	Code	Description
[1.5.1]	[3-07]	Heating minimum
[1.5.2]	[3-06]	Heating maximum
[1.5.3]	[3-09]	Cooling minimum
[1.5.4]	[3-08]	Cooling maximum

Room sensor offset

Only applicable in room thermostat control.

To calibrate the (external) room temperature sensor, give an offset to the value of the room thermistor as measured by the user interface used as room thermostat or by the external room sensor. The setting can be used to compensate for situations where the user interface used as room thermostat or the external room sensor cannot be installed at the ideal location.

See "[6.7 Setting up an external temperature sensor](#)" [[▶ 56](#)]).

#	Code	Description
[1.6]	[2-0A]	Room sensor offset (user interface used as room thermostat): Offset on the actual room temperature measured by the user interface used as room thermostat. <ul style="list-style-type: none"> ▪ $-5^{\circ}\text{C}\sim 5^{\circ}\text{C}$, step 0.5°C
[1.7]	[2-09]	Room sensor offset (external room sensor option): Only applicable if the external room sensor option is installed and configured. <ul style="list-style-type: none"> ▪ $-5^{\circ}\text{C}\sim 5^{\circ}\text{C}$, step 0.5°C

10.5.3 Main zone

Setpoint screen

Control the leaving water temperature for the main zone via setpoint screen [2] **Main zone**.

See "[10.3.5 Setpoint screen](#)" [[▶ 107](#)].

Schedule

Indicate if the temperature of the leaving water is defined according to a schedule or not.

Influence of the LWT setpoint mode [2.4] is as follows:

- In **Fixed** LWT setpoint mode, the scheduled actions consist of desired leaving water temperatures, either preset or custom.
- In **Weather dependent** LWT setpoint mode, the scheduled actions consist of desired shift actions, either preset or custom.

#	Code	Description
[2.1]	N/A	Schedule: <ul style="list-style-type: none"> ▪ 0: No ▪ 1: Yes

Heating schedule

Define a heating temperature schedule for the main zone via [2.2] **Heating schedule**.

See "[10.3.7 Schedule screen: Example](#)" [▶ 108].

Cooling schedule

Define a cooling temperature schedule for the main zone via [2.3] **Cooling schedule**.

See "[10.3.7 Schedule screen: Example](#)" [▶ 108].

Setpoint mode

Define the setpoint mode:

- **Fixed:** the desired leaving water temperature does not depend on the outdoor ambient temperature.
- In **WD heating, fixed cooling** mode, the desired leaving water temperature:
 - depends on the outdoor ambient temperature for heating
 - does NOT depend on the outdoor ambient temperature for cooling
- In **Weather dependent** mode, the desired leaving water temperature depends on the outdoor ambient temperature.

#	Code	Description
[2.4]	N/A	Setpoint mode: <ul style="list-style-type: none"> ▪ Fixed ▪ WD heating, fixed cooling ▪ Weather dependent

When weather dependent operation is active, low outdoor temperatures will result in warmer water and vice versa. During weather dependent operation, the user can shift the water temperature up or down by a maximum of 10°C.

Heating WD curve

Set weather-dependent heating for the main zone (if [2.4]=1 or 2):

#	Code	Description
[2.5]	[1-00] [1-01] [1-02] [1-03]	<p>Set weather-dependent heating in [2.5] Heating WD curve:</p> <p>T_t Target leaving water temperature (main zone) T_a Outdoor temperature</p> <p>Set weather-dependent heating in [9.l] Overview field settings:</p> <ul style="list-style-type: none"> ▪ [1-00]: Low outdoor ambient temperature. $-40^{\circ}\text{C}\sim+5^{\circ}\text{C}$ ▪ [1-01]: High outdoor ambient temperature. $10^{\circ}\text{C}\sim25^{\circ}\text{C}$ ▪ [1-02]: Desired leaving water temperature when the outdoor temperature equals or drops below the low ambient temperature. $[9-01]^{\circ}\text{C}\sim[9-00]^{\circ}\text{C}$ <p>Note: This value should be higher than [1-03] as for low outdoor temperatures warmer water is required.</p> <ul style="list-style-type: none"> ▪ [1-03]: Desired leaving water temperature when the outdoor temperature equals or rises above the high ambient temperature. $[9-01]^{\circ}\text{C}\sim\min(45, [9-00])^{\circ}\text{C}$ <p>Note: This value should be lower than [1-02] as for high outdoor temperatures less warm water is required.</p>

Cooling WD curve

Set weather-dependent cooling for the main zone (if [2.4]=2):

#	Code	Description
[2.6]	[1-06] [1-07] [1-08] [1-09]	<p>Set weather-dependent cooling in [2.6] Cooling WD curve:</p> <p>T_t Target leaving water temperature (main zone) T_a Outdoor temperature</p> <p>Set weather-dependent heating in [9.1] Overview field settings:</p> <ul style="list-style-type: none"> ▪ [1-06]: Low outdoor ambient temperature. 10°C~25°C ▪ [1-07]: High outdoor ambient temperature. 25°C~43°C ▪ [1-08]: Desired leaving water temperature when the outdoor temperature equals or drops below the low ambient temperature. [9-03]°C~[9-02]°C <p>Note: This value should be higher than [1-09] as for low outdoor temperatures less cold water is required.</p> <ul style="list-style-type: none"> ▪ [1-09]: Desired leaving water temperature when the outdoor temperature equals or rises above the high ambient temperature. [9-03]°C~[9-02]°C <p>Note: This value should be lower than [1-08] as for high outdoor temperatures colder water is required.</p>

Emitter type

Heating up or cooling down the main zone can take longer. This depends on:

- The water volume of the system
- The heater emitter type of the main zone

The setting **Emitter type** can compensate for a slow or a quick heating/cooling system during the heat up/cool down cycle. In room thermostat control, **Emitter type** influences the maximum modulation of the desired leaving water temperature, and the possibility for usage of the automatic cooling/heating changeover based on the indoor ambient temperature.

It is important to set **Emitter type** correctly and in accordance with your system layout. The target delta T for the main zone depends on it.

#	Code	Description
[2.7]	[2-0C]	Emitter type: <ul style="list-style-type: none"> ▪ 0: Underfloor heating ▪ 1: Fancoil unit ▪ 2: Radiator

The setting **Emitter type** influences the space heating setpoint range and the target delta T in heating as follows:

Emitter type Main zone	Space heating setpoint range [9-01]~[9-00]	Target delta T in heating [1-0B]
0: Underfloor heating	Maximum 55°C	Variable (see [2.B.1])
1: Fancoil unit	Maximum 55°C	Variable (see [2.B.1])
2: Radiator	Maximum 60°C	Fixed 8°C



NOTICE

The maximum setpoint in space heating depends on the emitter type as can be seen in above table. If there are 2 water temperature zones, then the maximum setpoint is the maximum of the 2 zones.



NOTICE

NOT configuring the system in the following way can cause damage to the heat emitters. If there are 2 zones, it is important that in heating:

- the zone with the lowest water temperature is configured as the main zone, and
- the zone with the highest water temperature is configured as the additional zone.



NOTICE

If there are 2 zones and the emitter types are wrongly configured, water of high temperature can be sent towards a low temperature emitter (underfloor heating). To avoid this:

- Install an aquastat/thermostatic valve to avoid too high temperatures towards a low temperature emitter.
- Make sure you set the emitter types for the main zone [2.7] and for the additional zone [3.7] correctly in accordance with the connected emitter.



NOTICE

Average emitter temperature = Leaving water temperature – (Delta T)/2

This means that for a same leaving water temperature setpoint, the average emitter temperature of radiators is lower than that of underfloor heating because of a bigger delta T.

Example radiators: $40 - 8 / 2 = 36^{\circ}\text{C}$

Example underfloor heating: $40 - 5 / 2 = 37.5^{\circ}\text{C}$

To compensate, you can:

- Increase the weather-dependent curve desired temperatures [2.5].
- Enable leaving water temperature modulation and increase the maximum modulation [2.C].

Setpoint range

To prevent a wrong (i.e. too hot or too cold) leaving water temperature for the main leaving water temperature zone, limit its temperature range.



NOTICE

In case of a floor heating application it is important to limit the:

- maximum leaving water temperature at heating operation according to the specifications of the floor heating installation.
- the minimum leaving water temperature at cooling operation to 18~20°C to prevent condensation on the floor.



NOTICE

- When adjusting the leaving water temperature ranges, all desired leaving water temperatures are also adjusted to guarantee they are between the limits.
- Always balance between the desired leaving water temperature with the desired room temperature and/or the capacity (according to the design and selection of the heat emitters). The desired leaving water temperature is the result of several settings (preset values, shift values, weather-dependent curves, modulation). As a result, too high or too low leaving water temperatures could occur which lead to overtemperatures or capacity shortage. By limiting the leaving water temperature range to adequate values (depending on the heat emitter), such situations can be avoided.

Example: In heating mode, leaving water temperatures must be sufficiently higher than the room temperatures. To avoid that the room cannot heat up as desired, set the minimum leaving water temperature to 28°C.

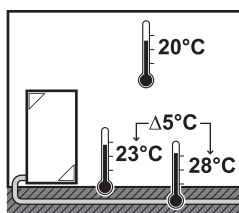

#	Code	Description
Leaving water temperature range for the main leaving water temperature zone (= the leaving water temperature zone with the lowest leaving water temperature in heating operation and the highest leaving water temperature in cooling operation)		
[2.8.1]	[9-01]	Heating minimum: <ul style="list-style-type: none"> ▪ 15°C~37°C
[2.8.2]	[9-00]	Heating maximum: <ul style="list-style-type: none"> ▪ [2-0C]=2 (emitter type main zone = radiator) 37°C~60°C ▪ Else: 37°C~55°C
[2.8.3]	[9-03]	Cooling minimum: <ul style="list-style-type: none"> ▪ 5°C~18°C
[2.8.4]	[9-02]	Cooling maximum: <ul style="list-style-type: none"> ▪ 18°C~22°C

Control

Define how the operation of the unit is controlled.

Control	In this control...
Leaving water	Unit operation is decided based on the leaving water temperature regardless the actual room temperature and/or heating or cooling demand of the room.
External room thermostat	Unit operation is decided by the external thermostat or equivalent (e.g. heat pump convector).
Room thermostat	Unit operation is decided based on the ambient temperature of the user interface used as a room thermostat.

#	Code	Description
[2.9]	[C-07]	<ul style="list-style-type: none"> ▪ 0: Leaving water ▪ 1: External room thermostat ▪ 2: Room thermostat

Thermostat type

Only applicable in external room thermostat control.



NOTICE

If an external room thermostat is used, the external room thermostat will control the room frost protection. However, the room frost protection is only possible if [C.2] Space heating/cooling=On.

#	Code	Description
[2.A]	[C-05]	<p>External room thermostat type for the main zone:</p> <ul style="list-style-type: none"> ▪ 1: 1 contact: The used external room thermostat can only send a thermo ON/OFF condition. There is no separation between heating or cooling demand. The room thermostat is connected to only 1 digital input (X2M/35). Select this value in case of a connection to the heat pump convector (FWXV). ▪ 2: 2 contacts: The used external room thermostat can send a separate heating/cooling thermo ON/OFF condition. The room thermostat is connected to 2 digital inputs (X2M/35 and X2M/34). Select this value in case of a connection to the wired (EKRTWA) or wireless (EKTR1) room thermostat

Leaving water temperature: Delta T

In heating for the main zone, the target delta T (temperature difference) depends on the selected emitter type for the main zone.

Delta T is the absolute value of the temperature difference between the leaving water and entering water.

The unit is designed to support underfloor loops operation. The recommended leaving water temperature for underfloor loops is 35°C. In such case, the unit will realize a temperature difference of 5°C, which means that the entering water temperature is around 30°C.

Depending on the installed type of heat emitters (radiators, heat pump convector, underfloor loops) or situation, you can change the difference between entering and leaving water temperature.

Note: The pump will regulate its flow to keep the delta T. In some special cases, the measured delta T can differ from the set value.



INFORMATION

When only the backup heater is active in heating, delta T will be controlled according to the fixed capacity of the backup heater. It is possible that this delta T is different from the selected target delta T.



INFORMATION

In heating, the target delta T will only be achieved after some operation time, when the setpoint is being reached, because of the big difference between leaving water temperature setpoint and inlet temperature at startup.

#	Code	Description
[2.B.1]	[1-0B]	<p>Delta T heating: A minimum temperature difference is required for proper operation of heat emitters in heating mode.</p> <ul style="list-style-type: none"> ▪ If [2-0C]=2, this is fixed to 8°C ▪ Else: 3°C~10°C
[2.B.2]	[1-0D]	<p>Delta T cooling: A minimum temperature difference is required for proper operation of heat emitters in cooling mode.</p> <ul style="list-style-type: none"> ▪ 3°C~10°C

Leaving water temperature: Modulation

Only applicable in case of room thermostat control.

When using the room thermostat functionality, the customer needs to set the desired room temperature. The unit will supply hot water to the heat emitters and the room will be heated.

Additionally, also the desired leaving water temperature must be configured: if **Modulation** is enabled, the unit automatically calculates the desired leaving water temperature. These calculations are based on:

- the preset temperatures, or
- the desired weather-dependent temperatures (if weather-dependent is enabled)

Moreover, with **Modulation** enabled, the desired leaving water temperature is lowered or raised in function of the desired room temperature and the difference between the actual and the desired room temperature. This results in:

- stable room temperatures, exactly matching the desired temperature (higher comfort level)
- less on/off cycles (lower noise level, higher comfort and higher efficiency)
- water temperatures as low as possible to match the desired temperature (higher efficiency)

If **Modulation** is disabled, set the desired leaving water temperature via [2] **Main zone**.

#	Code	Description
[2.C.1]	[8-05]	Modulation: <ul style="list-style-type: none"> 0 No (disabled) 1 Yes (enabled) Note: The desired leaving water temperature can only be read out on the user interface.
[2.C.2]	[8-06]	Max modulation: <ul style="list-style-type: none"> 0°C~10°C This is the temperature value by which the desired leaving water temperature is increased or decreased.



INFORMATION

When leaving water temperature modulation is enabled, the weather-dependent curve needs to be set to a higher position than [8-06] plus the minimum leaving water temperature setpoint required to reach a stable condition on the comfort setpoint for the room. To increase efficiency, modulation can lower the leaving water setpoint. By setting the weather-dependent curve to a higher position, it cannot drop below the minimum setpoint. See the illustration below.

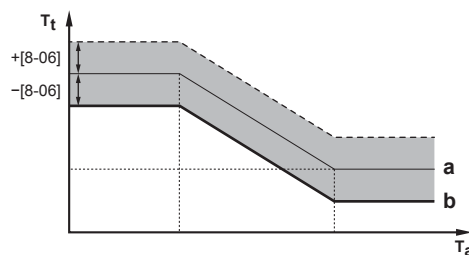

- a Weather-dependent curve
- b Minimum leaving water temperature setpoint required to reach a stable condition on the comfort setpoint for the room.

Shut off valve

The following is only applicable in case of 2 leaving water temperature zones. In case of 1 leaving water temperature zone, connect the shut-off valve to the heating/cooling output.

The shut off valve for the main leaving water temperature zone can close under these circumstances:



INFORMATION

During defrost operation, the shut-off valve is ALWAYS opened.

During thermo: If [F-0B] is enabled, the shut off valve closes when there is no heating demand from the main zone. Enable this setting to:

- avoid leaving water supply to the heat emitters in the main LWT zone (through the mixing valve station) when there is request from the additional LWT zone.
- activate the ON/OFF pump of the mixing valve station ONLY when there is demand.

#	Code	Description
[2.D.1]	[F-0B]	The shut off valve: <ul style="list-style-type: none"> 0 No: is NOT influenced by heating or cooling demand. 1 Yes: closes when there is NO heating or cooling demand.



INFORMATION

The setting [F-0B] is only valid when there is a thermostat or external room thermostat request setting (NOT in case of leaving water temperature setting).

10.5.4 Additional zone

Setpoint screen

Control the leaving water temperature for the additional zone via setpoint screen [3] **Additional zone**.

See "[10.3.5 Setpoint screen](#)" [▶ 107].

Schedule

Indicates if the desired leaving water temperature is according to a schedule.

See "[10.5.3 Main zone](#)" [▶ 121].

#	Code	Description
[3.1]	N/A	Schedule: <ul style="list-style-type: none"> No Yes

Heating schedule

Define a heating temperature schedule for the additional zone via [3.2] **Heating schedule**.

See "[10.3.7 Schedule screen: Example](#)" [▶ 108].

Cooling schedule

Define a cooling temperature schedule for the additional zone via [3.3] **Cooling schedule**.

See "[10.3.7 Schedule screen: Example](#)" [▶ 108].

Setpoint mode

The setpoint mode of the additional zone can be independently set from the setpoint mode of the main zone.

See "[Setpoint mode](#)" [▶ 122].

#	Code	Description
[3.4]	N/A	Setpoint mode: <ul style="list-style-type: none"> Fixed WD heating, fixed cooling Weather dependent

Heating WD curve

Set weather-dependent heating for the additional zone (if [3.4]=1 or 2):

#	Code	Description
[3.5]	[0-00] [0-01] [0-02] [0-03]	<p>Set weather-dependent heating:</p> <ul style="list-style-type: none"> ▪ T_t: Target leaving water temperature (additional zone) ▪ T_a: Outdoor temperature ▪ [0-03]: Low outdoor ambient temperature. $-40^{\circ}\text{C}\sim+5^{\circ}\text{C}$ ▪ [0-02]: High outdoor ambient temperature. $10^{\circ}\text{C}\sim25^{\circ}\text{C}$ ▪ [0-01]: Desired leaving water temperature when the outdoor temperature equals or drops below the low ambient temperature. $[9-05]^{\circ}\text{C}\sim[9-06]^{\circ}\text{C}$ <p>Note: This value should be higher than [0-00] as for low outdoor temperatures warmer water is required.</p> <ul style="list-style-type: none"> ▪ [0-00]: Desired leaving water temperature when the outdoor temperature equals or rises above the high ambient temperature. $[9-05]\sim\min(45, [9-06])^{\circ}\text{C}$ <p>Note: This value should be lower than [0-01] as for high outdoor temperatures less warm water is required.</p>

Cooling WD curve

Set weather-dependent cooling for the additional zone (if [3.4]=2):

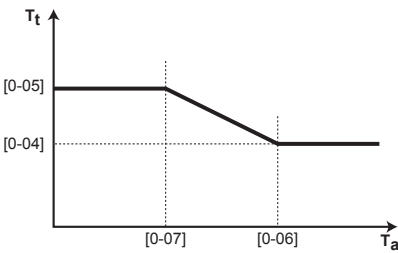
#	Code	Description
[3.6]	[0-04] [0-05] [0-06] [0-07]	<p>Set weather-dependent cooling:</p>  <ul style="list-style-type: none"> ▪ T_t: Target leaving water temperature (additional zone) ▪ T_a: Outdoor temperature ▪ [0-07]: Low outdoor ambient temperature. 10°C~25°C ▪ [0-06]: High outdoor ambient temperature. 25°C~43°C ▪ [0-05]: Desired leaving water temperature when the outdoor temperature equals or drops below the low ambient temperature. [9-07]°C~[9-08]°C <p>Note: This value should be higher than [0-04] as for low outdoor temperatures less cold water is required.</p> <ul style="list-style-type: none"> ▪ [0-04]: Desired leaving water temperature when the outdoor temperature equals or rises above the high ambient temperature. [9-07]°C~[9-08]°C <p>Note: This value should be lower than [0-05] as for high outdoor temperatures colder water is required.</p>

Emitter type

For more information about **Emitter type**, see "10.5.3 Main zone" [▶ 121].

#	Code	Description
[3.7]	[2-0D]	<p>Emitter type:</p> <ul style="list-style-type: none"> ▪ 0: Underfloor heating ▪ 1: Fancoil unit ▪ 2: Radiator

The setting of the emitter type has an influence on the space heating setpoint range and the target delta T in heating as follows:

Emitter type Additional zone	Space heating setpoint range [9-05]~[9-06]	Target delta T in heating [1-0C]
0: Underfloor heating	Maximum 55°C	Variable (see [3.B.1])
1: Fancoil unit	Maximum 55°C	Variable (see [3.B.1])
2: Radiator	Maximum 65°C	Fixed 8°C

Setpoint range

For more information about **Setpoint range**, see "10.5.3 Main zone" [▶ 121].

#	Code	Description
		Leaving water temperature range for the additional leaving water temperature zone (= the leaving water temperature zone with the highest leaving water temperature in heating operation and the lowest leaving water temperature in cooling operation)
[3.8.1]	[9-05]	Heating minimum: 15°C~37°C
[3.8.2]	[9-06]	Heating maximum <ul style="list-style-type: none"> ▪ [2-0D]=2 (emitter type additional zone = radiator) 37°C~60°C ▪ Else: 37°C~55°C
[3.8.3]	[9-07]	Cooling minimum <ul style="list-style-type: none"> ▪ 5°C~18°C
[3.8.4]	[9-08]	Cooling maximum <ul style="list-style-type: none"> ▪ 18°C~22°C

Control

The control type for the additional zone is read only. It is determined by the control type of the main zone.

See "10.5.3 Main zone" [▶ 121].

#	Code	Description
[3.9]	N/A	Control: <ul style="list-style-type: none"> ▪ Leaving water if the control type of the main zone is Leaving water. ▪ External room thermostat if the control type of the main zone is: <ul style="list-style-type: none"> - External room thermostat, or - Room thermostat.

Thermostat type

Only applicable in external room thermostat control.

Also see "10.5.3 Main zone" [▶ 121].

#	Code	Description
[3.A]	[C-06]	External room thermostat type for the additional zone: <ul style="list-style-type: none"> ▪ 1: 1 contact. Connected to only 1 digital input (X2M/35a) ▪ 2: 2 contacts. Connected to 2 digital inputs (X2M/34a and X2M/35a)

Leaving water temperature: Delta T

For more information, see "10.5.3 Main zone" [▶ 121].

#	Code	Description
[3.B.1]	[1-0C]	Delta T heating: A minimum temperature difference is required for the good operation of heat emitters in heating mode. <ul style="list-style-type: none"> ▪ If [2-0D] = 2, this is fixed to 8°C ▪ Else: 3°C~10°C
[3.B.2]	[1-0E]	Delta T cooling: A minimum temperature difference is required for the good operation of heat emitters in cooling mode. <ul style="list-style-type: none"> ▪ 3°C~10°C



10.5.5 Space heating/cooling

About space operation modes

Your unit can be a heating or a heating/cooling model:

- If your unit is a heating model, it can heat up a space.
- If your unit is a heating/cooling model, it can both heat up and cool down a space. You have to tell the system which operation mode to use.

To determine if a heating/cooling heat pump model is installed



1	Go to [4]: Space heating/cooling.	
2	Check if [4.1] Operation mode is listed and editable. If so, a heating/cooling heat pump model is installed.	

To tell the system which space operation to use, you can:

You can...	Location
Check which space operation mode is currently used.	Home screen
Set the space operation mode permanently.	Main menu
Restrict automatic changeover according to a monthly schedule.	

To check which space operation mode is currently used

The space operation mode is displayed on the home screen:

- When the unit is in heating mode, the  icon is shown.
- When the unit is in cooling mode, the  icon is shown.

The status indicator shows if the unit is currently in operation:

- When the unit is not in operation, the status indicator will show a blue pulsation with an interval of approximately 5 seconds.
- While the unit is in operation, the status indicator will light up blue constantly.

To set the space operation mode





1	Go to [4.1]: Space heating/cooling > Operation mode	
----------	---	---

2	Select one of the following options: <ul style="list-style-type: none"> ▪ Heating: Only heating mode ▪ Cooling: Only cooling mode ▪ Automatic: The operation mode changes automatically between heating and cooling based on the outdoor temperature. Restricted per month according to the Operation mode schedule [4.2]. 	
----------	---	---

When **Automatic** is selected, the unit switches its operation mode, based on the **Operation mode schedule** [4.2]. In this schedule, the end user indicates which operation is allowed for each month.

To restrict automatic changeover according to a schedule

Conditions: You set the space operation mode to **Automatic**.

1	Go to [4.2]: Space heating/cooling > Operation mode schedule .	
2	Select a month.	
3	For each month, select an option: <ul style="list-style-type: none"> ▪ Reversible: Not restricted ▪ Heating only: Restricted ▪ Cooling only: Restricted 	
4	Confirm the changes.	

Example: Changeover restrictions

When	Restriction
During cold season. Example: October, November, December, January, February and March.	Heating only
During warm season. Example: June, July and August.	Cooling only
In-between. Example: April, May and September.	Reversible

The unit determines its operation mode by the outdoor temperature if:

- **Operation mode=Automatic**, and
- **Operation mode schedule=Reversible**.

The unit determines its operation mode in such a way that it will always stay within the following operation ranges:

- **Space heating off temperature**
- **Space cooling off temperature**

The outdoor temperature is time-averaged. If the outdoor temperature drops, the operation mode will switch to heating and vice versa.

If the outdoor temperature is between the **Space heating off temperature** and the **Space cooling off temperature**, the operation mode remains unchanged.

Operation range

Depending on the average outdoor temperature, the operation of the unit in space heating or space cooling is prohibited.

#	Code	Description
[4.3.1]	[4-02]	Space heating off temperature: When the averaged outdoor temperature rises above this value, space heating is turned off. ^(a) <ul style="list-style-type: none"> 14°C~35°C
[4.3.2]	[F-01]	Space cooling off temperature: When the averaged outdoor temperature drops below this value, space cooling is turned off. ^(a) <ul style="list-style-type: none"> 10°C~35°C

^(a) This setting is also used in automatic heating/cooling changeover.

Exception: If the system is configured in room thermostat control with one leaving water temperature zone and quick heat emitters, the operation mode will change based on the measured indoor temperature. Besides the desired heating/cooling room temperature, the installer sets a hysteresis value (e.g. when in heating, this value is related to the desired cooling temperature) and an offset value (e.g. when in heating, this value is related to the desired heating temperature).

Example: A unit is configured as following:

- Desired room temperature in heating mode: 22°C
- Desired room temperature in cooling mode: 24°C
- Hysteresis value: 1°C
- Offset: 4°C

Changeover from heating to cooling will occur when the room temperature rises above the maximum of the desired cooling temperature added by the hysteresis value (thus $24+1=25^{\circ}\text{C}$) and the desired heating temperature added by the offset value (thus $22+4=26^{\circ}\text{C}$).

Oppositely, changeover from cooling to heating will occur when the room temperature drops below the minimum of the desired heating temperature subtracted by the hysteresis value (thus $22-1=21^{\circ}\text{C}$) and the desired cooling temperature subtracted by the offset value (thus $24-4=20^{\circ}\text{C}$).

Guard timer to prevent too frequent changing from heating to cooling and vice versa.

#	Code	Description
Changeover settings related to the indoor temperature. Only applicable when Automatic is selected and the system is configured in room thermostat control with 1 leaving water temperature zone and quick heat emitters.		
N/A	[4-0B]	Hysteresis: ensures that changeover is only done when necessary. The space operation only changes from heating to cooling when the room temperature rises above the desired cooling temperature added by the hysteresis value. <ul style="list-style-type: none"> Range: 1°C~10°C

#	Code	Description
N/A	[4-0D]	<p>Offset: ensures that the active desired room temperature is always reached.</p> <p>In heating mode, the space operation only changes when the room temperature rises above the desired heating temperature added by the offset value.</p> <ul style="list-style-type: none"> Range: 1°C~10°C

Number of zones

The system can supply leaving water to up to 2 water temperature zones. During configuration, the number of water zones must be set.

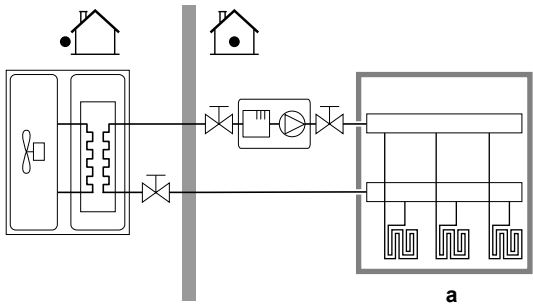
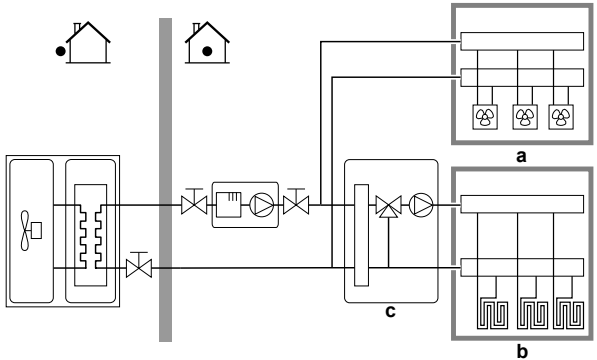
#	Code	Description
[4.4]	[7-02]	<ul style="list-style-type: none"> 0: Single zone <p>Only one leaving water temperature zone:</p>  <p>a Main LWT zone</p>
[4.4]	[7-02]	<ul style="list-style-type: none"> 1: Dual zone <p>Two leaving water temperature zones. The main leaving water temperature zone consists of the higher load heat emitters and a mixing station to achieve the desired leaving water temperature. In heating:</p>  <p>a Additional LWT zone: Highest temperature b Main LWT zone: Lowest temperature c Mixing station</p>



NOTICE

NOT configuring the system in the following way can cause damage to the heat emitters. If there are 2 zones, it is important that in heating:

- the zone with the lowest water temperature is configured as the main zone, and
- the zone with the highest water temperature is configured as the additional zone.



NOTICE

If there are 2 zones and the emitter types are wrongly configured, water of high temperature can be sent towards a low temperature emitter (underfloor heating). To avoid this:

- Install an aquastat/thermostatic valve to avoid too high temperatures towards a low temperature emitter.
- Make sure you set the emitter types for the main zone [2.7] and for the additional zone [3.7] correctly in accordance with the connected emitter.

Pump operation mode

When the space heating/cooling operation is OFF, the pump is always OFF. When space heating/cooling operation is ON, you have the choice between these operation modes:

#	Code	Description
[4.5]	[F-0D]	<p>Pump operation mode:</p> <ul style="list-style-type: none"> ▪ 0 Continuous: Continuous pump operation, regardless of thermo ON or OFF condition. Remark: Continuous pump operation requires more energy than sample or request pump operation. <p>a Space heating/cooling control b Off c On d Pump operation</p>

#	Code	Description
[4.5]	[F-0D]	<ul style="list-style-type: none"> 1 Sample: The pump is ON when there is heating or cooling demand as the leaving water temperature has not yet reached the desired temperature yet. When thermo OFF condition occurs, the pump runs every 3 minutes to check the water temperature and demand heating or cooling if necessary. Remark: Sample is ONLY available in leaving water temperature control. <p> a Space heating/cooling control b Off c On d LWT temperature e Actual f Desired g Pump operation </p>
[4.5]	[F-0D]	<ul style="list-style-type: none"> 2 Request: Pump operation based on request. Example: Using a room thermostat and thermostat creates thermo ON/OFF condition. Remark: NOT available in leaving water temperature control. <p> a Space heating/cooling control b Off c On d Heating demand (by external room thermostat or room thermostat) e Pump operation </p>

Unit type

In this part of the menu it can be read out which type of unit is used:

#	Code	Description
[4.6]	[E-02]	Unit type: <ul style="list-style-type: none"> 0 Reversible 1 Heating only

Pump limitation

Pump speed limitation [9-0D] defines the maximum pump speed. In normal conditions, the default setting should NOT be modified. The pump speed limitation will be overruled when the flow rate is in the range of the minimum flow (error 7H).

In most cases, instead of using [9-0D], you can prevent flow noises by performing hydraulic balancing.

#	Code	Description
[4.7]	[9-0D]	Pump limitation Possible values: see below.

Possible values:

Value	Description
0	No limitation
1~4	General limitation. There is limitation in all conditions. The required delta T control and comfort are NOT guaranteed. <ul style="list-style-type: none"> ▪ 1: 90% pump speed ▪ 2: 80% pump speed ▪ 3: 70% pump speed ▪ 4: 60% pump speed
5~8	Limitation when no actuators. When there is no heating output, the pump speed limitation is applicable. When there is heating output, the pump speed is only determined by delta T in relation to the required capacity. With this limitation range, delta T is possible and the comfort is guaranteed. <p>During sampling operation the pump runs for a short time to measure the water temperatures, which indicate if operation is required or not.</p> <ul style="list-style-type: none"> ▪ 5: 90% pump speed during sampling ▪ 6: 80% pump speed during sampling ▪ 7: 70% pump speed during sampling ▪ 8: 60% pump speed during sampling

The maximum values depend on the unit type:

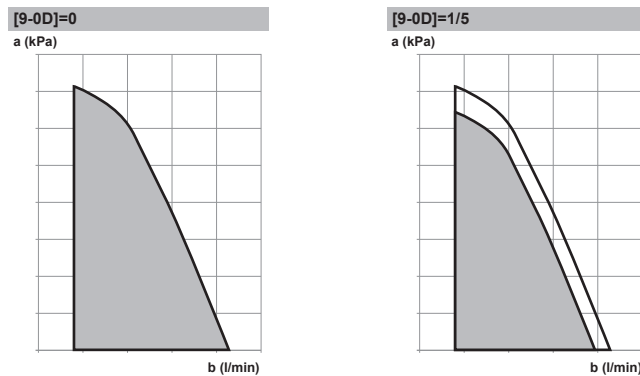

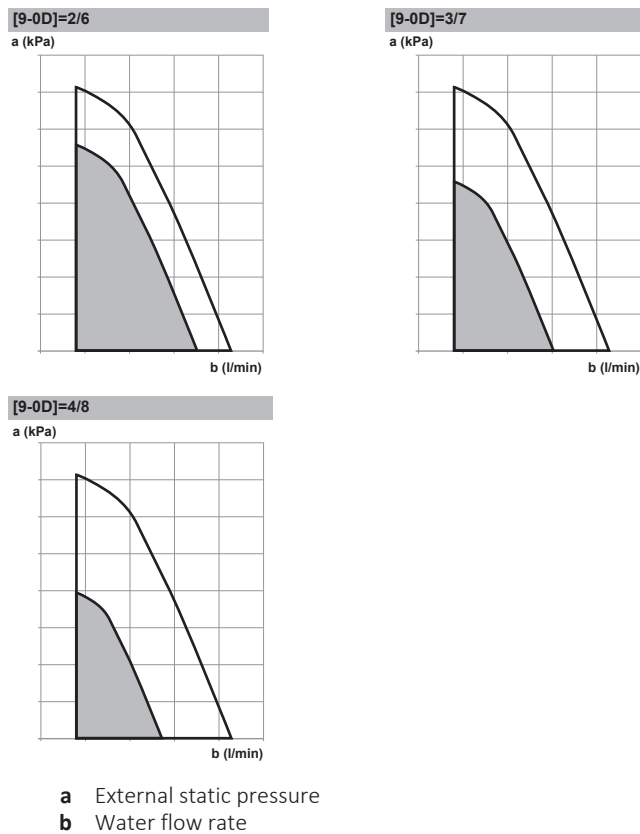

Pump outside range

When the pump operation function is disabled the pump will stop if the outdoor temperature is higher than the value set by the **Space heating off temperature** [4-02] or if the outdoor temperature drops below the value set by the **Space cooling off temperature** [F-01]. When the pump operation is enabled, the pump operation is possible at all outdoor temperatures.

#	Code	Description
[4.9]	[F-00]	Pump operation: <ul style="list-style-type: none"> ▪ 0: Disabled if outdoor temperature is higher than [4-02] or lower than [F-01] depending on heating/cooling operation mode. ▪ 1: Possible at all outdoor temperatures.

Increase around 0°C

Use this setting to compensate for possible heat losses of the building due to the evaporation of melted ice or snow. (e.g. in cold region countries).

In heating operation, the desired leaving water temperature is locally increased around an outdoor temperature of 0°C. This compensation can be selected when using an absolute or a weather dependent desired temperature (see illustration below).

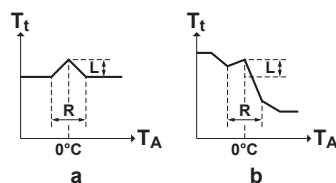

- a** Absolute desired LWT
b Weather dependent desired LWT

#	Code	Description
[4.A]	[D-03]	Increase around 0°C: <ul style="list-style-type: none"> ▪ 0: No ▪ 1: increase 2°C, span 4°C ▪ 2: increase 4°C, span 4°C ▪ 3: increase 2°C, span 8°C ▪ 4: increase 4°C, span 8°C

Overshoot

Restriction: This function is only applicable in heating mode.

This function defines how much the water temperature may rise above the desired leaving water temperature before the compressor stops. The compressor will start up again when the leaving water temperature drops below the desired leaving water temperature.

#	Code	Description
[4.B]	[9-04]	Overshoot: <ul style="list-style-type: none"> ▪ 1°C~4°C

Antifrost

Room frost protection [1.4] prevents the room from getting too cold. For more information about room frost protection, see "[10.5.2 Room](#)" [▶ 118].

10.5.6 Tank

Comfort setpoint

Only applicable when domestic hot water preparation is **Schedule only** or **Schedule + reheat**. When programming the schedule, you can make use of the comfort setpoint as a preset value. When you later want to change the storage setpoint, you only have to do it in one place.

The tank will heat up until the **storage comfort temperature** has been reached. It is the higher desired temperature when a storage comfort action is scheduled.

Additionally, a storage stop can be programmed. This feature puts a stop to tank heating even if the setpoint has NOT been reached. Only program a storage stop when tank heating is absolutely undesirable.

#	Code	Description
[5.2]	[6-0A]	Comfort setpoint: <ul style="list-style-type: none"> ▪ 30°C~[6-0E]°C

Eco setpoint

The **storage economic temperature** denotes the lower desired tank temperature. It is the desired temperature when a storage economic action is scheduled (preferably during day).

#	Code	Description
[5.3]	[6-0B]	Eco setpoint: <ul style="list-style-type: none"> ▪ 30°C~min(50,[6-0E])°C

Reheat setpoint

Desired reheat tank temperature, used:

- in **Schedule + reheat** mode, during reheat mode: the guaranteed minimum tank temperature is set by the **Reheat setpoint** minus the reheat hysteresis. If the tank temperature drops below this value, the tank is heated up.
- during storage comfort, to prioritize the domestic hot water preparation. When the tank temperature rises above this value, domestic hot water preparation and space heating/cooling are executed sequentially.

#	Code	Description
[5.4]	[6-0C]	Reheat setpoint: <ul style="list-style-type: none"> ▪ 30°C~min(50,[6-0E])°C

Schedule

You can set the tank temperature schedule using the schedule screen. For more information about this screen, see "[10.3.7 Schedule screen: Example](#)" [▶ 108].

Heat up mode

The domestic hot water can be prepared in 3 different ways. They differ from each other by the way the desired tank temperature is set and how the unit acts upon it.

#	Code	Description
[5.6]	[6-0D]	Heat up mode: <ul style="list-style-type: none"> ▪ 0: Reheat only: Only reheat operation is allowed. ▪ 1: Schedule + reheat: The domestic hot water tank is heated according to a schedule and between the scheduled heat up cycles, reheat operation is allowed. ▪ 2: Schedule only: The domestic hot water tank can ONLY be heated according to a schedule.

See the operation manual for more details.



INFORMATION

Risk of space heating capacity shortage for domestic hot water tank without internal booster heater: In case of frequent domestic hot water operation, frequent and long space heating/cooling interruption will happen when selecting the following:

Tank > Heat up mode > Reheat only.

10.5.7 User settings

Language

#	Code	Description
[7.1]	N/A	Language

Time/date

#	Code	Description
[7.2]	N/A	Set the local time and date

**INFORMATION**

By default, daylight savings time is enabled and clock format is set to 24 hours. If you want to change these settings, you can do this in the menu structure (**User settings > Time/date**) once the unit is initialised.

Holiday**About holiday mode**

During your holiday, you can use the holiday mode to deviate from your normal schedules without having to change them. While holiday mode is active, space heating/cooling operation and domestic hot water operation will be turned off. Room frost protection and anti-legionella operation will remain active.

Typical workflow

Using holiday mode typically consists of the following stages:

- 1 Setting the starting date and ending date of your holiday.
- 2 Activating the holiday mode.

To check if holiday mode is activated and/or running

If  is displayed on the home screen, holiday mode is active.

To configure the holiday

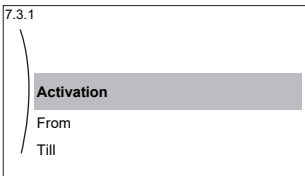
1	Activate the holiday mode.	—
	<ul style="list-style-type: none"> ▪ Go to [7.3.1]: User settings > Holiday > Activation. 	
	<ul style="list-style-type: none"> ▪ Select On. 	
2	Set the first day of your holiday.	—
	<ul style="list-style-type: none"> ▪ Go to [7.3.2]: From. 	
	<ul style="list-style-type: none"> ▪ Select a date. 	
	<ul style="list-style-type: none"> ▪ Confirm the changes. 	
3	Set the last day of your holiday.	—
	<ul style="list-style-type: none"> ▪ Go to [7.3.3]: Till. 	
	<ul style="list-style-type: none"> ▪ Select a date. 	
	<ul style="list-style-type: none"> ▪ Confirm the changes. 	

Quiet**About quiet mode**

You can use quiet mode to decrease the sound of the outdoor unit. However, this also decreases the heating/cooling capacity of the system. There are multiple quiet mode levels.

You can:

- Completely deactivate quiet mode
- Manually activate a quiet mode level until the next scheduled action
- Use and program a quiet mode schedule



INFORMATION

If the outdoor temperature is below zero, we recommend to NOT use the most quiet level.

To check if quiet mode is active

If is displayed on the home screen, quiet mode is active.

To use quiet mode

1	Go to [7.4.1]: User settings > Quiet > Activation.	
2	Do one of the following:	—

If you want to...	Then...	
Completely deactivate quiet mode	Select Off .	
Manually activate a quiet mode level	Select the applicable quiet mode level. Example: Most quiet.	
Use and program a quiet mode schedule	Select Automatic .	
	Go to [7.4.2] Schedule and program the schedule. For more information about scheduling, see " 10.3.7 Schedule screen: Example " ▶ 108].	

Electricity prices and gas price

Only applicable in combination with the bivalent function. See also "[Bivalent](#)" [▶](#) 161].

#	Code	Description
[7.5.1]	N/A	Electricity price > High
[7.5.2]	N/A	Electricity price > Medium
[7.5.3]	N/A	Electricity price > Low
[7.6]	N/A	Gas price



INFORMATION

Electricity price can only be set when bivalent is ON ([9.C.1] or [C-02]). These values can only be set in menu structure [7.5.1], [7.5.2] and [7.5.3]. Do NOT use overview settings.

To set the gas price

1	Go to [7.6]: User settings > Gas price.	
2	Select the correct gas price.	
3	Confirm the changes.	

**INFORMATION**

Price value ranging from 0.00~990 valuta/kWh (with 2 significant values).

To set the electricity price

1	Go to [7.5.1]/[7.5.2]/[7.5.3]: User settings > Electricity price > High/Medium/Low.	
2	Select the correct electricity price.	
3	Confirm the changes.	
4	Repeat this for all three electricity prices.	—

**INFORMATION**

Price value ranging from 0.00~990 valuta/kWh (with 2 significant values).

**INFORMATION**

If no schedule is set, the **Electricity price for High** is taken into account.

To set the electricity price schedule timer

1	Go to [7.5.4]: User settings > Electricity price > Schedule.	
2	Program the selection using the scheduling screen. You can set the High, Medium and Low electricity prices according to your electricity supplier.	—
3	Confirm the changes.	

**INFORMATION**

The values correspond with the electricity price values for **High, Medium** and **Low** previously set. If no schedule is set, the electricity price for **High** is taken into account.

About energy prices in case of an incentive per kWh renewable energy

An incentive can be taken into account when setting the energy prices. Although the running cost can increase, the total operation cost, taking into account the reimbursement will be optimized.

**NOTICE**

Make sure to modify the setting of the energy prices at the end of the incentive period.

To set the gas price in case of an incentive per kWh renewable energy

Calculate the value for the gas price with the following formula:

- Actual gas price+(Incentive/kWh×0.9)

For the procedure to set the gas price, see "[To set the gas price](#)" [▶ 145].

To set the electricity price in case of an incentive per kWh renewable energy

Calculate the value for the electricity price with following formula:

- Actual electricity price+Incentive/kWh

For the procedure to set the electricity price, see ["To set the electricity price"](#) [▶ 146].

Example

This is an example and the prices and/or values used in this example are NOT accurate.

Data	Price/kWh
Gas price	4.08
Electricity price	12.49
Renewable heat incentive per kWh	5

Calculation of the gas price

Gas price=Actual gas price+(Incentive/kWh×0.9)

Gas price=4.08+(5×0.9)

Gas price=8.58

Calculation of the electricity price

Electricity price=Actual electricity price+Incentive/kWh

Electricity price=12.49+5

Electricity price=17.49

Price	Value in breadcrumb
Gas: 4.08 /kWh	[7.6]=8.6
Electricity: 12.49 /kWh	[7.5.1]=17

10.5.8 Information

Dealer information

The installer can fill in his contact number here.

#	Code	Description
[8.3]	N/A	Number that users can call in case of problems.

Possible read-out information

In menu...	You can read out...
[8.1] Energy data	Produced energy, consumed electricity, and consumed gas
[8.2] Malfunction history	Malfunction history
[8.3] Dealer information	Contact/helpdesk number
[8.4] Sensors	Room, tank or domestic hot water, outside, and leaving water temperature (if applicable)
[8.5] Actuators	Status/mode of each actuator Example: Domestic hot water pump ON/OFF
[8.6] Operation modes	Current operation mode Example: Defrost/oil return mode

In menu...	You can read out...
[8.7] About	Version information about the system
[8.8] Connection status	Information about the connection status of the unit, the room thermostat and the LAN adapter.

10.5.9 Installer settings

Configuration wizard

After first power ON of the system, the user interface will guide you using the configuration wizard. This way you can set the most important initial settings. This way the unit will be able to run properly. Afterwards, more detailed settings can be done via the menu structure if required.

To restart the configuration wizard, go to **Installer settings > Configuration wizard** [9.1].

Domestic hot water

This part only applies to systems with an optional domestic hot water tank installed.

Domestic hot water

The following setting determines if the system can prepare domestic hot water or not, and which tank is used. Set this setting according to the actual installation.

#	Code	Description
[9.2.1]	[E-05] ^(a) [E-06] ^(a) [E-07] ^(a)	<ul style="list-style-type: none"> ▪ No DHW No tank installed. ▪ EKHWS/E Tank with booster heater installed at the side of the tank. ▪ EKHWP/HYC Tank with optional booster heater installed at the top of the tank.

^(a) Use the menu structure instead of the overview settings. Menu structure setting [9.2.1] replaces the following 3 overview settings:

- [E-05]: Can the system prepare domestic hot water?
- [E-06]: Is a domestic hot water tank installed in the system?
- [E-07]: What kind of domestic hot water tank is installed?

In case of EKHWP, we recommend to use the following settings:

#	Code	Item	EKHWP
[9.2.1]	[E-07]	Tank type	5: EKHWP/HYC
N/A	[4-05]	Thermistor type	0: Automatic
[5.8]	[6-0E]	Maximum tank temperature	≤70°C

In case of EKHWS*D* / EKHWSU*D*, we recommend to use the following settings:

#	Code	Item	EKHWS*D* / EKHWSU*D*	
			150/180	200/250/300
[9.2.1]	[E-07]	Tank type	0: EKHWS/E	5: EKHWP/HYC

#	Code	Item	EKHWS*D* / EKHWSU*D*	
			150/180	200/250/300
N/A	[4-05]	Thermistor type	0: Automatic	1: Type 1
[5.8]	[6-0E]	Maximum tank temperature	≤75°C	

In case of a third-party tank, we recommend to use the following settings:

#	Code	Item	Third-party tank	
			Coil≥1.05 m ²	Coil≥1.8 m ²
[9.2.1]	[E-07]	Tank type	0: EKHWS/E	5: EKHWP/HYC
N/A	[4-05]	Thermistor type	0: Automatic	1: Type 1
[5.8]	[6-0E]	Maximum tank temperature	≤75°C	

DHW pump

#	Code	Description
[9.2.2]	[D-02]	<p>DHW pump:</p> <ul style="list-style-type: none"> 0: No DHW pump: NOT installed 1: Instant hot water: Installed for instant hot water when water is tapped. The user sets the operation timing of the domestic hot water pump using the schedule. Control of this pump is possible with the user interface. 2: Disinfection: Installed for disinfection. It runs when the disinfection function of the domestic hot water tank is running. No further settings are needed. <p>See also illustrations below.</p>

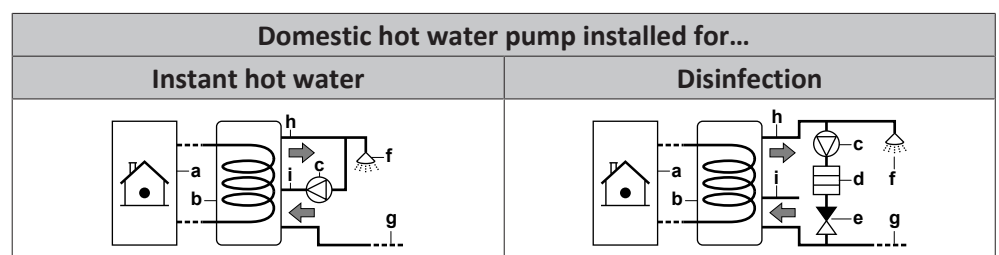

- a Indoor unit
- b Tank
- c Domestic hot water pump
- d Heater element
- e Non-return valve
- f Shower
- g Cold water
- h Domestic hot water OUT
- i Recirculation connection

DHW pump schedule

Program a schedule for the DHW pump **(only for field supplied domestic hot water pump for secondary return)**.

Program a domestic hot water pump schedule to determine when to turn on and off the pump.

When turned on, the pump runs and makes sure hot water is instantly available at the tap. To save energy, only turn on the pump during periods of the day when instant hot water is necessary.

Backup heater

Besides the type of backup heater, the voltage, configuration and capacity must be set on the user interface.

The capacities for the different steps of the backup heater must be set for the energy metering and/or power consumption feature to work properly. When measuring the resistance value of each heater, you can set the exact heater capacity and this will lead to more accurate energy data.

Backup heater type

The backup heater is adapted to be connected to most common European electricity grids. The type of backup heater must be set on the user interface. For units with a built-in backup heater, the type of heater can be viewed but not changed.

#	Code	Description
[9.3.1]	[E-03]	<ul style="list-style-type: none"> ▪ 3: 6V ▪ 4: 9W

Voltage

- For a 6V model, this can be set to:
 - 230V, 1ph
 - 230V, 3ph
- For a 9W model, this is fixed to 400V, 3ph.

#	Code	Description
[9.3.2]	[5-0D]	<ul style="list-style-type: none"> ▪ 0: 230V, 1ph ▪ 1: 230V, 3ph ▪ 2: 400V, 3ph

Configuration

The backup heater can be configured in different ways. It can be chosen to have a 1-step only backup heater or a backup heater with 2 steps. If 2 steps, the capacity of the second step depends on this setting. It can also be chosen to have a higher capacity of the second step in emergency.

#	Code	Description
[9.3.3]	[4-0A]	<ul style="list-style-type: none"> ▪ 1: Relay 1 / Relay 1+2 ▪ 2: Relay 1 / Relay 2 ▪ 3: Relay 1 / Relay 2 Emergency Relay 1+2



INFORMATION

Settings [9.3.3] and [9.3.5] are linked. Changing one setting influences the other. If you change one, check if the other is still as expected.



INFORMATION

During normal operation, the capacity of the second step of the backup heater at nominal voltage is equal to [6-03]+[6-04].

**INFORMATION**

If [4-0A]=3 and emergency mode is active, the power usage of the backup heater is maximal and equal to $2 \times [6-03] + [6-04]$.

**INFORMATION**

Only for systems with integrated domestic hot water tank: If the storage temperature setpoint is higher than 50°C, Daikin recommends NOT to disable the backup heater second step because it will have a big impact on the required time for the unit to heat up the domestic hot water tank.

Capacity step 1

#	Code	Description
[9.3.4]	[6-03]	<ul style="list-style-type: none"> The capacity of the first step of the backup heater at nominal voltage.

Additional capacity step 2

#	Code	Description
[9.3.5]	[6-04]	<ul style="list-style-type: none"> The capacity difference between the second and first step of the backup heater at nominal voltage. Nominal value depends on backup heater configuration.

Operation

#	Code	Description
[9.3.8]	[4-00]	Backup heater operation: <ul style="list-style-type: none"> 0: Restricted 1: Allowed 2: Only DHW: Backup heater operation is enabled for domestic hot water and disabled for space heating.

Booster heater**Capacity**

The capacity of the booster heater must be set for the energy metering and/or power consumption control feature to work properly. When measuring the resistance value of the booster heater, you can set the exact heater capacity and this will lead to more accurate energy data.

#	Code	Description
[9.4.1]	[6-02]	Capacity [kW]. Only applies to domestic hot water tank with an internal booster heater. The capacity of the booster heater at nominal voltage. Range: 0~10 kW

BSH allowance schedule

Program when the booster heater can operate. You can set a schedule for the booster heater here using the schedule screen. Two actions per day are allowed in a week schedule. For more information, see "[10.3.7 Schedule screen: Example](#)" [▶ 108].

Example: Only allow the booster heater to operate during the night.

BSH eco timer

#	Code	Description
[9.4.3]	[8-03]	<p>Booster heater delay timer.</p> <p>Start-up delay time for the booster heater when domestic hot water mode is active.</p> <ul style="list-style-type: none"> When domestic hot water mode is NOT active, the delay time is 20 minutes. The delay time starts from booster heater ON temperature. By adapting the booster heater delay time versus the maximum running time, you can find an optimal balance between the energy efficiency and the heat up time. If the booster heater delay time is set too high, it might take a long time before the domestic hot water reaches its set temperature. The setting [8-03] is only meaningful if setting [4-03]=1. Setting [4-03]=0/2/3/4 limits the booster heater automatically in relation to heat pump operation time in domestic water heating mode. Make sure that [8-03] is always in relation with the maximum running time [8-01]. <p>Range: 20~95 minutes</p>

Operation

#	Code	Description
[9.4.4]	[4-03]	<p>Defines the operation permission of the booster heater depending on ambient, domestic hot water temperature or operation mode of heat pump. This setting is only applicable in reheat mode for applications with separate domestic hot water tank. When setting [4-03]=1/2/3/4, the booster heater operation can still be restricted by the booster heater allowance schedule.</p>
[9.4.4]	[4-03]	<ul style="list-style-type: none"> 0 Restricted: Booster heater operation is NOT allowed except for "Disinfection function" and "Powerful domestic water heating". <p>Only use this in case the heat pump capacity can cover the heating requirements of the house and domestic hot water during the complete heating season.</p> <p>The booster heater will not be allowed to operate when $T_a < [5-03]$ and $[5-02]=1$. The domestic hot water temperature can be maximum the heat pump OFF temperature.</p>
[9.4.4]	[4-03]	<ul style="list-style-type: none"> 1 Allowed: Booster heater operation is allowed when required.

#	Code	Description
[9.4.4]	[4-03]	<ul style="list-style-type: none"> ▪ 2 Overlap: The booster heater is allowed outside the operation range of the heat pump for domestic hot water operation. Booster heater operation is only allowed if: <ul style="list-style-type: none"> - Ambient temperature is out of the operating range: $T_a < [5-03]$ or $T_a > 35^\circ\text{C}$ The booster heater is only allowed to operate when $T_a < [5-03]$ if space heating priority is enabled ($[5-02]=1$). <ul style="list-style-type: none"> - Domestic hot water temperature is 2°C lower than the heat pump OFF temperature. If bivalent operation is enabled ($[C-02]=1$) and permission signal for auxiliary boiler is ON, the booster heater will be restricted even when $T_a < [5-03]$.
9.4.4	[4-03]	<ul style="list-style-type: none"> ▪ 3 Compressor off: The booster heater is allowed when the heat pump is NOT active in domestic hot water operation. Same as setting 1, but simultaneous heat pump domestic hot water operation and booster heater operation is not allowed.
9.4.4	[4-03]	<ul style="list-style-type: none"> ▪ 4 Legionella only: Booster heater operation is NOT allowed except for "Disinfection function". Only use this in case the capacity of the heat pump can cover the heating requirements of the house and domestic hot water over the complete heating season. The booster heater will not be allowed to operate when $T_a < [5-03]$ and $[5-02]=1$. The domestic hot water temperature can be maximum the heat pump OFF temperature.

Emergency

Emergency

When the heat pump fails to operate, the backup heater and/or booster heater can serve as an emergency heater and take over the heat load either automatically or by manual interaction.

- When **Emergency** is set to **Automatic** and a heat pump failure occurs:
 - the backup heater automatically takes over the heat load,
 - the booster heater in the optional tank automatically takes over the domestic hot water production.
- When **Emergency** is set to **Manual** and a heat pump failure occurs, the domestic hot water operation and space heating stops.

To manually recover it via the user interface, go to the **Malfunctioning** main menu screen and confirm whether the backup heater and/or booster heater can take over the heat load or not.

We recommend to set **Emergency** to **Automatic** if the house is unattended for longer periods.

#	Code	Description
[9.5]	N/A	<ul style="list-style-type: none"> ▪ 0: Manual ▪ 1: Automatic



INFORMATION

The auto emergency setting can be set in the menu structure of the user interface only.



INFORMATION

If a heat pump failure occurs and **Emergency** is set to **Manual**, the room frost protection function, the underfloor heating screed dryout function, and the water pipe antifreeze function will remain active even if the user does NOT confirm emergency operation.

Glycol filled system

Glycol Filled system

This setting gives the installer the possibility to indicate whether the system is filled with glycol or water. This is important in case glycol is used to protect the water circuit against freezing. If NOT set correctly, the liquid in the piping can freeze.

#	Code	Description
N/A	[E-0D]	Glycol Filled system: Is the system filled with glycol? <ul style="list-style-type: none"> ▪ 0: No ▪ 1: Yes

Balancing

Priorities

For systems with a separate domestic hot water tank.

#	Code	Description
[9.6.1]	[5-02]	Space heating priority: Defines whether domestic hot water is made by booster heater only when outdoor temperature is below space heating priority temperature. <ul style="list-style-type: none"> ▪ 0: Off (default) ▪ 1: On Please do NOT change the default value. [5-01] Equilibrium temperature and [5-03] Space heating priority temperature are related to backup heater. So, you must set [5-03] equal or a few degrees higher than [5-01].

#	Code	Description
[9.6.2]	[5-03]	<p>Priority temperature: Defines the outdoor temperature which below the domestic hot water will be heated by booster heater only.</p> <p>Please do NOT change the default value.</p> <p>Range: $-15^{\circ}\text{C}\sim 35^{\circ}\text{C}$</p>
[9.6.3]	[5-04]	<p>Offset BSH setpoint: Setpoint correction for domestic hot water temperature: setpoint correction for the desired domestic hot water temperature, to be applied at low outdoor temperature when space heating priority is enabled. The corrected (higher) setpoint will make sure that the total heat capacity of the water in the tank remains approximately unchanged, by compensating for the colder bottom water layer of the tank (because the heat exchanger coil is not operational) with a warmer top layer.</p> <p>Range: $0^{\circ}\text{C}\sim 20^{\circ}\text{C}$</p>

Timers

For simultaneous space and domestic hot water operation request.

[8-02]: Anti-recycle timer

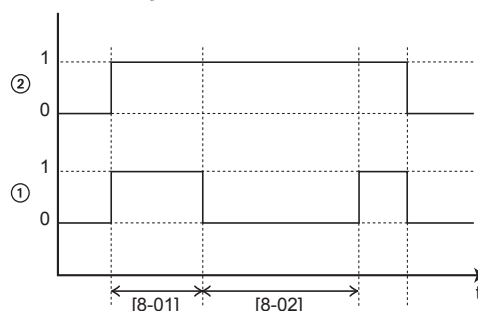

- 1 Heat pump domestic water heating mode (1=active, 0=not active)
- 2 Hot water request for heat pump (1=request, 0=no request)
- t Time

[8-04]: Additional timer at [4-02]/[F-01]

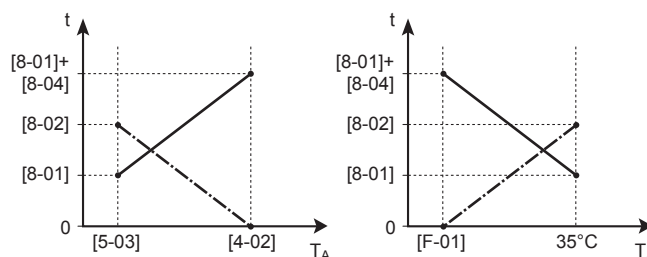

- T_A Ambient (outdoor) temperature
- t Time
- Anti-recycle timer
- Maximum running time domestic hot water

#	Code	Description
[9.6.4]	[8-02]	<p>Anti-recycle timer: Minimum time between two cycles for domestic hot water. The actual anti-recycling time also depends on setting [8-04].</p> <p>Range: 0~10 hours</p> <p>Remark: The minimum time is 0.5 hours even when the selected value is 0.</p>
[9.6.5]	[8-00]	<p>Minimum running timer:</p> <p>Do NOT change.</p>
[9.6.6]	[8-01]	<p>Maximum running timer for domestic hot water operation. Domestic hot water heating stops even when the target domestic hot water temperature is NOT reached. The actual maximum running time also depends on setting [8-04].</p> <ul style="list-style-type: none"> When Control=Room thermostat: This preset value is only taken into account if there is a request for space heating or cooling. If there is NO request for space heating/cooling, the tank is heated until the setpoint has been reached. When Control≠Room thermostat: This preset value is always taken into account. <p>Range: 5~95 minutes</p> <p>Remark: It is NOT allowed to set [8-01] to a value below 10 minutes.</p>
[9.6.7]	[8-04]	<p>Additional timer: Additional running time for the maximum running time depending on the outdoor temperature [4-02] or [F-01].</p> <p>Range: 0~95 minutes</p>

Water pipe freeze prevention

Only relevant for installations with water piping outdoors. This function tries to protect outdoor water piping from freezing.

#	Code	Description
[9.7]	[4-04]	<p>Water pipe freeze prevention:</p> <ul style="list-style-type: none"> 0: Continuous pump operation (read only)



NOTICE

Water pipe freeze prevention. Even if you turn OFF space heating/cooling operation ([C.2]: Operation > Space heating/cooling), water pipe freeze prevention –if enabled– will remain active.

Benefit kWh power supply

**INFORMATION**

The preferential kWh rate power supply contact is connected to the same terminals (X5M/9+10) as the safety thermostat. Thus, the system can have EITHER preferential kWh rate power supply OR a safety thermostat.

#	Code	Description
[9.8.1]	[D-01]	<p>Connection to a Benefit kWh power supply or a Safety thermostat:</p> <ul style="list-style-type: none"> ▪ 0 No: The outdoor unit is connected to a normal power supply. ▪ 1 Open: The outdoor unit is connected to a preferential kWh rate power supply. When the preferential kWh rate signal is sent by the electricity company, the contact will open and the unit will go in forced off mode. When the signal is released again, the voltage-free contact will close and the unit will restart operation. Therefore, always enable the auto restart function. ▪ 2 Closed: The outdoor unit is connected to a preferential kWh rate power supply. When the preferential kWh rate signal is sent by the electricity company, the contact will close and the unit will go in forced off mode. When the signal is released again, the voltage-free contact will open and the unit will restart operation. Therefore, always enable the auto restart function. ▪ 3 Safety thermostat: A safety thermostat is connected to the system (normal closed contact)
[9.8.2]	[D-00]	<p>Allow heater: Which heaters are allowed to operate during preferential kWh rate power supply?</p> <ul style="list-style-type: none"> ▪ 0 No: None ▪ 1 Only BSH: Booster heater only ▪ 2 Only BUH: Backup heater only ▪ 3 All: All heaters <p>See table below.</p> <p>Setting 2 is only meaningful if the preferential kWh rate power supply is of type 1 or indoor unit is connected to a normal kWh rate power supply (via X2M/5-6) and the backup heater is NOT connected to the preferential kWh rate power supply.</p>
[9.8.3]	[D-05]	<p>Allow pump:</p> <ul style="list-style-type: none"> ▪ 0 No: Pump is forced off ▪ 1 Yes: No limitation

Allowed heaters during preferential kWh rate power supply

[D-00]	Booster heater	Backup heater	Compressor
0	Forced OFF	Forced OFF	Forced OFF
1	Permitted		
2	Forced OFF	Permitted	
3	Permitted		

Power consumption control

Power consumption control

See "6 Application guidelines" [▶ 30] for detailed information about this functionality.

#	Code	Description
[9.9.1]	[4-08]	Power consumption control: <ul style="list-style-type: none"> ▪ 0 No: Disabled. ▪ 1 Continuous: Enabled: You can set one power limitation value (in A or kW) to which the system power consumption will be limited for all the time. ▪ 2 Inputs: Enabled: You can set up to four different power limitation values (in A or kW) to which the system power consumption will be limited when the corresponding digital input asks.
[9.9.2]	[4-09]	Type: <ul style="list-style-type: none"> ▪ 0 Amp: The limitation values are set in A. ▪ 1 kW: The limitation values are set in kW.

Limit when [9.9.1]=Continuous and [9.9.2]=Amp:

#	Code	Description
[9.9.3]	[5-05]	Limit: Only applicable in case of full time current limitation mode. 0 A~50 A

Limits when [9.9.1]=Inputs and [9.9.2]=Amp:

#	Code	Description
[9.9.4]	[5-05]	Limit 1: 0 A~50 A
[9.9.5]	[5-06]	Limit 2: 0 A~50 A
[9.9.6]	[5-07]	Limit 3: 0 A~50 A
[9.9.7]	[5-08]	Limit 4: 0 A~50 A

Limit when [9.9.1]=Continuous and [9.9.2]=kW:

#	Code	Description
[9.9.8]	[5-09]	Limit: Only applicable in case of full time power limitation mode. 0 kW~20 kW

Limits when [9.9.1]=Inputs and [9.9.2]=kW:

#	Code	Description
[9.9.9]	[5-09]	Limit 1: 0 kW~20 kW
[9.9.A]	[5-0A]	Limit 2: 0 kW~20 kW
[9.9.B]	[5-0B]	Limit 3: 0 kW~20 kW
[9.9.C]	[5-0C]	Limit 4: 0 kW~20 kW

Priority heater

#	Code	Description
[9.9.D]	[4-01]	<p>Power consumption control DISABLED [4-08]=0</p> <ul style="list-style-type: none"> ▪ 0 None : Backup heater and booster heater can operate simultaneously. ▪ 1 Booster heater: The booster heater is prioritised. ▪ 2 Backup heater: The backup heater is prioritised. <p>Power consumption control ENABLED [4-08]=1/2</p> <ul style="list-style-type: none"> ▪ 0 None : Depending on the power limitation level, the booster heater will be limited first, before the backup heater is limited. ▪ 1 Booster heater: Depending on the power limitation level, the backup heater will be limited first, before the booster heater is limited. ▪ 2 Backup heater: Depending on the power limitation level, the booster heater will be limited first, before the backup heater is limited.

Note: In case power consumption control is DISABLED (for all models) the setting [4-01] defines whether backup heater and booster heater can operate simultaneously, or if the booster heater/backup heater has priority over the backup heater/booster heater.

In case power consumption control is ENABLED, the setting [4-01] defines the priority of the electrical heaters depending on applicable limitation.

Energy metering

Energy metering

If energy metering is performed by the use of external power meters, configure the settings as described below. Select the pulse frequency output of each power meter in accordance with the power meter specifications. It is possible to connect up to 2 power meters with different pulse frequencies. If only 1 or no power meter is used, select 'None' to indicate the corresponding pulse input is NOT used.

#	Code	Description
[9.A.1]	[D-08]	Electricity meter 1: <ul style="list-style-type: none"> ▪ 0 None: NOT installed ▪ 1 1/10kWh: Installed ▪ 2 1/kWh: Installed ▪ 3 10/kWh: Installed ▪ 4 100/kWh: Installed ▪ 5 1000/kWh: Installed
[9.A.2]	[D-09]	Electricity meter 2: <ul style="list-style-type: none"> ▪ 0 None: NOT installed ▪ 1 1/10kWh: Installed ▪ 2 1/kWh: Installed ▪ 3 10/kWh: Installed ▪ 4 100/kWh: Installed ▪ 5 1000/kWh: Installed

Sensors

External sensor

#	Code	Description
[9.B.1]	[C-08]	External sensor: When an optional external ambient sensor is connected, the type of the sensor must be set. <ul style="list-style-type: none"> ▪ 0 None : NOT installed. The thermistor in the user interface and in the outdoor unit are used for measurement. ▪ 1 Outdoor: Connected to PCB of the indoor unit measuring the outdoor temperature. Remark: For some functionality, the temperature sensor in the outdoor unit is still used. ▪ 2 Room: Connected to PCB of the indoor unit measuring the indoor temperature. The temperature sensor in the user interface is NOT used anymore. Remark: This value has only meaning in room thermostat control.

Ext. amb. sensor offset

ONLY applicable in case an external outdoor ambient sensor is connected and configured.

You can calibrate the external outdoor ambient temperature sensor. It is possible to give an offset to the thermistor value. This setting can be used to compensate for situations where the external outdoor ambient sensor cannot be installed on the ideal installation location.

#	Code	Description
[9.B.2]	[2-0B]	Ext. amb. sensor offset: Offset on the ambient temperature measured on the external outdoor temperature sensor. <ul style="list-style-type: none"> ▪ $-5^{\circ}\text{C}\sim 5^{\circ}\text{C}$, step 0.5°C

Averaging time

The average timer corrects the influence of ambient temperature variations. The weather-dependent setpoint calculation is done on the average outdoor temperature.

The outdoor temperature is averaged over the selected time period.

#	Code	Description
[9.B.3]	[1-0A]	Averaging time: <ul style="list-style-type: none"> ▪ 0: No averaging ▪ 1: 12 hours ▪ 2: 24 hours ▪ 3: 48 hours ▪ 4: 72 hours

Bivalent

Bivalent

Only applicable in case of auxiliary boiler.



NOTICE

Bivalent operation is only possible if:

- Space heating is turned ON, and
- DHW tank operation is turned OFF.



INFORMATION

Bivalent is only possible in case of 1 leaving water temperature zone with:

- room thermostat control, OR
- external room thermostat control.

About bivalent

The purpose of this function is to determine which heating source can/will provide the space heating, either the heat pump system or the auxiliary boiler.

#	Code	Description
[9.C.1]	[C-02]	Bivalent: Indicates if the space heating is also performed by means of another heat source than the system. <ul style="list-style-type: none"> ▪ 0 No: Not installed ▪ 1 Yes: Installed. The auxiliary boiler (gas boiler, oil burner) will operate when the outdoor ambient temperature is low. During bivalent operation, the heat pump is turned off. Set this value in case an auxiliary boiler is used.

- If **Bivalent** is enabled: When the outdoor temperature drops below the bivalent ON temperature (fixed or variable based on energy prices), the space heating by the heat pump stops automatically and the permission signal for the auxiliary boiler is active.
- If **Bivalent** is disabled: Space heating is only done by the heat pump within the operation range. The permission signal for the auxiliary boiler is always inactive.

The switch-over between the heat pump system and the auxiliary boiler is based on the following settings:

- [C-03] and [C-04]
- Electricity and gas prices ([7.5.1], [7.5.2], [7.5.3], and [7.6])

[C-03], [C-04], and T_{calc}

Based on the settings above, the heat pump system calculates a value T_{calc} , which is variable between [C-03] and [C-03]+[C-04].

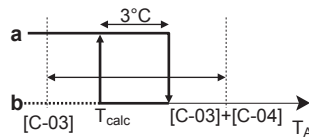

- T_A Outdoor temperature
- T_{calc} Bivalent ON temperature (variable). Below this temperature, the auxiliary boiler will always be ON. T_{calc} can never go below [C-03] or above [C-03]+[C-04].
- 3°C** Fixed hysteresis to prevent too much switching between heat pump system and auxiliary boiler
- a** Auxiliary boiler active
- b** Auxiliary boiler inactive

If the outdoor temperature...	Then...	
	Space heating by the heat pump system...	Bivalent signal for the auxiliary boiler is...
Drops below T_{calc}	Stops	Active
Rises above $T_{calc}+3^{\circ}\text{C}$	Starts	Inactive



INFORMATION

The permission signal for the auxiliary boiler is located on the EKR1HBAA (digital I/O PCB). When it is activated, the contact X1, X2 is closed and open when it is deactivated. See illustration below for the schematic location of this contact.

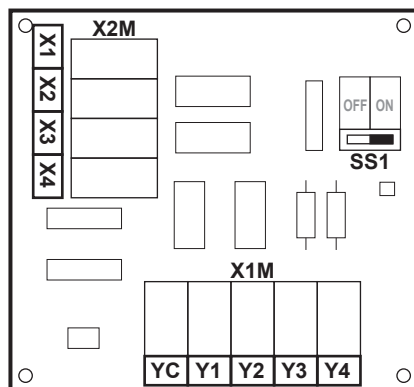

#	Code	Description
9.C.3	[C-03]	Range: $-25^{\circ}\text{C}\sim 25^{\circ}\text{C}$ (step: 1°C)

#	Code	Description
9.C.4	[C-04]	Range: 2°C~10°C (step: 1°C) The higher the value of [C-04], the higher the accuracy of the switch-over between the heat pump system and the auxiliary boiler.

To determine the value of [C-03], proceed as follows:

- 1 Determine the COP (= coefficient of performance) using the formula:

Formula	Example
$\text{COP} = (\text{Electricity price} / \text{gas price})^{(a)} \times \text{boiler efficiency}$	If: <ul style="list-style-type: none"> ▪ Electricity price: 20 c€/kWh ▪ Gas price: 6 c€/kWh ▪ Boiler efficiency: 0.9 Then: $\text{COP} = (20/6) \times 0.9 = 3$

^(a) Make sure to use the same units of measurement for the electricity price and gas price (example: both c€/kWh).

- 2 Determine the value of [C-03] using the graph. For an example, see the table legend.

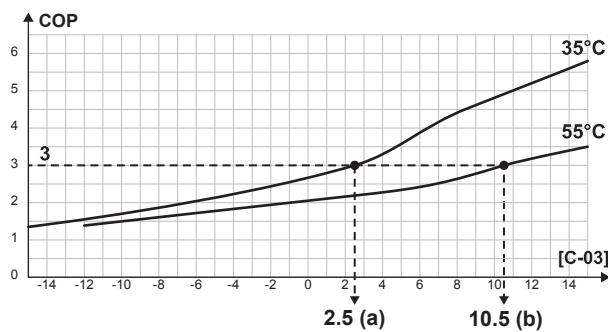

- a [C-03]=2.5 in case of COP=3 and LWT=35°C
- b [C-03]=10.5 in case of COP=3 and LWT=55°C



NOTICE

Make sure to set the value of [5-01] at least 1°C higher than the value of [C-03].

Electricity and gas prices



INFORMATION

To set electricity and gas price values, do NOT use overview settings. Set them in the menu structure instead ([7.5.1], [7.5.2], [7.5.3], and [7.6]). For more information on how to set the energy prices, see the operation manual and the user reference guide.



INFORMATION

Solar panels. If solar panels are used, set the electricity price value very low to promote the use of the heat pump.

#	Code	Description
[7.5.1]	N/A	User settings > Electricity price > High

#	Code	Description
[7.5.2]	N/A	User settings > Electricity price > Medium
[7.5.3]	N/A	User settings > Electricity price > Low
[7.6]	N/A	User settings > Gas price

Boiler efficiency

Depending on the used boiler, this should be chosen as follows:

#	Code	Description
[9.C.2]	[7-05]	<ul style="list-style-type: none"> ▪ 0: Very high ▪ 1: High ▪ 2: Medium ▪ 3: Low ▪ 4: Very low

Alarm output

Alarm output

#	Code	Description
[9.D]	[C-09]	<p>Alarm output: Indicates the logic of alarm output on digital I/O PCB during high level indoor unit error malfunctioning. Low level errors (caution/warning) will NOT be transmitted to alarm output.</p> <ul style="list-style-type: none"> ▪ 0 Abnormal: The alarm output will be powered when an alarm occurs. By setting this value, a distinction is made between the detection of an alarm, and the detection of a power failure. ▪ 1 Normal: The alarm output will NOT be powered when an alarm occurs. <p>See also table below (Alarm output logic).</p>

Alarm output logic

[C-09]	Alarm	No alarm	No power supply to unit
0	Closed output	Open output	Open output
1	Open output	Closed output	

Auto restart

Auto restart

When power returns after a power supply failure, the auto restart function reapplies the user interface settings at the time of the power failure. Therefore, it is recommended to always enable the function.

If the preferential kWh rate power supply is of the type that power supply is interrupted, always enable the auto restart function. Continuous indoor unit control can be guaranteed independent of the preferential kWh rate power supply status, by connecting the indoor unit to a separate normal kWh rate power supply.

#	Code	Description
[9.E]	[3-00]	Auto restart: <ul style="list-style-type: none"> ▪ 0: Manual ▪ 1: Automatic

Power saving function

Power saving function

Defines whether the outdoor unit power supply can be interrupted (internally by indoor unit control) during stand-still conditions (no space heating/cooling nor domestic hot water demand). The final decision to allow power interruption of the outdoor unit during standstill depends on the ambient temperature, compressor conditions and minimum internal timers.

To enable the power saving function setting, [E-08] needs to be enabled on the user interface.

#	Code	Description
[9.F]	[E-08]	Power saving function for outdoor unit: <ul style="list-style-type: none"> ▪ 0: No ▪ 1: Yes

Disable protections



INFORMATION

Protective functions – "Installer-on-site mode". The software is equipped with protective functions, such as room antifrost. The unit automatically runs these functions when necessary.

During installation or service this behaviour is undesired. Therefore, the protective functions can be disabled:

- **At first power-on:** The protective functions are disabled by default. After 12 hours they will be automatically enabled.
- **Afterwards:** An installer can manually disable the protective functions by setting [9.G]: **Disable protections=Yes**. After his work is done, he can enable the protective functions by setting [9.G]: **Disable protections=No**.

#	Code	Description
[9.G]	N/A	Disable protections: <ul style="list-style-type: none"> ▪ 0: No ▪ 1: Yes

Forced defrost

Forced defrost

Manually start a defrost operation.

#	Code	Description
[9.H]	N/A	Do you want to start a defrost operation? <ul style="list-style-type: none"> ▪ Back ▪ OK

**NOTICE**

Forced defrost start-up. You can only start forced defrost when the heating operation has been running for a while.

Overview field settings

Almost all settings can be done using the menu structure. If for any reason it is required to change a setting using the overview settings, then the overview settings can be accessed in the field settings overview [9.I]. See ["To modify an overview setting" \[▶ 101\]](#).

10.5.10 Commissioning

About commissioning

See: ["11 Commissioning" \[▶ 169\]](#)

10.5.11 User profile

[B] **User profile:** See ["To change the user permission level" \[▶ 100\]](#).

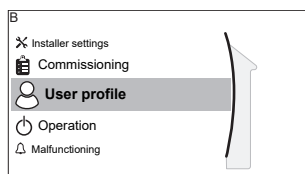

10.5.12 Operation

To enable or disable functionalities

In the operation menu, you can separately enable or disable functionalities of the unit.

#	Code	Description
[C.1]	N/A	Room: <ul style="list-style-type: none"> ▪ 0: Off ▪ 1: On
[C.2]	N/A	Space heating/cooling: <ul style="list-style-type: none"> ▪ 0: Off ▪ 1: On
[C.3]	N/A	Tank: <ul style="list-style-type: none"> ▪ 0: Off ▪ 1: On

10.6 Menu structure: Overview user settings

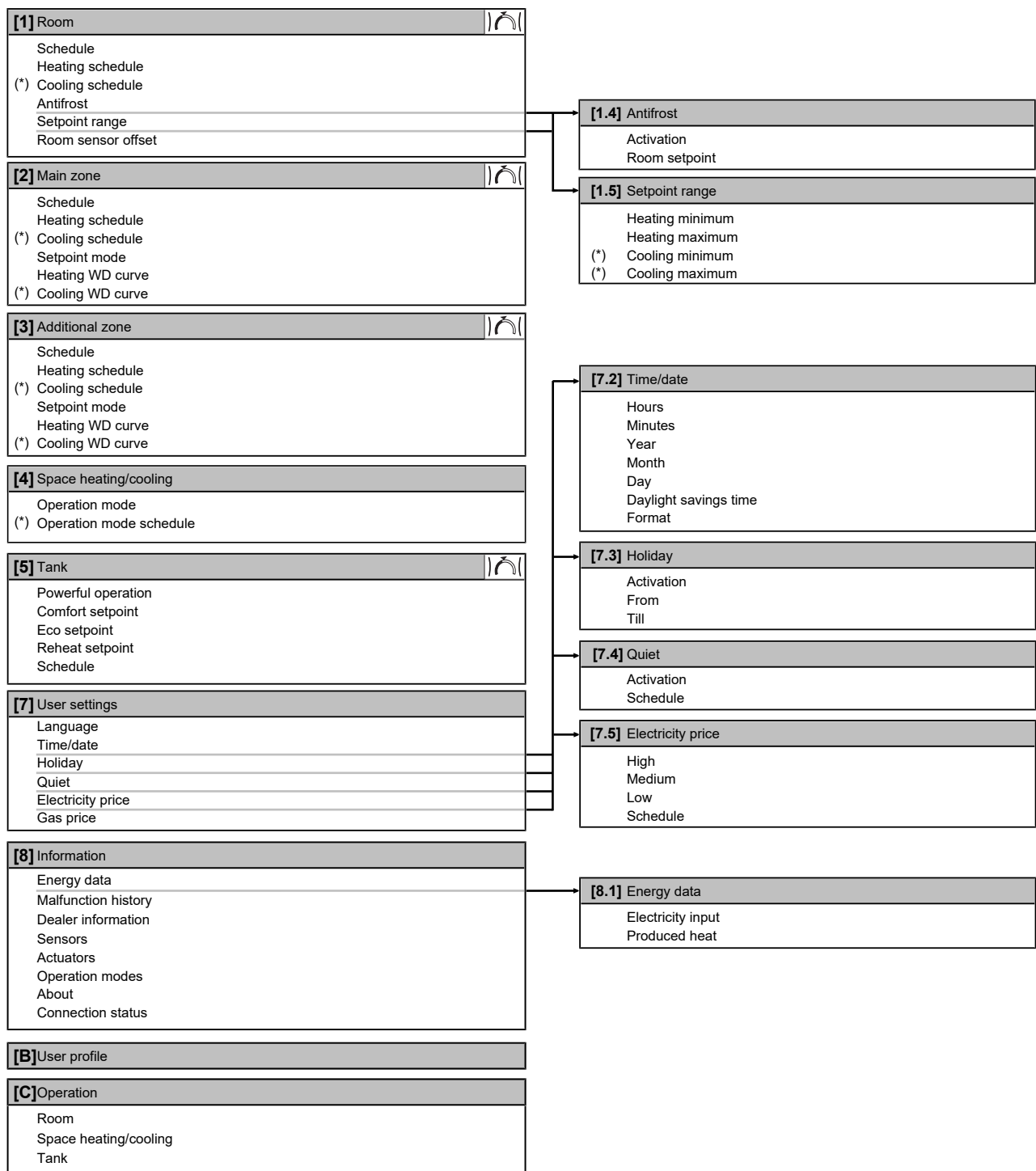

Setpoint screen

(*) Only applicable for reversible models, or heating only models + conversion kit



INFORMATION

Depending on the selected installer settings and unit type, settings will be visible/invisible.

10.7 Menu structure: Overview installer settings

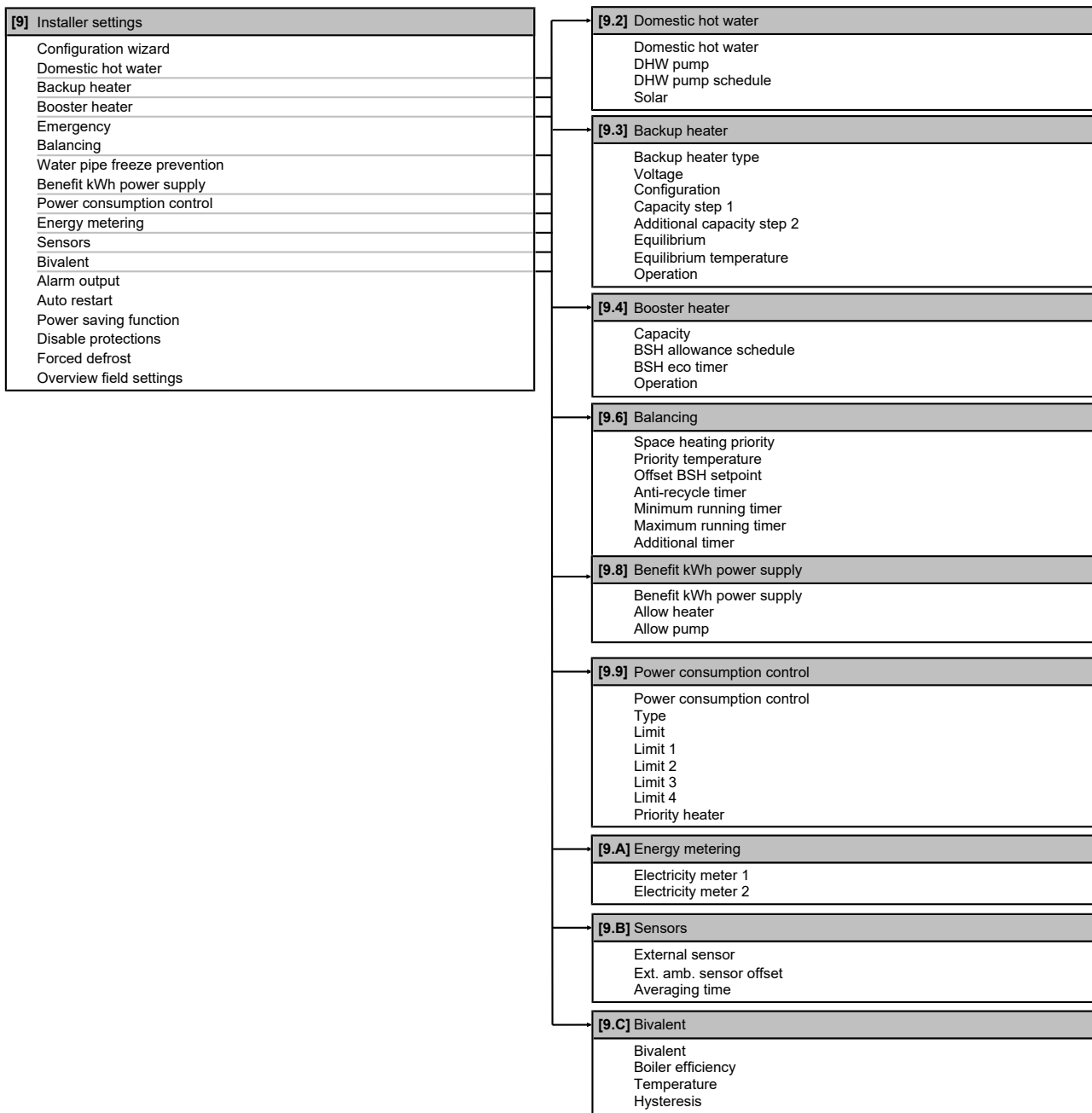

INFORMATION

Solar kit settings are shown but are NOT applicable for this unit. Settings shall NOT be used or changed.



INFORMATION

Depending on the selected installer settings and unit type, settings will be visible/invisible.

11 Commissioning



NOTICE

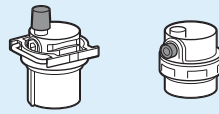

Make sure both air purge valves (one on the magnetic filter and one on the backup heater) are open.

All automatic air purge valves **MUST** remain open after commissioning.



INFORMATION

Protective functions – "Installer-on-site mode". The software is equipped with protective functions, such as room antifrost. The unit automatically runs these functions when necessary.

During installation or service this behaviour is undesired. Therefore, the protective functions can be disabled:

- **At first power-on:** The protective functions are disabled by default. After 12 hours they will be automatically enabled.
- **Afterwards:** An installer can manually disable the protective functions by setting [9.G]: **Disable protections=Yes**. After his work is done, he can enable the protective functions by setting [9.G]: **Disable protections=No**.

11.1 Overview: Commissioning

This chapter describes what you have to do and know to commission the system after it is installed and configured.

Typical workflow

Commissioning typically consists of the following stages:

- 1 Checking the "Checklist before commissioning".
- 2 Performing an air purge.
- 3 Performing a test run for the system.
- 4 If necessary, performing a test run for one or more actuators.
- 5 If necessary, performing an underfloor heating screed dryout.

11.2 Precautions when commissioning



INFORMATION

During the first running period of the unit, the required power may be higher than stated on the nameplate of the unit. This phenomenon is caused by the compressor, that needs a continuous run time of 50 hours before reaching smooth operation and stable power consumption.



NOTICE

ALWAYS operate the unit with thermistors and/or pressure sensors/switches. If **NOT**, burning of the compressor might be the result.

**NOTICE**

ALWAYS complete the refrigerant piping of the unit before operating. If NOT, the compressor will break.

11.3 Checklist before commissioning

After the installation of the unit, first check the items listed below. Once all checks are fulfilled, the unit **MUST** be closed. Power-up the unit after it is closed.

<input type="checkbox"/>	You read the complete installation instructions, as described in the installer reference guide .
<input type="checkbox"/>	The indoor unit is properly mounted.
<input type="checkbox"/>	The outdoor unit is properly mounted.
<input type="checkbox"/>	The following field wiring has been carried out according to this document and the applicable legislation: <ul style="list-style-type: none"> ▪ Between the local supply panel and the outdoor unit ▪ Between indoor unit and outdoor unit ▪ Between the local supply panel and the indoor unit ▪ Between the indoor unit and the valves (if applicable) ▪ Between the indoor unit and the room thermostat (if applicable) ▪ Between the indoor unit and the domestic hot water tank (if applicable)
<input type="checkbox"/>	The system is properly earthed and the earth terminals are tightened.
<input type="checkbox"/>	The fuses or locally installed protection devices are installed according to this document, and have NOT been bypassed.
<input type="checkbox"/>	The power supply voltage matches the voltage on the identification label of the unit.
<input type="checkbox"/>	There are NO loose connections or damaged electrical components in the switch box.
<input type="checkbox"/>	There are NO damaged components or squeezed pipes on the inside of the indoor and outdoor units.
<input type="checkbox"/>	Backup heater circuit breaker F1B (field supply) is turned ON.
<input type="checkbox"/>	Only for tanks with built-in booster heater: Booster heater circuit breaker F2B (field supply) is turned ON.
<input type="checkbox"/>	The correct pipe size is installed and the pipes are properly insulated.
<input type="checkbox"/>	There is NO water leak inside the indoor unit.
<input type="checkbox"/>	The shut-off valves are properly installed and fully open.
<input type="checkbox"/>	The automatic air purge valves are open.
<input type="checkbox"/>	The pressure relief valve purges water when opened. Clean water MUST come out.
<input type="checkbox"/>	The minimum water volume is guaranteed in all conditions. See "To check the water volume and flow rate" in " 8.1 Preparing water piping " ▶ 70].
<input type="checkbox"/>	(if applicable) The domestic hot water tank is filled completely.

11.4 Checklist during commissioning

<input type="checkbox"/>	The minimum flow rate during backup heater/defrost operation is guaranteed in all conditions. See "To check the water volume and flow rate" in " 8.1 Preparing water piping " [▶ 70].
<input type="checkbox"/>	To perform an air purge .
<input type="checkbox"/>	To perform a test run .
<input type="checkbox"/>	To perform an actuator test run .
<input type="checkbox"/>	Underfloor screed dryout function The underfloor screed dryout function is started (if necessary).

11.4.1 To check the minimum flow rate

1	Check the hydraulic configuration to find out which space heating loops can be closed by mechanical, electronic, or other valves.	—
2	Close all space heating loops that can be closed.	—
3	Start the pump test run (see " 11.4.4 To perform an actuator test run " [▶ 173]).	—
4	Read out the flow rate ^(a) and modify the bypass valve setting to reach the minimum required flow rate + 2 l/min.	—

^(a) During pump test run, the unit can operate below the minimum required flow rate.

Minimum required flow rate
20 l/min

11.4.2 Air purge function

Purpose

When commissioning and installing the unit, it is very important to remove all air in the water circuit. When the air purge function is running, the pump operates without actual operation of the unit and the removal of air in the water circuit will start.



NOTICE

Before starting the air purge, open the safety valve and check if the circuit is sufficiently filled with water. Only if water escapes the valve after opening it, you can start the air purge procedure.

Manual or automatic

There are 2 modes for purging air:

- **Manual:** You can set the pump speed to low or high. You can set the circuit (the position of the 3-way valve) to Space or Tank. Air purge must be performed for both space heating and tank (domestic hot water) circuits.
- **Automatic:** The unit automatically changes the pump speed and switches the position of the 3-way valve between the space heating and the domestic hot water circuit.

Typical workflow

Purging the air from the system should consist of:

- 1 Performing a manual air purge
- 2 Performing an automatic air purge

i

INFORMATION

Start by performing a manual air purge. When almost all the air is removed, perform an automatic air purge. If necessary, repeat performing the automatic air purge until you are sure that all air is removed from the system. During air purge function, pump speed limitation [9-0D] is NOT applicable.

The air purge function automatically stops after 30 minutes.

i

INFORMATION

For best results, air purge each loop separately.

To perform a manual air purge





Conditions: Make sure all operation is disabled. Go to [C]: **Operation** and turn off **Room, Space heating/cooling** and **Tank** operation.

1	Set the user permission level to Installer . See " To change the user permission level " [▶ 100].	—
2	Go to [A.3]: Commissioning > Air purge .	
3	In the menu, set Type = Manual .	
4	Select Start air purge .	
5	Select OK to confirm. Result: The air purge starts. It stops automatically when ready.	
6	During manual operation: <ul style="list-style-type: none"> ▪ You can change the pump speed. ▪ You must change the circuit. To change these settings during the air purge, open the menu and go to [A.3.1.5]: Settings . <ul style="list-style-type: none"> ▪ Scroll to Circuit and set it to Space/Tank. ▪ Scroll to Pump speed and set it to Low/High. 	
7	To stop the air purge manually:	—
1	Open the menu and go to Stop air purge .	
2	Select OK to confirm.	

To perform an automatic air purge





Conditions: Make sure all operation is disabled. Go to [C]: **Operation** and turn off **Room, Space heating/cooling** and **Tank** operation.

1	Set the user permission level to Installer . See " To change the user permission level " [▶ 100].	—
2	Go to [A.3]: Commissioning > Air purge .	

3	In the menu, set Type = Automatic .	
4	Select Start air purge .	
5	Select OK to confirm. Result: The air purge starts. It stops automatically when done.	
6	To stop the air purge manually:	—
	1 In the menu, go to Stop air purge .	
	2 Select OK to confirm.	

11.4.3 To perform an operation test run

Conditions: Make sure all operation is disabled. Go to [C]: **Operation** and turn off **Room, Space heating/cooling** and **Tank** operation.

1	Set the user permission level to Installer . See " To change the user permission level " [▶ 100].	—
2	Go to [A.1]: Commissioning > Operation test run .	
3	Select a test from the list. Example: Heating .	
4	Select OK to confirm. Result: The test run starts. It stops automatically when ready (± 30 min).	
	To stop the test run manually:	—
	1 In the menu, go to Stop test run .	
2	Select OK to confirm.	





INFORMATION

If the outdoor temperature is outside the range of operation, the unit may NOT operate or may NOT deliver the required capacity.

To monitor leaving water and tank temperatures

During test run, the correct operation of the unit can be checked by monitoring its leaving water temperature (heating/cooling mode) and tank temperature (domestic hot water mode).

To monitor the temperatures:

1	In the menu, go to Sensors .	
2	Select the temperature information.	





11.4.4 To perform an actuator test run

Conditions: Make sure all operation is disabled. Go to [C]: **Operation** and turn off **Room, Space heating/cooling** and **Tank** operation.

Purpose

Perform an actuator test run to confirm the operation of the different actuators. For example, when you select **Pump**, a test run of the pump will start.

1	Set the user permission level to Installer . See " To change the user permission level " [▶ 100].	—
----------	--	---

2	Go to [A.2]: Commissioning > Actuator test run.	
3	Select a test from the list. Example: Pump.	
4	Select OK to confirm. Result: The actuator test run starts. It stops automatically when ready (± 30 min).	
	To stop the test run manually:	—
1	In the menu, go to Stop test run.	
2	Select OK to confirm.	

11.4.5 Possible actuator test runs

- **Booster heater** test
- **Backup heater 1** test
- **Backup heater 2** test
- **Pump** test



INFORMATION

Make sure that all air is purged before executing the test run. Also avoid disturbances in the water circuit during the test run.

- **Shut off valve** test
- **Diverter valve** test (3-way valve for switching between space heating and tank heating)
- **Bivalent signal** test
- **Alarm output** test
- **C/H signal** test
- **DHW pump** test

11.4.6 Underfloor heating screed dryout

The underfloor heating (UFH) screed dryout function is used for drying out the screed of an underfloor heating system during the construction of the building.

Conditions: Make sure all operation is disabled. Go to [C]: **Operation** and turn off **Room, Space heating/cooling** and **Tank** operation.

The UFH screed dryout function can be executed without finishing the outdoor installation. In this case, the backup heater will perform the screed dryout and supply the leaving water without heat pump operation.

If the outdoor unit is not yet installed, connect the main power supply cable to the indoor unit via X2M/30 and X2M/31. See "[9.3.1 To connect the main power supply](#)" [▶ 89].



INFORMATION

- If **Emergency** is set to **Manual** ([9.5]=0), and the unit is triggered to start emergency operation, the user interface will ask confirmation before starting. The underfloor heating screed dryout function is active even if the user does NOT confirm emergency operation.
- During underfloor heating screed dryout, pump speed limitation [9-0D] is NOT applicable.



NOTICE

The installer is responsible for:

- contacting the screed manufacturer for the maximum allowed water temperature, to avoid cracking the screed,
- programming the underfloor heating screed dryout schedule according to the initial heating instructions of the screed manufacturer,
- checking the proper functioning of the setup on a regular basis,
- performing the correct program complying with the type of the used screed.



NOTICE

To perform an underfloor heating screed dryout, room frost protection needs to be disabled ([2-06]=0). By default, it is enabled ([2-06]=1). However, due to the "installer-on-site" mode (see "Commissioning"), room frost protection will be automatically disabled for 12 hours after the first power-on.

If the screed dryout still needs to be performed after the first 12 hours of power-on, manually disable room frost protection by setting [2-06] to "0", and KEEP it disabled until the screed dryout has finished. Ignoring this notice will result in cracking of the screed.



NOTICE

For the underfloor heating screed dryout to be able to start, make sure the following settings are met:

- [4-00]=1
- [C-02]=0
- [D-01]=0
- [4-08]=0
- [4-01]≠1

The installer can program up to 20 steps. For each step he needs to enter:

- 1 the duration in hours, up to 72 hours,
- 2 the desired leaving water temperature, up to 55°C.

Example:

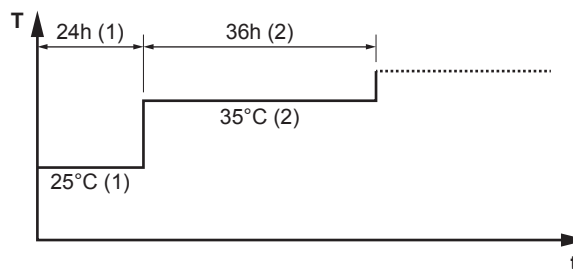

- T** Desired leaving water temperature (15~55°C)
- t** Duration (1~72 h)
- (1)** Action step 1
- (2)** Action step 2

To program an underfloor heating screed dryout schedule

1	Set the user permission level to Installer . See "To change the user permission level" [▶ 100].	—
2	Go to [A.4.2]: Commissioning > UFH screed dryout > Program .	🔍⋮○

3	Program the schedule: To add a new step, select an empty line and change its value. To delete a step and all steps below it, decrease the duration to "_".	—
	▪ Scroll through the schedule.	
	▪ Adjust the duration (between 1 and 72 hours) and temperatures (between 15°C and 55°C).	
4	Press the left dial to save the schedule.	

To perform an underfloor heating screed dryout

Conditions: An underfloor heating screed dryout schedule has been programmed. See ["To program an underfloor heating screed dryout schedule"](#) [▶ 175].

Conditions: Make sure all operation is disabled. Go to [C]: **Operation** and turn off Room, Space heating/cooling and Tank operation.

1	Set the user permission level to Installer . See "To change the user permission level" [▶ 100].	—
2	Go to [A.4]: Commissioning > UFH screed dryout .	
3	Select Start UFH screed dryout .	
4	Select OK to confirm. Result: The underfloor heating screed dryout starts. It stops automatically when done.	
5	To stop the underfloor heating screed dryout manually:	—
	1 Open the menu and go to Stop UFH screed dryout .	
	2 Select OK to confirm.	

To read out the status of an underfloor heating screed dryout

Conditions: You are performing an underfloor heating screed dryout.

1	Press the back button. Result: A graph is displayed, highlighting the current step of the screed dryout schedule, the total remaining time, and the current desired leaving water temperature.	
2	Press the left dial to open the menu structure and to:	
	1 View the status of sensors and actuators.	—
	2 Adjust the current program	—



To stop an underfloor heating (UFH) screed dryout

U3-error

When the program is stopped by an error, an operation switch off, or a power failure, the U3 error will be displayed on the user interface. To resolve the error codes, see ["14.4 Solving problems based on error codes"](#) [▶ 191].

Stop UFH screed dryout

To manually stop underfloor heating screed dryout:

1	Go to [A.4.3]: Commissioning > UFH screed dryout	—
2	Select Stop UFH screed dryout .	
3	Select OK to confirm. Result: The underfloor heating screed dryout is stopped.	

Read out UFH screed dryout status

When the program is stopped due to an error, an operation switch-off, or a power failure, you can read out the underfloor heating screed dryout status:

1	Go to [A.4.3]: Commissioning > UFH screed dryout > Status	
2	You can read out the value here: Stopped at + the step where the underfloor screed dryout was stopped.	—
3	Modify and restart the execution of the program ^(a) .	—

^(a) If the UFH screed dryout program was stopped due to a power failure and the power resumes, the program will automatically restart the last implemented step.

12 Hand-over to the user

Once the test run is finished and the unit operates properly, please make sure the following is clear for the user:

- Fill in the installer setting table (in the operation manual) with the actual settings.
- Make sure that the user has the printed documentation and ask him/her to keep it for future reference. Inform the user that he can find the complete documentation at the URL mentioned earlier in this manual.
- Explain the user how to properly operate the system and what to do in case of problems.
- Show the user what to do for the maintenance of the unit.
- Explain the user about energy saving tips as described in the operation manual.

13 Maintenance and service



NOTICE

Maintenance **MUST** be done by an authorised installer or service agent.

We recommend performing maintenance at least once a year. However, applicable legislation might require shorter maintenance intervals.



NOTICE

Applicable legislation on **fluorinated greenhouse gases** requires that the refrigerant charge of the unit is indicated both in weight and CO₂ equivalent.

Formula to calculate the quantity in CO₂ equivalent tonnes: GWP value of the refrigerant × total refrigerant charge [in kg] / 1000

13.1 Overview: Maintenance and service

This chapter contains information about:

- The yearly maintenance of the outdoor unit
- The yearly maintenance of the indoor unit

13.2 Maintenance safety precautions



DANGER: RISK OF ELECTROCUTION



DANGER: RISK OF BURNING/SCALDING



NOTICE: Risk of electrostatic discharge

Before performing any maintenance or service work, touch a metal part of the unit in order to eliminate static electricity and to protect the PCB.

13.3 Checklist for yearly maintenance of the outdoor unit

Check the following at least once a year:

- Heat exchanger

The heat exchanger of the outdoor unit can get blocked up due to dust, dirt, leaves, etc. It is recommended to clean the heat exchanger yearly. A blocked heat exchanger can lead to too low pressure or too high pressure leading to worse performance.

13.4 Checklist for yearly maintenance of the indoor unit

Check the following at least once a year:

- Water pressure
- Magnetic filter/dirt separator
- Water pressure relief valve
- Pressure relief valve of the domestic hot water tank
- Switch box

Water pressure

Keep water pressure above 1 bar. If it is lower, add water.

Magnetic filter/dirt separator

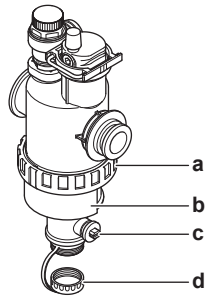

- a** Screw connection
- b** Magnetic sleeve
- c** Drain valve
- d** Drain cap

The yearly maintenance of the magnetic filter/dirt separator consists of:

- Checking if both parts of the magnetic filter/dirt separator are still screwed tight (a).
- Emptying the dirt separator as follows:

- 1 Take off the magnetic sleeve (b).
- 2 Unscrew the drain cap (d).
- 3 Connect a drain hose to the bottom of the water filter so that the water and dirt can be collected in a suitable container (bottle, sink...).
- 4 Open the drain valve for a couple of seconds (c).

Result: Water and dirt will come out.

- 5 Close the drain valve.
- 6 Screw the drain cap back on.
- 7 Reattach the magnetic sleeve.
- 8 Check the pressure of the water circuit. If required, add water.



NOTICE

- When checking the magnetic filter/dirt separator for tightness, hold it firmly, so as NOT to apply stress to the water piping.
- Do NOT isolate the magnetic filter/dirt separator by closing the shut-off valves. To properly empty the dirt separator, sufficient pressure is required.
- To prevent dirt from remaining in the dirt separator, ALWAYS take off the magnetic sleeve.
- ALWAYS first unscrew the drain cap, and connect a drain hose to the bottom of the water filter, then open the drain valve.

**INFORMATION**

For yearly maintenance, you do not have to remove the water filter from the unit to clean it. But in case of trouble with the water filter, you might have to remove it so that you can thoroughly clean it. Then you need to do as follows:

- "13.5.1 To remove the water filter" [▶ 182]
- "13.5.2 To clean the water filter in case of trouble" [▶ 182]
- "13.5.3 To install the water filter" [▶ 184]

Water pressure relief valve

Open the valve and check if it operates correctly. **The water may be very hot!**

Checkpoints are:

- The water flow coming from the relief valve is high enough, no blockage of the valve or in between piping is suspected.
- Dirty water coming out of the relief valve:
 - open the valve until the discharged water does NOT contain dirt anymore
 - flush the system

It is recommended to do this maintenance more frequently.

Pressure relief valve of the domestic hot water tank (field supply)

Open the valve.

**CAUTION**

Water coming out of the valve may be very hot.

- Check if nothing blocks the water in the valve or in between piping. The water flow coming from the relief valve must be high enough.
- Check if the water coming out of the relief valve is clean. If it contains debris or dirt:
 - Open the valve until the discharged water does not contain debris or dirt anymore.
 - Flush and clean the complete tank, including the piping between the relief valve and cold water inlet.

To make sure this water originates from the tank, check after a tank heat up cycle.

**INFORMATION**

It is recommended to perform this maintenance more than once a year.

Switch box

- Carry out a thorough visual inspection of the switch box and look for obvious defects such as loose connections or defective wiring.
- Using an ohmmeter, check if contactors K1M, K2M, K3M and K5M (depending on your installation) operate correctly. All contacts of these contactors must be in open position when the power is turned OFF.

**WARNING**

If the internal wiring is damaged, it has to be replaced by the manufacturer, its service agent or similarly qualified persons.

13.5 About cleaning the water filter in case of trouble



INFORMATION

For yearly maintenance, you do not have to remove the water filter from the unit to clean it. But in case of trouble with the water filter, you might have to remove it so that you can thoroughly clean it. Then you need to do as follows:

- ["13.5.1 To remove the water filter"](#) [▶ 182]
- ["13.5.2 To clean the water filter in case of trouble"](#) [▶ 182]
- ["13.5.3 To install the water filter"](#) [▶ 184]

13.5.1 To remove the water filter

Prerequisite: Stop the unit operation via the user interface.

Prerequisite: Turn OFF the respective circuit breaker.

- 1 The water filter is located behind the switch box. To get access to it, see: ["7.2.5 To open the indoor unit"](#) [▶ 63]
- 2 Close the stop valves of the water circuit.
- 3 Close the valve (if equipped) of the water circuit towards the expansion vessel.
- 4 Remove the cap on the bottom of the magnetic filter/dirt separator.
- 5 Connect a drain hose to the bottom of the water filter.
- 6 Open the valve on the bottom of the water filter to drain water from the water circuit. Collect the drained water in a bottle, sink,... using the installed drain hose.
- 7 Remove the 2 clips that fix the water filter.

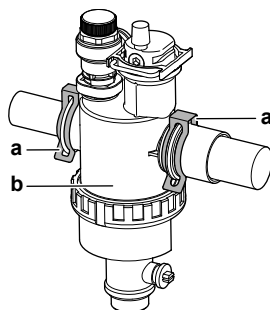

- a Clip
b Magnetic filter/dirt separator

- 8 Remove the water filter.
- 9 Remove the drain hose from the water filter.



NOTICE

Although the water circuit is drained, some water may be spilled when removing the magnetic filter/dirt separator from the filter housing. ALWAYS clean up spilled water.

13.5.2 To clean the water filter in case of trouble

- 1 Remove the water filter from the unit. See ["13.5.1 To remove the water filter"](#) [▶ 182].

**NOTICE**

To protect the piping connected to the magnetic filter/dirt separator from damage it is recommended to perform this procedure with the magnetic filter/dirt separator removed from the unit.

- 2 Unscrew the bottom of the water filter housing. Use an appropriate tool if needed.

**NOTICE**

Opening the magnetic filter/dirt separator is **ONLY** required in case of severe issues. Preferably this action is never to be done during the complete lifetime of the magnetic filter/dirt separator.

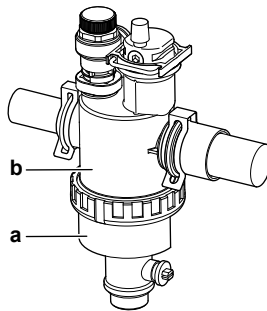

- a Bottom part to be unscrewed
- b Water filter housing

- 3 Remove the strainer and the rolled-up filter from the water filter housing and clean with water.
- 4 Install the cleaned rolled-up filter and strainer in the water filter housing.

**INFORMATION**

Correctly install the strainer in the magnetic filter/dirt separator housing using the protrusions.

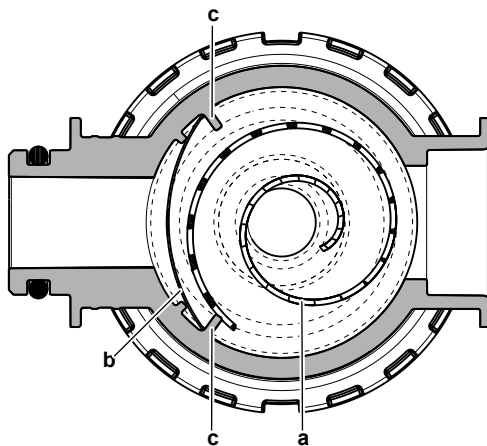

- a Rolled-up filter
- b Strainer
- c Protrusion

- 5 Install and properly tighten the bottom of the water filter housing.

13.5.3 To install the water filter



NOTICE

Check the condition of the O-rings and replace if needed. Apply water to the O-rings before installation.

- 1 Install the water filter in the correct location.

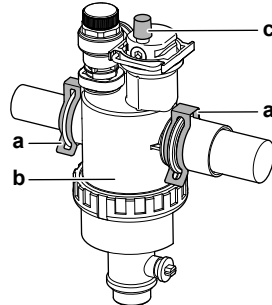

- a Clip
- b Magnetic filter/dirt separator
- c Air purge valve

- 2 Install the 2 clips to fix the water filter to the water circuit pipes.
- 3 Make sure that the air purge valve of the water filter is in the open position.
- 4 Open the valve (if equipped) of the water circuit towards the expansion vessel.



CAUTION

Make sure to open the valve (if equipped) towards the expansion vessel, otherwise the overpressure will be generated.

- 5 Open the stop valves and add water to the water circuit if needed.

14 Troubleshooting

Contact

For the symptoms listed below, you can try to solve the problem yourself. For any other problem, contact your installer. You can find the contact/helpdesk number via the user interface.

14.1 Overview: Troubleshooting

This chapter describes what you have to do in case of problems.

It contains information about:

- Solving problems based on symptoms
- Solving problems based on error codes

Before troubleshooting

Carry out a thorough visual inspection of the unit and look for obvious defects such as loose connections or defective wiring.

14.2 Precautions when troubleshooting



WARNING

- When carrying out an inspection on the switch box of the unit, ALWAYS make sure that the unit is disconnected from the mains. Turn off the respective circuit breaker.
- When a safety device was activated, stop the unit and find out why the safety device was activated before resetting it. NEVER shunt safety devices or change their values to a value other than the factory default setting. If you are unable to find the cause of the problem, call your dealer.



DANGER: RISK OF ELECTROCUTION



WARNING

Prevent hazards due to inadvertent resetting of the thermal cut-out: power to this appliance MUST NOT be supplied through an external switching device, such as a timer, or connected to a circuit that is regularly turned ON and OFF by the utility.



DANGER: RISK OF BURNING/SCALDING

14.3 Solving problems based on symptoms

14.3.1 Symptom: The unit is NOT heating or cooling as expected

Possible causes	Corrective action
The temperature setting is NOT correct	Check the temperature setting on the remote controller. Refer to the operation manual.
The water flow is too low	<p>Check and make sure that:</p> <ul style="list-style-type: none"> ▪ All shut-off valves of the water circuit are completely open. ▪ The water filter is clean. Clean if necessary. ▪ There is no air in the system. Purge air if necessary. You can purge air manually (see "To perform a manual air purge" [▶ 172]) or use the automatic air purge function (see "To perform an automatic air purge" [▶ 172]). ▪ The water pressure is >1 bar. ▪ The expansion vessel is NOT broken. ▪ The valve (if equipped) of the water circuit towards the expansion vessel is open. ▪ The resistance in the water circuit is NOT too high for the pump (see the ESP curve in the "Technical data" chapter). <p>If the problem persists after you have conducted all of the above checks, contact your dealer. In some cases, it is normal that the unit decides to use a low water flow.</p>
The water volume in the installation is too low	Make sure that the water volume in the installation is above the minimum required value (see " 8.1.3 To check the water volume and flow rate " [▶ 73]).



14.3.2 Symptom: Hot water does NOT reach the desired temperature

Possible causes	Corrective action
One of the tank temperature sensors is broken.	See the service manual of the unit for the corresponding corrective action.

14.3.3 Symptom: The compressor does NOT start (space heating or domestic water heating)



Possible causes	Corrective action
The compressor cannot start if the water temperature is too low. The unit will use the backup heater to reach the minimum water temperature (15°C), after which the compressor can start.	<p>If the backup heater doesn't start either, check and make sure that:</p> <ul style="list-style-type: none"> ▪ The power supply to the backup heater is correctly wired. ▪ The backup heater thermal protector is NOT activated. ▪ The backup heater contactors are NOT broken. <p>If the problem persists, contact your dealer.</p>
The preferential kWh rate power supply settings and electrical connections do NOT match	<p>This should match with the connections as explained in:</p> <ul style="list-style-type: none"> ▪ "9.3.1 To connect the main power supply" [▶ 89] ▪ "9.1.4 About preferential kWh rate power supply" [▶ 86] ▪ "9.1.5 Overview of electrical connections except external actuators" [▶ 87]
The preferential kWh rate signal was sent by the electricity company	<p>In the user interface of the unit, go to [8.5.B] Information > Actuators > Forced off contact.</p> <p>If Forced off contact is On, the unit is operating under the preferential kWh rate. Wait for the power to return (maximum 2 hours).</p>

14.3.4 Symptom: The system is making gurgling noises after commissioning

Possible cause	Corrective action
There is air in the system.	Purge air from the system. ^(a)
Incorrect hydraulic balance.	<p>To be performed by the installer:</p> <ol style="list-style-type: none"> 1 Perform hydraulic balancing to assure that the flow is correctly distributed between the emitters. 2 If hydraulic balancing is not sufficient, change the pump limitation settings ([9-0D] and [9-0E] if applicable).
Various malfunctions.	<p>Check if  or  is displayed on the home screen of the user interface. See "14.4.1 To display the help text in case of a malfunction" [▶ 191] for more information about the malfunction.</p>

^(a) We recommend to purge air with the air purge function of the unit (to be performed by the installer). If you purge air from the heat emitters or collectors, mind the following:

**WARNING**

Air purging heat emitters or collectors. Before you purge air from heat emitters or collectors, check if  or  is displayed on the home screen of the user interface.

- If not, you can purge air immediately.
- If yes, make sure that the room where you want to purge air is sufficiently ventilated. **Reason:** Refrigerant might leak into the water circuit, and subsequently into the room when you purge air from the heat emitters or collectors.

14.3.5 Symptom: The pump is making noise (cavitation)

Possible causes	Corrective action
There is air in the system	Purge air manually (see "To perform a manual air purge" [▶ 172]) or use the automatic air purge function (see "To perform an automatic air purge" [▶ 172]).
The water pressure at the pump inlet is too low	Check and make sure that: <ul style="list-style-type: none"> ▪ The water pressure is >1 bar. ▪ The water pressure sensor is not broken. ▪ The expansion vessel is NOT broken. ▪ The valve (if equipped) of the water circuit towards the expansion vessel is open. ▪ The pre-pressure setting of the expansion vessel is correct (see "8.1.4 Changing the pre-pressure of the expansion vessel" [▶ 76]).

14.3.6 Symptom: The pressure relief valve opens

Possible causes	Corrective action
The expansion vessel is broken	Replace the expansion vessel.
The valve (if equipped) of the water circuit towards the expansion vessel is closed.	Open the valve.
The water volume in the installation is too high	Make sure that the water volume in the installation is below the maximum allowed value (see "8.1.3 To check the water volume and flow rate" [▶ 73] and "8.1.4 Changing the pre-pressure of the expansion vessel" [▶ 76]).

Possible causes	Corrective action
The water circuit head is too high	The water circuit head is the difference in height between the indoor unit and the highest point of the water circuit. If the indoor unit is located at the highest point of the installation, the installation height is considered 0 m. The maximum water circuit head is 10 m. Check the installation requirements.

14.3.7 Symptom: The water pressure relief valve leaks

Possible causes	Corrective action
Dirt is blocking the water pressure relief valve outlet	Check whether the pressure relief valve works correctly by turning the red knob on the valve counterclockwise: <ul style="list-style-type: none"> ▪ If you do NOT hear a clacking sound, contact your dealer. ▪ If the water keeps running out of the unit, close both the water inlet and outlet shut-off valves first and then contact your dealer.

14.3.8 Symptom: The space is NOT sufficiently heated at low outdoor temperatures

Possible causes	Corrective action
The backup heater operation is not activated	Check the following: <ul style="list-style-type: none"> ▪ The backup heater operation mode is enabled. Go to: [9.3.8]: Installer settings > Backup heater > Operation [4-00] ▪ The backup heater overcurrent circuit breaker is on. If not, turn it back on. ▪ The thermal protector of the backup heater is NOT activated. If it has, check the following, and then press the reset button in the switch box: <ul style="list-style-type: none"> - The water pressure - Whether there is air in the system - The air purge operation
The backup heater equilibrium temperature has not been configured correctly	Increase the equilibrium temperature to activate the backup heater operation at a higher outdoor temperature. Go to: [9.3.7]: Installer settings > Backup heater > Equilibrium temperature [5-01]

Possible causes	Corrective action
There is air in the system.	Purge air manually or automatically. See the air purge function in the chapter " 11 Commissioning " [▶ 169].
Too much heat pump capacity is used for heating domestic hot water (applies only to installations with a domestic hot water tank)	<p>Check if the Space heating priority settings have been configured appropriately:</p> <ul style="list-style-type: none"> Make sure that the Space heating priority has been enabled. Go to [9.6.1]: Installer settings > Balancing > Space heating priority [5-02] Increase the "space heating priority temperature" to activate backup heater operation at a higher outdoor temperature. Go to [9.6.3]: Installer settings > Balancing > Offset BSH setpoint [5-03]

14.3.9 Symptom: The pressure at the tapping point is temporarily unusually high

Possible causes	Corrective action
Failing or blocked pressure relief valve.	<ul style="list-style-type: none"> Flush and clean the complete tank including the piping between pressure relief valve and the cold water inlet. Replace the pressure relief valve.

14.3.10 Symptom: Decoration panels are pushed away due to a swollen tank

Possible causes	Corrective action
Failing or blocked pressure relief valve.	Contact your local dealer.

14.3.11 Symptom: Tank disinfection function is NOT completed correctly (AH-error)

Possible causes	Corrective action
The disinfection function was interrupted by domestic hot water tapping	Program the start-up of the disinfection function when the coming 4 hours NO domestic hot water tapping is expected.

Possible causes	Corrective action
Large domestic hot water tapping happened recently before the programmed start-up of the disinfection function	<p>If in [5.6] Tank > Heat up mode the mode Reheat only or Schedule + reheat is selected, it is recommended to program the start-up of the disinfection function at least 4 hours later than the last expected large hot water tapping. This start-up can be set by installer settings (disinfection function).</p> <p>If in [5.6] Tank > Heat up mode the mode Schedule only is selected, it is recommended to program a Eco action 3 hours before the scheduled start-up of the disinfection function to preheat the tank.</p>
The disinfection operation was stopped manually: [C.3] Operation > Tank was turned off during disinfection.	Do NOT stop tank operation during disinfection.

14.4 Solving problems based on error codes



If the unit runs into a problem, the user interface displays an error code. It is important to understand the problem and to take measures before resetting an error code. This should be done by a licensed installer or by your local dealer.

This chapter gives you an overview of all possible error codes and their descriptions as they appear on the user interface.

For detailed troubleshooting of each error, see the service manual.

14.4.1 To display the help text in case of a malfunction

In case of a malfunction, the following will appear on the home screen depending on the severity:

- : Error
- : Malfunction

You can get a short and a long description of the malfunction as follows:

1	Press the left dial to open the main menu and go to Malfunctioning . Result: A short description of the error and the error code is displayed on the screen.	
2	Press ? in the error screen. Result: A long description of the error is displayed on the screen.	?

14.4.2 Error codes: Overview

Error codes of the unit

Error code	Detailed error code	Description
7H	01	Water flow problem
7H	04	Water flow problem during domestic hot water production
7H	05	Water flow problem during heating/sampling
7H	06	Water flow problem during cooling/defrost
7H	07	Water flow problem. Pump deblocking active
80	01	Entering water thermistor abnormality of outdoor unit
81	00	Leaving water temperature sensor problem
81	06	Entering water temperature thermistor abnormality (indoor unit)
89	01	Heat exchanger freeze-up protection activated during defrost (error)
89	02	Heat exchanger freeze-up protection activated during heating / DHW
89	03	Heat exchanger freeze-up protection activated during defrost (warning)
89	05	Heat exchanger freeze-up protection activated during cooling (error)
89	06	Heat exchanger freeze-up protection activated during defrost (warning)
8F	00	Abnormal increase outlet water temperature (DHW)
8H	00	Abnormal increase outlet water temperature
8H	03	Overheating water circuit (thermostat)
A1	00	Zero cross detection problem
A5	00	OU: High pressure peak cut / freeze protection problem
AA	01	Backup heater overheated or BUH power cable not connected

Error code	Detailed error code	Description
AA	02	External backup heater overheated
AC	00	Booster heater overheated
AH	00	Tank disinfection function not completed correctly
AJ	03	Too long DHW heat-up time required
C0	00	Flow sensor malfunction
C0	01	Flow switch malfunction
C0	02	Flow switch malfunction
C4	00	Heat exchanger temperature sensor problem
C5	00	Heat exchanger thermistor abnormality
CJ	02	Room temperature sensor problem
E1	00	OU: PCB defect
E2	00	Leakage current detection error
E3	00	OU: Actuation of high pressure switch (HPS)
E4	00	Abnormal suction pressure
E5	00	OU: Overheat of inverter compressor motor
E6	00	OU: Compressor startup defect
E7	00	OU: Malfunction of outdoor unit fan motor
E8	00	OU: Power input overvoltage
E9	00	Malfunction of electronic expansion valve
EA	00	OU: Cool/heat switchover problem
EC	00	Abnormal increase tank temperature
EC	04	Tank preheating
F3	00	OU: Malfunction of discharge pipe temperature
F6	00	OU: Abnormal high pressure in cooling
FA	00	OU: Abnormal high pressure, actuation of HPS

Error code	Detailed error code	Description
H0	00	OU: Voltage/current sensor problem
H1	00	External temperature sensor problem
H3	00	OU: Malfunction of high pressure switch (HPS)
H4	00	Malfunction of low pressure switch
H5	00	Malfunction of compressor overload protection
H6	00	OU: Malfunction of position detection sensor
H8	00	OU: Malfunction of compressor input (CT) system
H9	00	OU: Malfunction of outdoor air thermistor
HC	00	Tank temperature sensor problem
HJ	10	Water pressure sensor abnormality
HJ	11	Boiler abnormality detection
J3	00	OU: Malfunction of discharge pipe thermistor
J5	00	Malfunction of suction pipe thermistor
J6	00	OU: Malfunction of heat exchanger thermistor
J6	07	OU: Malfunction of heat exchanger thermistor
J6	32	Leaving water temperature thermistor Abnormality (outdoor unit)
J6	33	Sensor communication error
J8	00	Malfunction of refrigerant liquid thermistor
JA	00	OU: Malfunction of high pressure sensor
JA	17	Refrigerant pressure sensor abnormality
L1	00	Malfunction of INV PCB
L3	00	OU: Electrical box temperature rise problem

Error code	Detailed error code	Description
L4	00	OU: Malfunction of inverter radiating fin temperature rise
L5	00	OU: Inverter instantaneous overcurrent (DC)
L8	00	Malfunction triggered by a thermal protection in the inverter PCB
L9	00	Prevention of compressor lock
LC	00	Malfunction in communication system of outdoor unit
P1	00	Open-phase power supply imbalance
P3	00	Abnormal direct current
P4	00	OU: Malfunction of radiating fin temperature sensor
PJ	00	Capacity setting mismatch
U0	00	OU: Shortage of refrigerant
U1	00	Malfunction by reverse phase/open-phase
U2	00	OU: Defect of power supply voltage
U3	00	Underfloor heating screed dryout function not completed correctly
U4	00	Indoor/outdoor unit communication problem
U5	00	User interface communication problem
U7	00	OU: Transmission malfunction between main CPU- INV CPU
U8	01	Connection with LAN adapter lost
U8	02	Connection with room thermostat lost
U8	03	No connection with room thermostat
U8	04	Unknown USB device
U8	05	File malfunction
U8	07	P1P2 communication error
UA	00	Indoor unit, outdoor unit matching problem
UA	17	Tank type problem

Error code	Detailed error code	Description
UA	21	Extension/hydro mismatch problem
UA	22	Communication problem between control box and option box
UF	00	Reversed piping or bad communication wiring detection

**INFORMATION**

In case of error code AH and no interruption of the disinfection function occurred due to domestic hot water tapping, following actions are recommended:

- When the **Reheat only** or **Schedule + reheat** mode is selected, it is recommended to program the start-up of the disinfection function at least 4 hours later than the last expected large hot water tapping. This start-up can be set by installer settings (disinfection function).
- When the **Schedule only** mode is selected, it is recommended to program an **Eco** action 3 hours before the scheduled start-up of the disinfection function to preheat the tank.

**NOTICE**

When the minimum water flow is lower than described in the table below, the unit will temporarily stop operation and the user interface will display error 7H-01. After some time, this error will reset automatically and the unit will resume operation.

Minimum required flow rate

20 l/min

**INFORMATION**

Error AJ-03 is reset automatically from the moment there is a normal tank heat-up.

**INFORMATION**

In case of an E7-62 error, brine pump operation stops due to not enough flow in the brine circuit. If 10-day brine pump operation is running, it will stop running and will only resume once the error is reset. It is only possible to reset the error with the domestic hot water home screen or the leaving water temperature home screen turned ON. To reset the error, press **⏏** and confirm by pressing **OK**.

**INFORMATION**

If an U8-04 error occurs, the error can be reset after a successful update of the software. If the software is not successfully updated then you must make sure that your USB device has the FAT32 format.

**INFORMATION**

If the booster heater overheats and is disabled by the thermostatic safety, the unit will not give an error directly. Check if the booster heater is still in operation if you experience one or more of the following errors:

- Powerful operation takes a very long time to heat up and the error code AJ-03 is displayed.
- During anti-legionella operation (weekly), the error code AH-00 is displayed because the unit cannot reach the requested temperature required for tank disinfection.

**INFORMATION**

A malfunctioning booster heater will have an impact on energy metering and power consumption control.

**INFORMATION**

The user interface will display how to reset an error code.

15 Disposal



NOTICE

Do NOT try to dismantle the system yourself: dismantling of the system, treatment of the refrigerant, oil and other parts MUST comply with applicable legislation. Units MUST be treated at a specialised treatment facility for reuse, recycling and recovery.

In this chapter

15.1	To recover refrigerant	198
15.1.1	To open the stop valves	199
15.1.2	To manually open the electronic expansion valves.....	199
15.1.3	Recovery mode.....	200

15.1 To recover refrigerant

When disposing of the outdoor unit, you need to recover its refrigerant.

To ensure that no refrigerant remains trapped in the unit:

- Make sure the stop valves are open (**a**, **b**).
- Make sure the valves (**Y1E**, **Y3E**, **Y2S**, **Y3S**) are open.
- Use all 3 service ports (**a**, **b**, **c**) to recover refrigerant.

Components

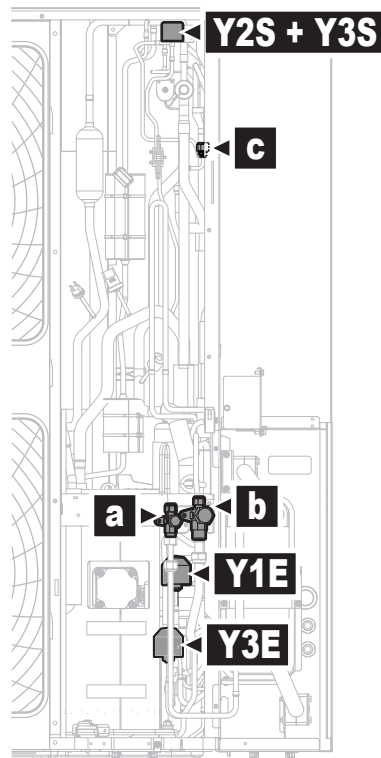

- a** Liquid stop valve with service port
- b** Gas stop valve with service port
- c** Service port 5/16" flare
- Y1E** Electronic expansion valve (main)
- Y3E** Electronic expansion valve (injection)
- Y2S** Solenoid valve (injection bypass)
- Y3S** Solenoid valve (hot gas bypass)

To recover refrigerant when power is ON

- 1 Make sure the unit is not running.
- 2 Make sure the stop valves are open (see "15.1.1 To open the stop valves" [▶ 199]).
- 3 Activate the recovery mode (see "15.1.3 Recovery mode" [▶ 200]).

Result: The unit opens the electronic expansion valves.

- 4 Recover refrigerant from the 3 service ports.
- 5 Deactivate the recovery mode (see "15.1.3 Recovery mode" [▶ 200]).

Result: The unit returns the electronic expansion valves to their initial state.

To recover refrigerant when power is OFF

- 1 Make sure the stop valves are open (see "15.1.1 To open the stop valves" [▶ 199]).
- 2 Manually open the valves (Y*) (see "15.1.2 To manually open the electronic expansion valves" [▶ 199]).
- 3 Recover refrigerant from the 3 service ports.

15.1.1 To open the stop valves

Before recovering refrigerant, make sure the stop valves are open.

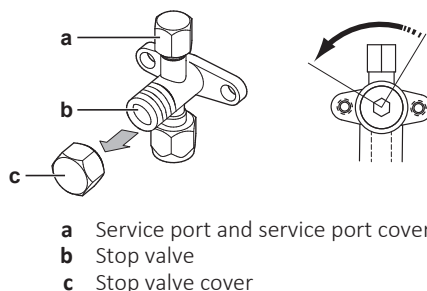

- 1 Remove the stop valve cover.
- 2 Insert a hexagon wrench into the stop valve and turn counterclockwise to open.

15.1.2 To manually open the electronic expansion valves

Before recovering refrigerant, make sure the electronic expansion valves are open. When power is OFF, this has to be done manually.

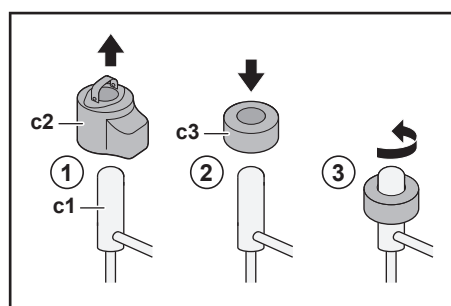

c1 Electronic expansion valve
c2 EEV coil
c3 EEV magnet

- 1 Remove the EEV coil (c2).
- 2 Slide an EEV magnet (c3) over the expansion valve (c1).

- Turn the EEV magnet anticlockwise to the fully open position of the valve. If you are not sure about what the open position is, turn the valve in its middle position so that refrigerant can pass.

15.1.3 Recovery mode

Before recovering refrigerant, make sure the electronic expansion valves are open. When power is ON, this has to be done by using the recovery mode.

Components

To activate/deactivate the recovery mode, you need the following components:

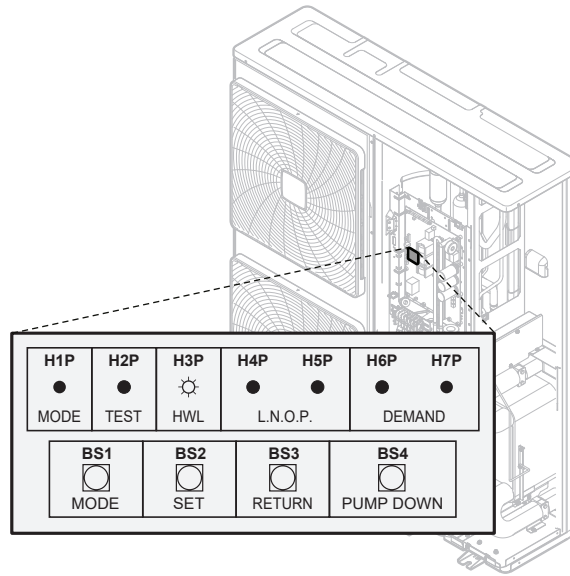

H1P~H7P 7-LEDs display

BS1~BS4 Push buttons. Operate the push buttons with an insulated stick (such as a closed ballpoint pen) to avoid touching of live parts.

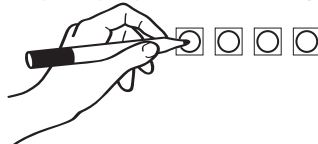

To activate the recovery mode



INFORMATION

If you get confused in the middle of the process, press BS1 to return to the default situation.

Before recovering refrigerant, activate the recovery mode as follows:

#	Action	7-LEDs display ^(a)						
		H1P	H2P	H3P	H4P	H5P	H6P	H7P
1	Start from the default situation.	●	●	●	●	●	●	●
2	Press and hold BS1 for 5 seconds.	○	●	●	●	●	●	●
3	Press BS2 9 times.	○	●	●	○	●	●	○
4	Press BS3 once.	○	●	●	●	●	●	◐
5	Press BS2 once.	○	●	●	●	●	◐	●
6	Press BS3 once.	○	●	●	●	●	○	●

#	Action	7-LEDs display ^(a)						
		H1P	H2P	H3P	H4P	H5P	H6P	H7P
7	Press BS3 once. The flashing H1P indicates the recovery mode has been correctly selected and is activated.	◐	●	●	●	●	●	●
8	Press BS1 once. H1P keeps flashing, indicating that you are in a mode that does not allow compressor operation.	◐	●	●	●	●	●	●

^(a) ● = OFF, ○ = ON, and ◐ = flashing.

Result: The recovery mode is activated. The unit opens the electronic expansion valves / solenoid valves.

To deactivate the recovery mode

After recovering refrigerant, deactivate the recovery mode as follows:

#	Procedure	7-LEDs display ^(a)						
		H1P	H2P	H3P	H4P	H5P	H6P	H7P
1	Press and hold BS1 for 5 seconds.	◐	●	●	●	●	●	●
2	Press BS2 9 times.	◐	●	●	○	●	●	○
3	Press BS3 once.	◐	●	●	●	●	◐	●
4	Press BS2 once.	◐	●	●	●	●	●	◐
5	Press BS3 once.	◐	●	●	●	●	●	○
6	Press BS3 once.	◐	●	●	●	●	●	●
7	Press BS1 once to return to the default situation.	●	●	●	●	●	●	●

^(a) ● = OFF, ○ = ON, and ◐ = flashing.

Result: The recovery mode is deactivated. The unit returns the electronic expansion valves / solenoid valves to their initial state.



INFORMATION

Power OFF. When power is turned OFF and turned ON again, the recovery mode is deactivated automatically.

16 Technical data

A **subset** of the latest technical data is available on the regional Daikin website (publicly accessible). The **full set** of latest technical data is available on the Daikin Business Portal (authentication required).

16.1 Service space: Outdoor unit

Single unit

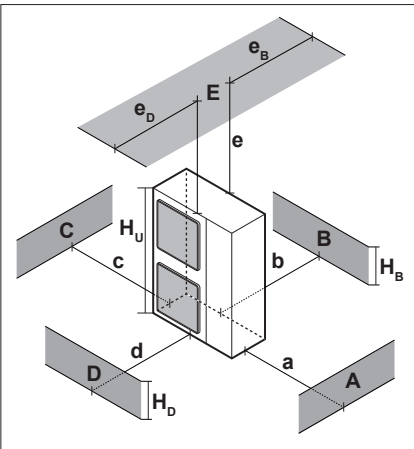

A~E	H _B H _D H _U	(mm)							
		a	b	c	d	e	e _B	e _D	H
A, B, C	—	≥500	≥300	≥100					≥150
A, B, C, E	—	≥500	≥300	≥150		≥1000		≤500	≥150
D	—				≥500				≥150
D, E	—				≥500	≥1000	≤500		≥150
B, D	H _D < H _U		≥300		≥500				≥150
B, D, E	H _D < H _U & H _B > H _U		≥300		≥1000	≥1000		≤500	≥150
	H _D > H _U & H _B < H _U		≥300		≥1000	≥1000	≤500		≥150

- A,C** Left side and right side obstacles (walls/baffle plates)
- B** Suction side obstacle (wall/baffle plate)
- D** Discharge side obstacle (wall/baffle plate)
- E** Top side obstacle (roof)

- a,b,c,d,e** Minimum service space between the unit and obstacles A, B, C, D and E
- e_B** Maximum distance between the unit and the edge of obstacle E, in the direction of obstacle B
- e_D** Maximum distance between the unit and the edge of obstacle E, in the direction of obstacle D
- H_U** Height of the unit including the installation structure
- H_B,H_D** Height of obstacles B and D
- H** Height of installation structure below the unit



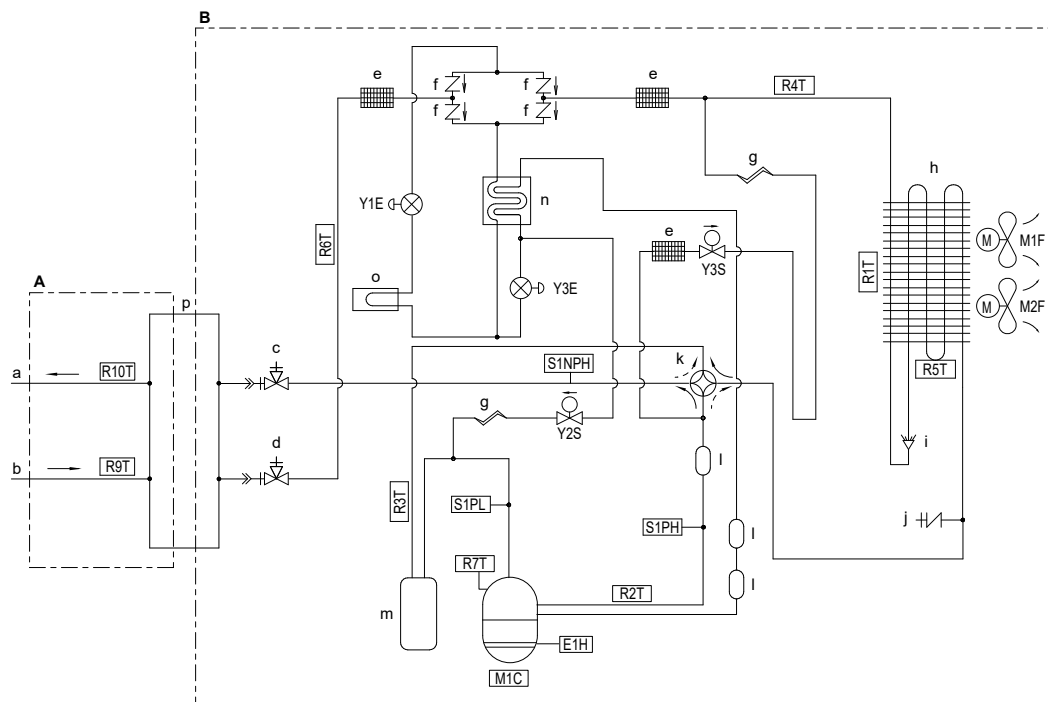

16.2 Piping diagram: Outdoor unit

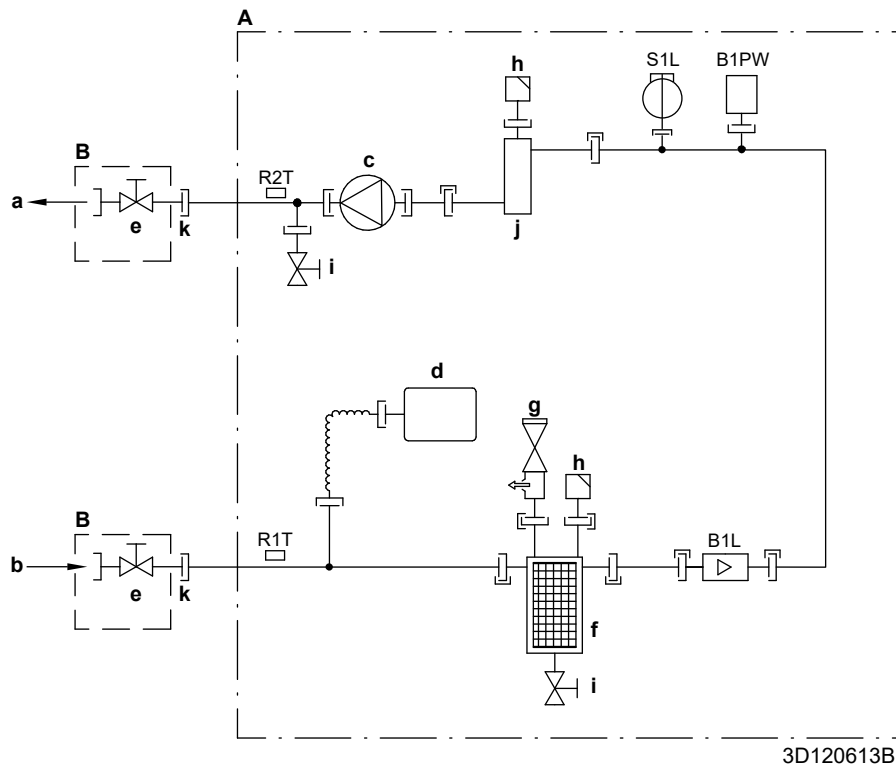

- | | |
|--|--|
| A Water side | E1H Crankcase heater |
| B Refrigerant side | M1C Compressor |
| a Water OUT, male 1" | M1F Upper fan motor |
| b Water IN, male 1" | M2F Lower fan motor |
| c Gas stop valve with service port | R1T Thermistor (outdoor air) |
| d Liquid stop valve with service port | R2T Thermistor (compressor discharge) |
| e Refrigerant filter | R3T Thermistor (compressor suction) |
| f One-way valve | R4T Thermistor (air heat exchanger liquid pipe) |
| g Capillary tube | R5T Thermistor (air heat exchanger middle) |
| h Heat exchanger | R6T Thermistor (refrigerant liquid) |
| i Distributor | R7T Thermistor (compressor protection) |
| j Service port 5/16" flare | R9T Thermistor (entering water) |
| k 4-way valve | R10T Thermistor (leaving water) |
| l Muffler | S1PH High pressure switch |
| m Accumulator | S1PL Low pressure switch |
| n Economiser heat exchanger | S1NPH High pressure sensor |
| o Inverter PCB heat sink | Y1E Electronic expansion valve (main) |
| p Plate heat exchanger | Y2S Solenoid valve (injection bypass) |
| | Y3E Electronic expansion valve (injection) |
| | Y3S Solenoid valve (hot gas bypass) |
| | ➔ Heating |
| | ➔➔ Cooling |

16.3 Piping diagram: Indoor unit



- A** Indoor unit
- B** Field installed
- a** Space heating water OUT
- b** Water IN connection
- c** Pump
- d** Expansion vessel
- e** Shut-off valve, male-female 1"
- f** Magnetic filter/dirt separator
- g** Safety valve
- h** Air purge
- i** Drain valve
- j** Backup heater
- k** Loose nut 1"
- B1L** Flow sensor
- B1PW** Space heating water pressure sensor
- R1T** Thermistor (water IN)
- R2T** Thermistor (backup heater – water OUT)
- S1L** Flow switch
-  Screw connection
-  Flare connection
-  Quick coupling
-  Braze connection









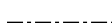
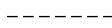

16.4 Wiring diagram: Outdoor unit

The wiring diagram is delivered with the unit, located at the inside of the service cover.

(1) Connection diagram

English	Translation
Connection diagram	Connection diagram
Only for ***	Only for ***
See note ***	See note ***
Outdoor	Outdoor
Indoor	Indoor
Position of compressor terminal	Position of compressor terminal
Position in switch box	Position in switch box
Front	Front
Right	Right
Back	Back
Upper	Upper
Lower	Lower
Fan	Fan
ON	ON
OFF	OFF

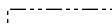
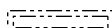
(2) Notes

English	Translation
Notes	Notes
L	Live
N	Neutral
	Connection
	Connector
	Earth wiring
	Field supply
	Protective earth
	Noiseless earth
	Field wire
	Terminal
	Terminal strip
	Wiring depending on model
	Option
	Switch box

English	Translation
<input type="text"/>	PCB

NOTES:

- 1 Colours: BLK: black, RED: red, BLU: blue, WHT: white, GRN: green, YLW: yellow, PNK: pink, ORG: orange.
- 2 This wiring diagram applies only to the outdoor unit.
- 3 When operating, do not short-circuit protective devices S1PH and S1PL
- 4 Refer to the combination table and the option manual for how to connect the wiring to X6A, X4A and X41A.
- 5 Refer to the service manual for instructions on how to set the selector switches (DS1). The factory setting of all switches is OFF.

(3) Legend

English	Translation
Legend	Legend
Field supply	Field supply
Optional	Optional
Part n°	Part n°
Description	Description

A1P	Printed circuit board (main)
A2P	Printed circuit board (noise filter)
A3P	Printed circuit board (leakage current)
A4P	Printed circuit board (ACS)
BS1~BS4 (A1P)	Push button switch
C1~C4 (A1P, A2P)	Capacitor
DS1 (A1P)	Dipswitch
E1H	Crankcase heater
E2H	Bottom plate heater (option)
E3H~E5H	Plate heat exchanger heaters
F1U~F4U (A2P)	Fuse
F6U (A1P)	Fuse (T 5.0 A / 250 V)
H1P~H7P (A1P)	Light-emitting diode (service monitor is orange)
HAP (A1P)	Light-emitting diode (service monitor is green)
K1R (A1P)	Magnetic relay (Y1S)
K1R (A4P)	Magnetic relay (E3H~E5H)
K2R (A1P)	Magnetic relay (Y2S)
K2R (A4P)	Magnetic relay (E2H)
K3R (A1P)	Magnetic relay (Y3S)
K4R (A1P)	Magnetic relay (E1H)

K10R (A1P)	Magnetic relay
K11M (A1P)	Magnetic contactor
K13R~K15R (A1P, A2P)	Magnetic relay
L1R~L3R (A1P)	Reactor
M1C	Compressor motor
M1F~M2F	Fan motor
PS (A1P)	Switching power supply
Q1DI	Earth leakage circuit breaker (30 mA) (field supply)
R1~R5 (A1P, A2P)	Resistor
R1T	Thermistor (outdoor air)
R2T	Thermistor (compressor discharge)
R3T	Thermistor (compressor suction)
R4T	Thermistor (air heat exchanger liquid pipe)
R5T	Thermistor (air heat exchanger middle)
R6T	Thermistor (refrigerant liquid)
R7T	Thermistor (compressor protection)
R9T	Thermistor (entering water)
R10T	Thermistor (leaving water)
R11T	Thermistor (fin)
RC (A2P)	Signal receiver circuit
S1NPH	High pressure sensor
S1PH	High pressure switch
S1PL	Low pressure switch
T1A	Current sensor
TC (A2P)	Signal transmission circuit
V1D~V4D (A1P)	Diode
V1R (A1P)	IGBT power module
V2R (A1P)	Diode module
V1T~V3T (A1P)	Insulated Gate Bipolar Transistor (IGBT)
X1M	Terminal strip
Y1E	Electronic expansion valve (main)
Y3E	Electronic expansion valve (injection)
Y1S	Solenoid valve (4-way valve)
Y2S	Solenoid valve (injection bypass)
Y3S	Solenoid valve (hot gas bypass)
Z1C~Z11C	Noise filter (ferrite core)
Z1F~Z6F (A1P, A2P)	Noise filter

16.5 Wiring diagram: Indoor unit

See the internal wiring diagram supplied with the unit (on the inside of the indoor unit upper front panel). The abbreviations used are listed below.

Notes to go through before starting the unit

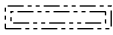
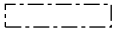
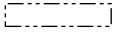
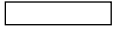
English	Translation
Notes to go through before starting the unit	Notes to go through before starting the unit
X1M	Main terminal
X2M	Field wiring terminal for AC
X5M	Field wiring terminal for DC
X6M	Backup heater power supply terminal
X7M/X8M	Booster heater power supply terminal
-----	Earth wiring
-----	Field supply
①	Several wiring possibilities
	Option
	Not mounted in switch box
	Wiring depending on model
	PCB
Note 1: Connection point of the power supply for the BUH/BSH should be foreseen outside the unit.	Note 1: Connection point of the power supply for the backup heater should be foreseen outside the unit.
Backup heater power supply	Backup heater power supply
<input type="checkbox"/> 3V3 (1N~, 230 V, 3 kW)	<input type="checkbox"/> 3V3 (3~, 230 V, 6 kW)
<input type="checkbox"/> 6T1 (3~, 230 V, 6 kW)	<input type="checkbox"/> 6T1 (3~, 230 V, 6 kW)
<input type="checkbox"/> 6V3 (1N~, 230 V, 6 kW)	<input type="checkbox"/> 6V3 (1N~, 230 V, 6 kW)
<input type="checkbox"/> 6WN (3N~, 400 V, 6 kW)/9WN (3N~, 400 V, 9 kW)	<input type="checkbox"/> 6WN/9WN (3N~, 400 V, 6 kW)
User installed options	User installed options
<input type="checkbox"/> LAN adapter	<input type="checkbox"/> LAN adapter
<input type="checkbox"/> Domestic hot water tank	<input type="checkbox"/> Domestic hot water tank
<input type="checkbox"/> Remote user interface	<input type="checkbox"/> User interface used as room thermostat
<input type="checkbox"/> Ext. indoor thermistor	<input type="checkbox"/> External indoor thermistor
<input type="checkbox"/> Ext outdoor thermistor	<input type="checkbox"/> External outdoor thermistor
<input type="checkbox"/> Digital I/O PCB	<input type="checkbox"/> Digital I/O PCB
<input type="checkbox"/> Demand PCB	<input type="checkbox"/> Demand PCB
<input type="checkbox"/> Bottom plate heater	<input type="checkbox"/> Bottom plate heater
Main LWT	Main leaving water temperature

English	Translation
<input type="checkbox"/> On/OFF thermostat (wired)	<input type="checkbox"/> On/OFF thermostat (wired)
<input type="checkbox"/> On/OFF thermostat (wireless)	<input type="checkbox"/> On/OFF thermostat (wireless)
<input type="checkbox"/> Ext. thermistor	<input type="checkbox"/> External thermistor
<input type="checkbox"/> Heat pump convector	<input type="checkbox"/> Heat pump convector
<input type="checkbox"/> Safety thermostat	<input type="checkbox"/> Safety thermostat
Add LWT	Additional leaving water temperature
<input type="checkbox"/> On/OFF thermostat (wired)	<input type="checkbox"/> On/OFF thermostat (wired)
<input type="checkbox"/> On/OFF thermostat (wireless)	<input type="checkbox"/> On/OFF thermostat (wireless)
<input type="checkbox"/> Ext. thermistor	<input type="checkbox"/> External thermistor
<input type="checkbox"/> Heat pump convector	<input type="checkbox"/> Heat pump convector

Position in switch box

English	Translation
Position in switch box	Position in switch box

Legend

A1P		Main PCB
A2P	*	On/OFF thermostat (PC=power circuit)
A3P	*	Heat pump convector
A4P	*	Digital I/O PCB
A8P	*	Demand PCB
A10P		MMI (= user interface connected to the indoor unit) – Power supply unit PCB
A11P		MMI (= user interface connected to the indoor unit) – Main PCB
A13P	*	LAN adapter
A14P	*	User interface PCB
A15P	*	Receiver PCB (wireless On/OFF thermostat)
BSK (A3P)	*	Solar pump station relay
CN* (A4P)	*	Connector
DS1(A8P)	*	DIP switch
F1B	#	Overcurrent fuse backup heater
F2B	#	Overcurrent fuse booster heater
F1U, F2U (A4P)	*	Fuse 5 A 250 V for digital I/O PCB
K1M, K2M		Contactors backup heater
K3M		Contactors booster heater
K5M		Safety contactors backup heater
K*R (A4P)		Relay on PCB
M2P	#	Domestic hot water pump

M2S	#	2-way valve for cooling mode
M3S	#	3-way valve for floorheating/domestic hot water
PC (A15P)	*	Power circuit
PHC1 (A4P)	*	Optocoupler input circuit
Q2L		Thermal protector booster heater
Q4L	#	Safety thermostat
Q*DI	#	Earth leakage circuit breaker
R1H (A2P)	*	Humidity sensor
R1T (A2P)	*	Ambient sensor On/OFF thermostat
R2T (A2P)	*	External sensor (floor or ambient)
R6T	*	External indoor or outdoor ambient thermistor
S1S	#	Preferential kWh rate power supply contact
S2S	#	Electricity meter pulse input 1
S3S	#	Electricity meter pulse input 2
S6S~S9S	*	Digital power limitation inputs
SS1 (A4P)	*	Selector switch
TR1		Power supply transformer
X6M	#	Backup heater power supply terminal strip
X7M/X8M	#	Booster heater power supply terminal strip
X*, X*A, X*Y, Y*		Connector
X*M		Terminal strip

* Optional
Field supply

Translation of text on wiring diagram

English	Translation
(1) Main power connection	(1) Main power connection
For preferential kWh rate power supply	For preferential kWh rate power supply
Indoor unit supplied from outdoor	Indoor unit supplied from outdoor
Normal kWh rate power supply	Normal kWh rate power supply
Only for normal power supply (standard)	Only for normal power supply (standard)
Only for preferential kWh rate power supply (outdoor)	Only for preferential kWh rate power supply (outdoor)
Outdoor unit	Outdoor unit
Preferential kWh rate power supply contact: 16 V DC detection (voltage supplied by PCB)	Preferential kWh rate power supply contact: 16 V DC detection (voltage supplied by PCB)
SWB	Switch box
Use normal kWh rate power supply for indoor unit	Use normal kWh rate power supply for indoor unit

English	Translation
(2) Backup heater power supply	(2) Backup heater power supply
Only for ***	Only for ***
(3) User interface	(3) User interface
Only for LAN adapter	Only for the LAN adapter
Only for remote user interface EKRUDAS	Only for the user interface used as room thermostat (EKRUDAS)
(4) Domestic hot water tank	(4) Domestic hot water tank
3 wire type SPST	3 wire type SPST
Booster heater power supply	Booster heater power supply
Only for ***	Only for ***
SWB	Switch box
(5) Ext. thermistor	(5) External thermistor
SWB	Switch box
(6) Field supplied options	(6) Field supplied options
12 V DC pulse detection (voltage supplied by PCB)	12 V DC pulse detection (voltage supplied by PCB)
230 V AC supplied by PCB	230 V AC supplied by PCB
Continuous	Continuous current
DHW pump output	Domestic hot water pump output
DHW pump	Domestic hot water pump
Electrical meters	Electricity meters
For safety thermostat	For safety thermostat
Inrush	Inrush current
Max. load	Maximum load
Normally closed	Normally closed
Normally open	Normally open
Safety thermostat contact: 16 V DC detection (voltage supplied by PCB)	Safety thermostat contact: 16 V DC detection (voltage supplied by PCB)
Shut-off valve	Shut-off valve
SWB	Switch box
(7) Option PCBs	(7) Option PCBs
Alarm output	Alarm output
Changeover to ext. heat source	Changeover to external heat source
Max. load	Maximum load
Min. load	Minimum load
Only for demand PCB option	Only for demand PCB option
Only for digital I/O PCB option	Only for digital I/O PCB option

English	Translation
Options: ext. heat source output, solar pump connection, alarm output	Options: external heat source output, solar pump connection, alarm output
Options: On/OFF output	Options: On/OFF output
Power limitation digital inputs: 12 V DC / 12 mA detection (voltage supplied by PCB)	Power limitation digital inputs: 12 V DC / 12 mA detection (voltage supplied by PCB)
Refer to operation manual	Refer to operation manual
Solar input	Solar input
Solar pump connection	Solar pump connection
Space C/H On/OFF output	Space cooling/heating On/OFF output
SWB	Switch box
(8) External On/OFF thermostats and heat pump convector	(8) External On/OFF thermostats and heat pump convector
Additional LWT zone	Additional leaving water temperature zone
Main LWT zone	Main leaving water temperature zone
Only for external sensor (floor/ambient)	Only for external sensor (floor or ambient)
Only for heat pump convector	Only for heat pump convector
Only for wired On/OFF thermostat	Only for wired On/OFF thermostat
Only for wireless On/OFF thermostat	Only for wireless On/OFF thermostat

Electrical connection diagram

For more details, please check the unit wiring.

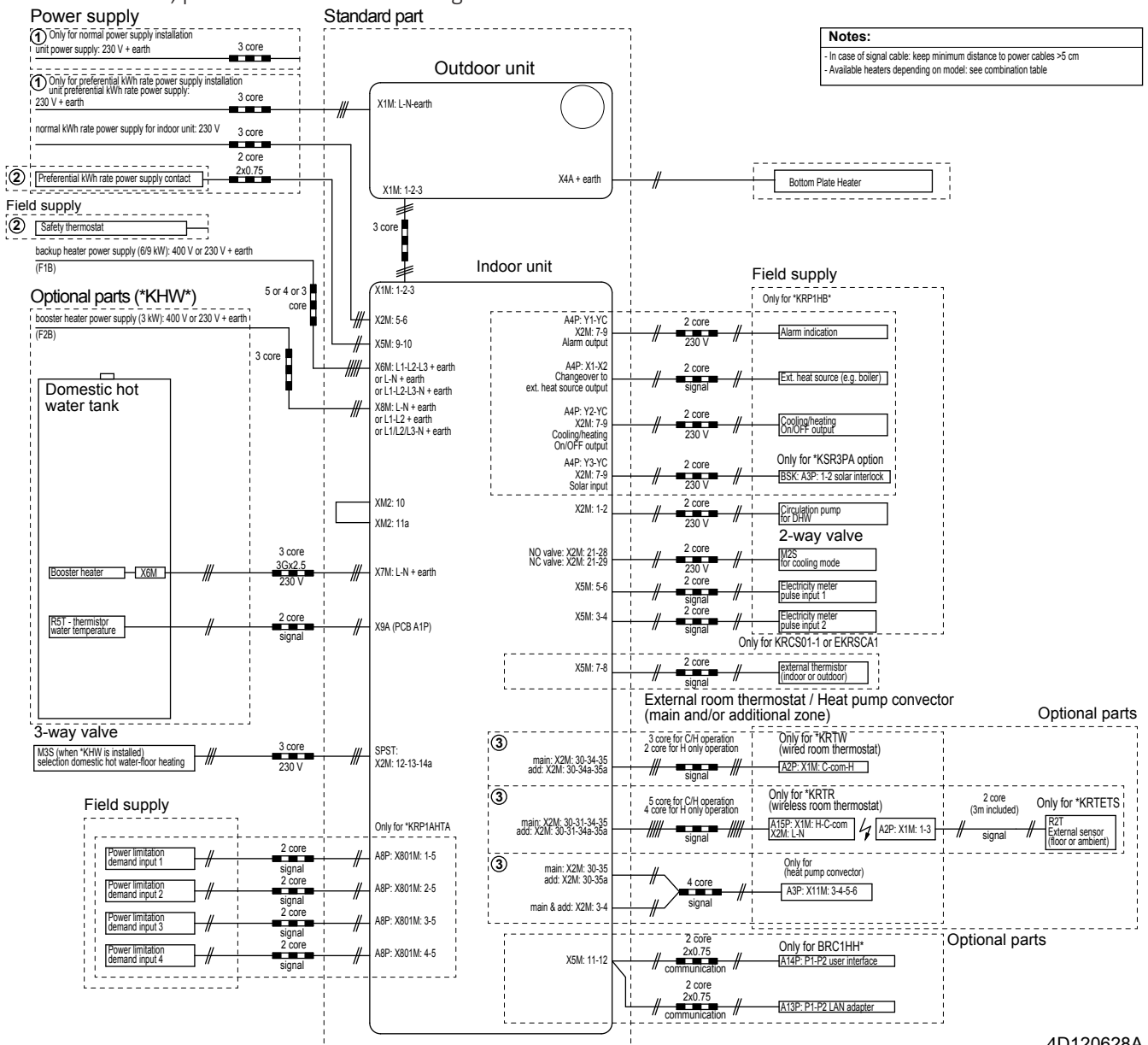

4D120628A

16.6 ESP curve: Indoor unit

Note: A flow error will occur when the minimum water flow rate is not reached.

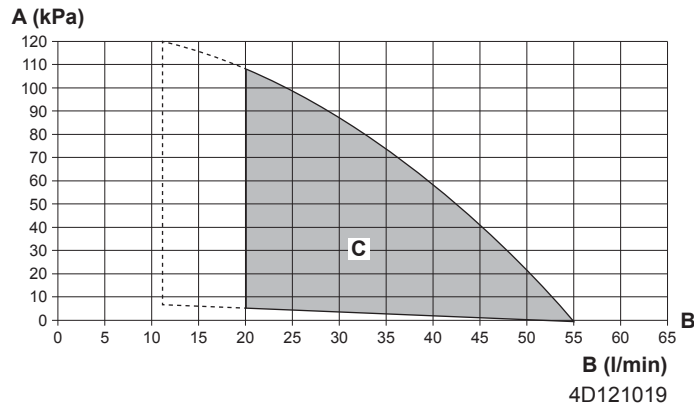

- A** External static pressure in the space heating/cooling circuit
- B** Water flow rate through the unit in the space heating/cooling circuit
- C** Operation range

Dashed lines: Operation area is extended to lower flow rates only in case the unit operates with heat pump only. (Not in startup, no backup heater operation, no defrost operation.)

Notes:

- Selecting a flow outside the operating area can damage the unit or cause the unit to malfunction. See also the minimum and maximum allowed water flow range in the technical specifications.
- Make sure water quality complies with EU directive 2020/2184.

17 Glossary

Dealer

Sales distributor for the product.

Authorised installer

Technical skilled person who is qualified to install the product.

User

Person who is owner of the product and/or operates the product.

Applicable legislation

All international, European, national and local directives, laws, regulations and/or codes that are relevant and applicable for a certain product or domain.

Service company

Qualified company which can perform or coordinate the required service to the product.

Installation manual

Instruction manual specified for a certain product or application, explaining how to install, configure and maintain it.

Operation manual

Instruction manual specified for a certain product or application, explaining how to operate it.

Maintenance instructions

Instruction manual specified for a certain product or application, which explains (if relevant) how to install, configure, operate and/or maintain the product or application.

Accessories

Labels, manuals, information sheets and equipment that are delivered with the product and that need to be installed according to the instructions in the accompanying documentation.

Optional equipment

Equipment made or approved by Daikin that can be combined with the product according to the instructions in the accompanying documentation.

Field supply

Equipment NOT made by Daikin that can be combined with the product according to the instructions in the accompanying documentation.

Field settings table[8.7.5] = **8291**[8.7.5] = **8293****Applicable indoor units**[8.7.5] = **8291**

EABH16DF6V
 EABH16DF9W
 EABX16DF6V
 EABX16DF9W
 EAVH16S18DA6V(G)
 EAVH16S23DA6V(G)
 EAVH16SU18DA6V(G)
 EAVH16SU23DA6V(G)
 EAVH16S18DA9W(G)
 EAVH16S23DA9W(G)
 EAVX16S18DA6V(G)
 EAVX16S23DA6V(G)
 EAVX16S18DA9W(G)
 EAVX16S23DA9W(G)

[8.7.5] = **8293**

EABH16DF6V7
 EABH16DF9W7
 EABX16DF6V7
 EABX16DF9W7
 EAVH16S18DA6V7
 EAVH16S23DA6V7
 EAVH16SU18DA6V7
 EAVH16SU23DA6V7
 EAVH16S18DA9W7
 EAVH16S23DA9W7
 EAVX16S18DA6V7
 EAVX16S23DA6V7
 EAVX16S18DA9W7
 EAVX16S23DA9W7

Notes

- (*1) *6V
- (*2) *9W
- (*3) EAB*
- (*4) EAV*
- (*5) *X*
- (*6) *H*
- (*7) EAV*18*
- (*8) EAV*23*

Field settings table				Installer setting at variance with default value		
Breadcrumb	Field code	Setting name	Range, step	Default value	Date	Value
Room						
└ Antifrost						
1.4.1	[2-06]	Activation	R/W	0: Disabled 1: Enabled		
1.4.2	[2-05]	Room setpoint	R/W	4-16°C, step: 1°C 8°C		
└ Setpoint range						
1.5.1	[3-07]	Heating minimum	R/W	12-18°C, step: 0,5°C 12°C		
1.5.2	[3-06]	Heating maximum	R/W	18-30°C, step: 0,5°C 30°C		
1.5.3	[3-09]	Cooling minimum	R/W	15-25°C, step: 0,5°C 15°C		
1.5.4	[3-08]	Cooling maximum	R/W	25-35°C, step: 0,5°C 35°C		
Room						
1.6	[2-09]	Room sensor offset	R/W	-5-5°C, step: 0,5°C 0°C		
1.7	[2-0A]	Room sensor offset	R/W	-5-5°C, step: 0,5°C 0°C		
Main zone						
2.4		Setpoint mode		0: Fixed 1: WD heating, fixed cooling 2: Weather dependent		
└ Heating WD curve						
2.5	[1-00]	Low ambient temp. for LWT main zone heating WD curve.	R/W	-40-5°C, step: 1°C -10°C		
2.5	[1-01]	High ambient temp. for LWT main zone heating WD curve.	R/W	10-25°C, step: 1°C 15°C		
2.5	[1-02]	Leaving water value for low ambient temp. for LWT main zone heating WD curve.	R/W	[9-01]-[9-00], step: 1°C 35°C		
2.5	[1-03]	Leaving water value for high ambient temp. for LWT main zone heating WD curve.	R/W	[9-01]-min(45, [9-00])°C, step: 1°C 25°C		
└ Cooling WD curve						
2.6	[1-06]	Low ambient temp. for LWT main zone cooling WD curve.	R/W	10-25°C, step: 1°C 20°C		
2.6	[1-07]	High ambient temp. for LWT main zone cooling WD curve.	R/W	25-43°C, step: 1°C 35°C		
2.6	[1-08]	Leaving water value for low ambient temp. for LWT main zone cooling WD curve.	R/W	[9-03]-[9-02]°C, step: 1°C 22°C		
2.6	[1-09]	Leaving water value for high ambient temp. for LWT main zone cooling WD curve.	R/W	[9-03]-[9-02]°C, step: 1°C 18°C		
Main zone						
2.7	[2-0C]	Emitter type	R/W	0: Underfloor heating 1: Fancoil unit 2: Radiator		
└ Setpoint range						
2.8.1	[9-01]	Heating minimum	R/W	15-37°C, step: 1°C 25°C		
2.8.2	[9-00]	Heating maximum	R/W	[2-0C]=2: 37-60, step: 1°C 55°C [2-0C]≠2: 37-55, step: 1°C 55°C		
2.8.3	[9-03]	Cooling minimum	R/W	5-18°C, step: 1°C 8°C		
2.8.4	[9-02]	Cooling maximum	R/W	18-22°C, step: 1°C 22°C		
Main zone						
2.9	[C-07]	Control	R/W	0: LWT control 1: Ext RT control 2: RT control		
2.A	[C-05]	Thermostat type	R/W	0: - 1: 1 contact 2: 2 contacts		
└ Delta T						
2.B.1	[1-0B]	Delta T heating	R/W	3-10°C, step: 1°C 5°C		
2.B.2	[1-0D]	Delta T cooling	R/W	3-10°C, step: 1°C 5°C		
└ Modulation						
2.C.1	[8-05]	Modulation	R/W	0: No 1: Yes		
2.C.2	[8-06]	Max modulation	R/W	0-10°C, step: 1°C 5°C		
└ Shut off valve						
2.D.1	[F-0B]	During thermo	R/W	0: No 1: Yes		
2.D.2	[F-0C]	During cooling	R/W	0: No 1: Yes		
Additional zone						
3.4		Setpoint mode		0: Fixed 1: WD heating, fixed cooling 2: Weather dependent		
└ Heating WD curve						
3.5	[0-00]	Leaving water value for high ambient temp. for LWT add zone heating WD curve.	R/W	[9-05]-min(45, [9-06])°C, step: 1°C 35°C		
3.5	[0-01]	Leaving water value for low ambient temp. for LWT add zone heating WD curve.	R/W	[9-05]-[9-06]°C, step: 1°C 50°C		
3.5	[0-02]	High ambient temp. for LWT add zone heating WD curve.	R/W	10-25°C, step: 1°C 15°C		
3.5	[0-03]	Low ambient temp. for LWT add zone heating WD curve.	R/W	-40-5°C, step: 1°C -10°C		
└ Cooling WD curve						
3.6	[0-04]	Leaving water value for high ambient temp. for LWT add zone cooling WD curve.	R/W	[9-07]-[9-08]°C, step: 1°C 8°C		
3.6	[0-05]	Leaving water value for low ambient temp. for LWT add zone cooling WD curve.	R/W	[9-07]-[9-08]°C, step: 1°C 12°C		
3.6	[0-06]	High ambient temp. for LWT add zone cooling WD curve.	R/W	25-43°C, step: 1°C 35°C		
3.6	[0-07]	Low ambient temp. for LWT add zone cooling WD curve.	R/W	10-25°C, step: 1°C 20°C		

(*1) *6V_(*2) *9W_
 (*3) EAB*_(*4) EAV*_
 (*5) *X*_(*6) *H*_
 (*7) EAV*18*_(*8) EAV*23*

Field settings table				Installer setting at variance with default value		
Breadcrumb	Field code	Setting name	Range, step	Default value	Date	Value
Additional zone						
3.7	[2-0D]	Emitter type	R/W	0: Underfloor heating 1: Fancoil unit 2: Radiator		
Setpoint range						
3.8.1	[9-05]	Heating minimum	R/W	15~37°C, step: 1°C 25°C		
3.8.2	[9-06]	Heating maximum	R/W	[2-0D]=2: 37~60, step: 1°C 55°C [2-0D]≠2: 37~55, step: 1°C 55°C		
3.8.3	[9-07]	Cooling minimum	R/W	5~18°C, step: 1°C 8°C		
3.8.4	[9-08]	Cooling maximum	R/W	18~22°C, step: 1°C 22°C		
Additional zone						
3.A	[C-06]	Thermostat type	R/W	0: - 1: 1 contact 2: 2 contacts		
Delta T						
3.B.1	[1-0C]	Delta T heating	R/W	3~10°C, step: 1°C 5°C		
3.B.2	[1-0E]	Delta T cooling	R/W	3~10°C, step: 1°C 5°C		
Space heating / cooling						
Operation range						
4.3.1	[4-02]	Space heating OFF temp	R/W	14~35°C, step: 1°C 35°C		
4.3.2	[F-01]	Space cooling OFF temp	R/W	10~35°C, step: 1°C 20°C		
Space heating / cooling						
4.4	[7-02]	Number of zones	R/W	0: 1 LWT zone 1: 2 LWT zones		
4.5	[F-0D]	Pump operation mode	R/W	0: Continuous 1: Sample 2: Request		
4.6	[E-02]	Unit type	R/W (*5) R/O (*6)	0: Reversible (*5) 1: Heating only (*6)		
4.7	[9-0D]	Pump speed limitation	R/W	0~8, step:1 0: No limitation 1~4: 90~60% pump speed 5~8: 90~60% pump speed during sampling 6		
Space heating / cooling						
4.9	[F-00]	Pump outside range	R/W	0: Restricted 1: Allowed		
4.A	[D-03]	Increase around 0°C	R/W	0: No 1: increase 2°C, span 4°C 2: increase 4°C, span 4°C 3: increase 2°C, span 8°C 4: increase 4°C, span 8°C		
4.B	[9-04]	Overshoot	R/W	1~4°C, step: 1°C 1°C		
4.C	[2-06]	Antifrost	R/W	0: Disabled 1: Enabled		
Tank						
5.2	[6-0A]	Comfort setpoint	R/W	30~[6-0E]°C, step: 1°C 60°C		
5.3	[6-0B]	Eco setpoint	R/W	30~min(50, [6-0E])°C, step: 1°C 45°C		
5.4	[6-0C]	Reheat setpoint	R/W	30~min(50, [6-0E])°C, step: 1°C 45°C		
5.6	[6-0D]	Heat up mode	R/W	0: Reheat only 1: Reheat + sched. 2: Scheduled only		
Disinfection						
5.7.1	[2-01]	Activation	R/W	0: No 1: Yes		
5.7.2	[2-00]	Operation day	R/W	0: Each day 1: Monday 2: Tuesday 3: Wednesday 4: Thursday 5: Friday 6: Saturday 7: Sunday		
5.7.3	[2-02]	Start time	R/W	0~23 hour, step: 1 hour 1		
5.7.4	[2-03]	Tank setpoint	R/W	[E-07]≠1 : 55~75°C, step: 5°C 70°C [E-07]=1 : 60°C 60°C		
5.7.5	[2-04]	Duration	R/W	[E-07]≠1: 5~60 min, step: 5 min 10 min [E-07]=1: 40~60 min, step: 5 min 40 min		
Tank						
5.8	[6-0E]	Maximum	R/W	(*3) : 40~75°C, step: 1°C 60°C [E-07]=0 (*3) : 40~80°C, step: 1°C 80°C [E-07]=5 (*4) : 40~60°C, step: 1°C 60°C		
5.9	[6-00]	Hysteresis	R/W	2~40°C, step: 1°C 28°C (*7) 22°C (*8) 20°C (*3)		
5.A	[6-08]	Hysteresis	R/W	2~20°C, step: 1°C 10°C		

(*1) *6V_(*2) *9W_
 (*3) EAB*_(*4) EAV*_
 (*5) *X*_(*6) *H*_
 (*7) EAV*18*_(*8) EAV*23*

(#) Setting is not applicable for this unit.

4P556072-1C - 2021.02

Field settings table				Installer setting at variance with default value		
Breadcrumb	Field code	Setting name	Range, step	Default value	Date	Value
5.B		Setpoint mode	R/W	0: Fixed 1: Weather dependent		
└─ WD curve						
5.C	[0-0B]	Leaving water value for high ambient temp. for DHW WD curve.	R/W	35-[6-0E]°C, step: 1°C 55°C		
5.C	[0-0C]	Leaving water value for low ambient temp. for DHW WD curve.	R/W	45-[6-0E]°C, step: 1°C 60°C		
5.C	[0-0D]	High ambient temp. for DHW WD curve.	R/W	10-25°C, step: 1°C 15°C		
5.C	[0-0E]	Low ambient temp. for DHW WD curve.	R/W	-40-5°C, step: 1°C -10°C		
Tank						
5.D	[6-01]	Margin	R/W	0-10°C, step: 1°C 2°C		
User settings						
└─ Quiet						
7.4.1		Activation	R/W	0: OFF 1: Quiet 2: More quiet 3: Most quiet 4: Automatic		
└─ Electricity price						
7.5.1		High	R/W	0,00-990/kWh 1/kWh		
7.5.2		Medium	R/W	0,00-990/kWh 1/kWh		
7.5.3		Low	R/W	0,00-990/kWh 1/kWh		
User settings						
7.6		Gas price	R/W	0,00-990/kWh 0,00-290/MBtu 1,0/kWh		
Installer settings						
└─ Configuration wizard						
└─ System						
9.1	[E-03]	BUH type	R/O	3: 6V (*1) 4: 9W (*2)		
9.1	[E-05] [E-06] [E-07]	Domestic hot water	R/W	No DHW (*3) EKHW (*3) Integrated (*4) EKHWP (*3)		
9.1	[4-06]	Emergency	R/W	0: Manual 1: Automatic		
9.1	[7-02]	Number of zones	R/W	0: Single zone 1: Dual zone		
└─ Backup heater						
9.1	[5-0D]	Voltage	R/W (*1) R/O (*2)	0: 230V, 1- (*1) 1: 230V, 3- (*1) 2: 400V, 3- (*2)		
9.1	[4-0A]	Configuration	R/W	1: 1/1+2 (*1) (*2) 2: 1/2 3: 1/2 + 1/1+2 in emergency		
9.1	[6-03]	Capacity step 1	R/W	0-10kW, step: 0,2kW 2kW (*1) 3kW (*2)		
9.1	[6-04]	Additional capacity step 2	R/W	0-10kW, step: 0,2kW 4kW (*1) 6kW (*2)		
└─ Main zone						
9.1	[2-0C]	Emitter type	R/W	0: Underfloor heating 1: Fancoil unit 2: Radiator		
9.1	[C-07]	Control	R/W	0: LWT control 1: Ext RT control 2: RT control		
9.1		Setpoint mode	R/W	0: Fixed 1: WD heating, fixed cooling 2: Weather dependent		
9.1		Schedule	R/W	0: No 1: Yes		
9.1	[1-00]	Low ambient temp. for LWT main zone heating WD curve.	R/W	-40-5°C, step: 1°C -10°C		
9.1	[1-01]	High ambient temp. for LWT main zone heating WD curve.	R/W	10-25°C, step: 1°C 15°C		
9.1	[1-02]	Leaving water value for low ambient temp. for LWT main zone heating WD curve.	R/W	[9-01]-[9-00], step: 1°C 35°C		
9.1	[1-03]	Leaving water value for high ambient temp. for LWT main zone heating WD curve.	R/W	[9-01]-min(45,[9-00])°C, step: 1°C 25°C		
9.1	[1-06]	Low ambient temp. for LWT main zone cooling WD curve.	R/W	10-25°C, step: 1°C 20°C		
9.1	[1-07]	High ambient temp. for LWT main zone cooling WD curve.	R/W	25-43°C, step: 1°C 35°C		
9.1	[1-08]	Leaving water value for low ambient temp. for LWT main zone cooling WD curve.	R/W	[9-03]-[9-02]°C, step: 1°C 22°C		
9.1	[1-09]	Leaving water value for high ambient temp. for LWT main zone cooling WD curve.	R/W	[9-03]-[9-02]°C, step: 1°C 18°C		
└─ Additional zone						
9.1	[2-0D]	Emitter type	R/W	0: Underfloor heating 1: Fancoil unit 2: Radiator		
9.1		Setpoint mode	R/W	0: Fixed 1: WD heating, fixed cooling 2: Weather dependent		
9.1		Schedule	R/W	0: No 1: Yes		
9.1	[0-00]	Leaving water value for high ambient temp. for LWT add zone heating WD curve.	R/W	[9-05]-min(45,[9-06])°C, step: 1°C 35°C		
9.1	[0-01]	Leaving water value for low ambient temp. for LWT add zone heating WD curve.	R/W	[9-05]-[9-06]°C, step: 1°C 50°C		
9.1	[0-02]	High ambient temp. for LWT add zone heating WD curve.	R/W	10-25°C, step: 1°C 15°C		
9.1	[0-03]	Low ambient temp. for LWT add zone heating WD curve.	R/W	-40-5°C, step: 1°C -10°C		

(*1) *6V_(*2) *9W_
(*3) EAB*_(*4) EAV*_

(*5) *X*_(*6) *H*_

(*7) EAV*18*_(*8) EAV*23*

Field settings table				Installer setting at variance with default value		
Breadcrumb	Field code	Setting name	Range, step	Default value	Date	Value
	9.1	[0-04] Leaving water value for high ambient temp. for LWT add zone cooling WD curve.	R/W	[9-07]-[9-08]°C, step: 1°C 8°C		
	9.1	[0-05] Leaving water value for low ambient temp. for LWT add zone cooling WD curve.	R/W	[9-07]-[9-08]°C, step: 1°C 12°C		
	9.1	[0-06] High ambient temp. for LWT add zone cooling WD curve.	R/W	25-43°C, step: 1°C 35°C		
	9.1	[0-07] Low ambient temp. for LWT add zone cooling WD curve.	R/W	10-25°C, step: 1°C 20°C		
└ Tank						
	9.1	[6-0D] Heat up mode	R/W	0: Reheat only 1: Reheat + sched. 2: Scheduled only		
	9.1	[6-0A] Comfort setpoint	R/W	30-[6-0E]°C, step: 1°C 60°C		
	9.1	[6-0B] Eco setpoint	R/W	30-min(50, [6-0E])°C, step: 1°C 45°C		
	9.1	[6-0C] Reheat setpoint	R/W	30-min(50, [6-0E])°C, step: 1°C 45°C		
└ Domestic hot water						
	9.2.1	[E-05] Domestic hot water [E-06] [E-07]	R/W	No DHW (*3) EKHW (*3) Integrated (*4) EKHWP (*3)		
	9.2.2	[D-02] DHW pump	R/W	0: No 1: Secondary rtn 2: Disinf. Shunt		
	9.2.4	[D-07] Solar	R/W	0: No 1: Yes		
└ Back up heater						
	9.3.1	[E-03] BUH type	R/O	3: 6V (*1) 4: 9W (*2)		
	9.3.2	[5-0D] Voltage	R/W (*1) R/O (*2)	0: 230V, 1- (*1) 1: 230V, 3- (*1) 2: 400V, 3- (*2)		
	9.3.3	[4-0A] Configuration	R/W	1: 1/1+2 (*1) (*2) 2: 1/2 3: 1/2 + 1/1+2 in emergency		
	9.3.4	[6-03] Capacity step 1	R/W	0-10kW, step: 0,2kW 2kW (*1) 3kW (*2)		
	9.3.5	[6-04] Additional capacity step 2	R/W	0-10kW, step: 0,2kW 4kW (*1) 6kW (*2)		
	9.3.6	[5-00] Equilibrium: Deactivate backup heater (or external backup heat source in case of a bivalent system) above the equilibrium temperature for space heating?	R/W	0: No 1: Yes		
	9.3.7	[5-01] Equilibrium temperature	R/W	-15-35°C, step: 1°C 0°C		
	9.3.8	[4-00] Operation	R/W	0: Disabled 1: Enabled 2: Only DHW		
└ Booster heater						
	9.4.1	[6-02] Capacity	R/W	0-10kW, step: 0,2kW 3kW (*3) 0kW (*4)		
	9.4.3	[8-03] BSH eco timer	R/W	20-95 min, step: 5 min 50 min		
	9.4.4	[4-03] Operation	R/W	0: Restricted 1: Allowed 2: Overlap 3: Compressor off 4: Legionella only		
Installer settings						
	9.5	[4-06] Emergency	R/W	0: Manual 1: Automatic		
└ Balancing						
	9.6.1	[5-02] Space heating priority	R/W	0: Disabled 1: Enabled		
	9.6.2	[5-03] Priority temperature	R/W	-15-35°C, step: 1°C 0°C		
	9.6.3	[5-04] Offset BSH setpoint	R/W	0-20°C, step: 1°C 10°C		
	9.6.4	[8-02] Anti-recycle timer	R/W	0-10 hour, step: 0,5 hour 0,5 hour [E-07]=1 3 hour [E-07]#1		
	9.6.5	[8-00] Minimum running timer	R/O	0-20 min, step 1 min 1 min		
	9.6.6	[8-01] Maximum running timer	R/W	5-95 min, step: 5 min 30 min		
	9.6.7	[8-04] Additional timer	R/W	0-95 min, step: 5 min 95 min		
Installer settings						
	9.7	[4-04] Water pipe freeze prevention	R/O	0: Intermittent		
└ Benefit kWh power supply						
	9.8.1	[D-01] Benefit kWh power supply	R/W	0: No 1: Active open 2: Active closed 3: Safety thermostat		
	9.8.2	[D-00] Allow heater	R/W	0: None 1: BSH only 2: BUH only 3: All heaters		
	9.8.3	[D-05] Allow pump	R/W	0: Forced off 1: As normal		
└ Power consumption control						
	9.9.1	[4-08] Power consumption control	R/W	0: No limitation 1: Continuous 2: Digital inputs		
	9.9.2	[4-09] Type	R/W	0: Current 1: Power		
	9.9.3	[5-05] Limit	R/W	0-50 A, step: 1 A 50 A		

(*1) *6V_(*2) *9W_
 (*3) EAB*_(*4) EAV*_
 (*5) *X*_(*6) *H*_
 (*7) EAV*18*_(*8) EAV*23*

(#) Setting is not applicable for this unit.

4P556072-1C - 2021.02

Field settings table				Installer setting at variance with default value		
Breadcrumb	Field code	Setting name	Range, step	Default value	Date	Value
9.9.4	[5-05]	Limit 1	R/W	0-50 A, step: 1 A 50 A		
9.9.5	[5-06]	Limit 2	R/W	0-50 A, step: 1 A 50 A		
9.9.6	[5-07]	Limit 3	R/W	0-50 A, step: 1 A 50 A		
9.9.7	[5-08]	Limit 4	R/W	0-50 A, step: 1 A 50 A		
9.9.8	[5-09]	Limit	R/W	0-20 kW, step: 0,5 kW 20 kW		
9.9.9	[5-09]	Limit 1	R/W	0-20 kW, step: 0,5 kW 20 kW		
9.9.A	[5-0A]	Limit 2	R/W	0-20 kW, step: 0,5 kW 20 kW		
9.9.B	[5-0B]	Limit 3	R/W	0-20 kW, step: 0,5 kW 20 kW		
9.9.C	[5-0C]	Limit 4	R/W	0-20 kW, step: 0,5 kW 20 kW		
9.9.D	[4-01]	Priority heater		0: None 1: BSH 2: BUH		
Energy metering						
9.A.1	[D-08]	Electricity meter 1	R/W	0: No 1: 0,1 pulse/kWh 2: 1 pulse/kWh 3: 10 pulse/kWh 4: 100 pulse/kWh 5: 1000 pulse/kWh		
9.A.2	[D-09]	Electricity meter 2	R/W	0: No 1: 0,1 pulse/kWh 2: 1 pulse/kWh 3: 10 pulse/kWh 4: 100 pulse/kWh 5: 1000 pulse/kWh		
Sensors						
9.B.1	[C-08]	External sensor	R/W	0: No 1: Outdoor sensor 2: Room sensor		
9.B.2	[2-0B]	Ext. amb. sensor offset	R/W	-5-5°C, step: 0,5°C 0°C		
9.B.3	[1-0A]	Averaging time	R/W	0: No averaging 1: 12 hours 2: 24 hours 3: 48 hours 4: 72 hours		
Bivalent						
9.C.1	[C-02]	Bivalent	R/W	0: No 1: Bivalent		
9.C.2	[7-05]	Boiler efficiency	R/W	0: Very high 1: High 2: Medium 3: Low 4: Very low		
9.C.3	[C-03]	Temperature	R/W	-25-25°C, step: 1°C 0°C		
9.C.4	[C-04]	Hysteresis	R/W	2-10°C, step 1°C 3°C		
Installer settings						
9.D	[C-09]	Alarm output	R/W	0: Normally open 1: Normally closed		
9.E	[3-00]	Auto restart	R/W	0: No 1: Yes		
9.F	[E-08]	Power saving function	R/O	0: disabled 1: Enabled		
9.G		Disable protections	R/W	0: No 1: Yes		
Overview field settings						
9.I	[0-00]	Leaving water value for high ambient temp. for LWT add zone heating WD curve.	R/W	[9-05]-min(45,[9-06])°C, step: 1°C 35°C		
9.I	[0-01]	Leaving water value for low ambient temp. for LWT add zone heating WD curve.	R/W	[9-05]-[9-06]°C, step: 1°C 50°C		
9.I	[0-02]	High ambient temp. for LWT add zone heating WD curve.	R/W	10-25°C, step: 1°C 15°C		
9.I	[0-03]	Low ambient temp. for LWT add zone heating WD curve.	R/W	-40-5°C, step: 1°C -10°C		
9.I	[0-04]	Leaving water value for high ambient temp. for LWT add zone cooling WD curve.	R/W	[9-07]-[9-08]°C, step: 1°C 8°C		
9.I	[0-05]	Leaving water value for low ambient temp. for LWT add zone cooling WD curve.	R/W	[9-07]-[9-08]°C, step: 1°C 12°C		
9.I	[0-06]	High ambient temp. for LWT add zone cooling WD curve.	R/W	25-43°C, step: 1°C 35°C		
9.I	[0-07]	Low ambient temp. for LWT add zone cooling WD curve.	R/W	10-25°C, step: 1°C 20°C		
9.I	[0-0B]	Leaving water value for high ambient temp. for DHW WD curve.	R/W	35-[6-0E]°C, step: 1°C 55°C		
9.I	[0-0C]	Leaving water value for low ambient temp. for DHW WD curve.	R/W	45-[6-0E]°C, step: 1°C 60°C		
9.I	[0-0D]	High ambient temp. for DHW WD curve.	R/W	10-25°C, step: 1°C 15°C		
9.I	[0-0E]	Low ambient temp. for DHW WD curve.	R/W	-40-5°C, step: 1°C -10°C		
9.I	[1-00]	Low ambient temp. for LWT main zone heating WD curve.	R/W	-40-5°C, step: 1°C -10°C		
9.I	[1-01]	High ambient temp. for LWT main zone heating WD curve.	R/W	10-25°C, step: 1°C 15°C		
9.I	[1-02]	Leaving water value for low ambient temp. for LWT main zone heating WD curve.	R/W	[9-01]-[9-00], step: 1°C 35°C		
9.I	[1-03]	Leaving water value for high ambient temp. for LWT main zone heating WD curve.	R/W	[9-01]-min(45, [9-00])°C, step: 1°C 25°C		
9.I	[1-04]	Weather dependent cooling of the main leaving water temperature zone.	R/W	0: Disabled 1: Enabled		
9.I	[1-05]	Weather dependent cooling of the additional leaving water temperature zone	R/W	0: Disabled 1: Enabled		

(*1) *6V_(*) *9W_
 (*3) EAB*_(*)4 EAV*_
 (*5) *X*_(*)6 *H*_
 (*7) EAV*18*_(*)8 EAV*23*

Field settings table				Installer setting at variance with default value		
Breadcrumb	Field code	Setting name	Range, step	Default value	Date	Value
	9.1	[1-06]	Low ambient temp. for LWT main zone cooling WD curve.	R/W	10~25°C, step: 1°C 20°C	
	9.1	[1-07]	High ambient temp. for LWT main zone cooling WD curve.	R/W	25~43°C, step: 1°C 35°C	
	9.1	[1-08]	Leaving water value for low ambient temp. for LWT main zone cooling WD curve.	R/W	[9-03]~[9-02]°C, step: 1°C 22°C	
	9.1	[1-09]	Leaving water value for high ambient temp. for LWT main zone cooling WD curve.	R/W	[9-03]~[9-02]°C, step: 1°C 18°C	
	9.1	[1-0A]	What is the averaging time for the outdoor temp?	R/W	0: No averaging 1: 12 hours 2: 24 hours 3: 48 hours 4: 72 hours	
	9.1	[1-0B]	What is the desired delta T in heating for the main zone?	R/W	3~10°C, step: 1°C 5°C	
	9.1	[1-0C]	What is the desired delta T in heating for the additional zone?	R/W	3~10°C, step: 1°C 5°C	
	9.1	[1-0D]	What is the desired delta T in cooling for the main zone?	R/W	3~10°C, step: 1°C 5°C	
	9.1	[1-0E]	What is the desired delta T in cooling for the additional zone?	R/W	3~10°C, step: 1°C 5°C	
	9.1	[2-00]	When should the disinfection function be executed?	R/W	0: Each day 1: Monday 2: Tuesday 3: Wednesday 4: Thursday 5: Friday 6: Saturday 7: Sunday	
	9.1	[2-01]	Should the disinfection function be executed?	R/W	0: No 1: Yes	
	9.1	[2-02]	When should the disinfection function start?	R/W	0~23 hour, step: 1 hour 1	
	9.1	[2-03]	What is the disinfection target temperature?	R/W	[E-07]≠1 : 55~75°C, step: 5°C 70°C [E-07]=1 : 60°C 60°C	
	9.1	[2-04]	How long must the tank temperature be maintained?	R/W	[E-07]≠1: 5~60 min, step: 5 min 10 min [E-07]=1: 40~60 min, step: 5 min 40 min	
	9.1	[2-05]	Room antifrost temperature	R/W	4~16°C, step: 1°C 8°C	
	9.1	[2-06]	Room frost protection	R/W	0: Disabled 1: Enabled	
	9.1	[2-09]	Adjust the offset on the measured room temperature	R/W	-5~5°C, step: 0.5°C 0°C	
	9.1	[2-0A]	Adjust the offset on the measured room temperature	R/W	-5~5°C, step: 0.5°C 0°C	
	9.1	[2-0B]	What is the required offset on the measured outdoor temp.?	R/W	-5~5°C, step: 0.5°C 0°C	
	9.1	[2-0C]	What emitter type is connected to the main LWT zone?	R/W	0: Underfloor heating 1: Fancoil unit 2: Radiator	
	9.1	[2-0D]	What emitter type is connected to the additional LWT zone?	R/W	0: Underfloor heating 1: Fancoil unit 2: Radiator	
	9.1	[2-0E]	What is the maximum allowed current over the heatpump ?	R/W	20~50 A, step: 1 A 50 A	
	9.1	[3-00]	Is auto restart of the unit allowed?	R/W	0: No 1: Yes	
	9.1	[3-01]	--		0	
	9.1	[3-02]	--		1	
	9.1	[3-03]	--		4	
	9.1	[3-04]	--		2	
	9.1	[3-05]	--		1	
	9.1	[3-06]	What is the maximum desired room temperature in heating?	R/W	18~30°C, step: 0.5°C 30°C	
	9.1	[3-07]	What is the minimum desired room temperature in heating?	R/W	12~18°C, step: 0.5°C 12°C	
	9.1	[3-08]	What is the maximum desired room temperature in cooling?	R/W	25~35°C, step: 0.5°C 35°C	
	9.1	[3-09]	What is the minimum desired room temperature in cooling?	R/W	15~25°C, step: 0.5°C 15°C	
	9.1	[4-00]	What is the BUH operation mode?	R/W	0: Disabled 1: Enabled 2: Only DHW	
	9.1	[4-01]	Which electric heater has priority?	R/W	0: None 1: BSH 2: BUH	
	9.1	[4-02]	Below which outdoor temperature is heating allowed?	R/W	14~35°C, step: 1°C 35°C	
	9.1	[4-03]	Operation permission of the booster heater.	R/W	0: Restricted 1: Allowed 2: Overlap 3: Compressor off 4: Legionella only	
	9.1	[4-04]	Water pipe freeze prevention	R/O	0: Intermittent	
	9.1	[4-05]	--		0	
	9.1	[4-06]	Emergency	R/W	0: Manual 1: Automatic	
	9.1	[4-08]	Which power limitation mode is required on the system?	R/W	0: No limitation 1: Continuous 2: Digital inputs	
	9.1	[4-09]	Which power limitation type is required?	R/W	0: Current 1: Power	
	9.1	[4-0A]	Backup heater configuration	R/W	1: 1/1+2 (*1) (*2) 2: 1/2 3: 1/2 + 1/1+2 in emergency	
	9.1	[4-0B]	Automatic cooling/heating changeover hysteresis.	R/W	1~10°C, step: 0.5°C 1°C	
	9.1	[4-0D]	Automatic cooling/heating changeover offset.	R/W	1~10°C, step: 0.5°C 3°C	

(*1) *6V_(*2) *9W_
 (*3) EAB*_(*4) EAV*_
 (*5) *X*_(*6) *H*_
 (*7) EAV*18*_(*8) EAV*23*

(#) Setting is not applicable for this unit.

4P556072-1C - 2021.02

Field settings table				Installer setting at variance with default value		
Breadcrumb	Field code	Setting name	Range, step	Default value	Date	Value
9.1	[5-00]	Equilibrium: Deactivate backup heater (or external backup heat source in case of a bivalent system) above the equilibrium temperature for space heating?	R/W	0: No 1: Yes		
9.1	[5-01]	What is the equilibrium temperature for the building?	R/W	-15~35°C, step: 1°C 0°C		
9.1	[5-02]	Space heating priority.	R/W	0: Disabled 1: Enabled		
9.1	[5-03]	Space heating priority temperature.	R/W	-15~35°C, step: 1°C 0°C		
9.1	[5-04]	Set point correction for domestic hot water temperature.	R/W	0~20°C, step: 1°C 10°C		
9.1	[5-05]	What is the requested limit for DI1?	R/W	0~50 A, step: 1 A 50 A		
9.1	[5-06]	What is the requested limit for DI2?	R/W	0~50 A, step: 1 A 50 A		
9.1	[5-07]	What is the requested limit for DI3?	R/W	0~50 A, step: 1 A 50 A		
9.1	[5-08]	What is the requested limit for DI4?	R/W	0~50 A, step: 1 A 50 A		
9.1	[5-09]	What is the requested limit for DI1?	R/W	0~20 kW, step: 0,5 kW 20 kW		
9.1	[5-0A]	What is the requested limit for DI2?	R/W	0~20 kW, step: 0,5 kW 20 kW		
9.1	[5-0B]	What is the requested limit for DI3?	R/W	0~20 kW, step: 0,5 kW 20 kW		
9.1	[5-0C]	What is the requested limit for DI4?	R/W	0~20 kW, step: 0,5 kW 20 kW		
9.1	[5-0D]	Backup heater voltage	R/W (*1) R/O (*2)	0: 230V, 1~ (*1) 1: 230V, 3~ (*1) 2: 400V, 3~ (*2)		
9.1	[5-0E]	--		1		
9.1	[6-00]	The temperature difference determining the heat pump ON temperature.	R/W	2~40°C, step: 1°C 28°C (*7) 22°C (*8) 20°C (*3)		
9.1	[6-01]	The temperature difference determining the heat pump OFF temperature.	R/W	0~10°C, step: 1°C 2°C		
9.1	[6-02]	What is the capacity of the booster heater?	R/W	0~10kW, step: 0,2kW 3kW (*3) 0kW (*4)		
9.1	[6-03]	What is the capacity of the backup heater step 1?	R/W	0~10kW, step: 0,2kW 2kW (*1) 3kW (*2)		
9.1	[6-04]	What is the capacity of the backup heater step 2?	R/W	0~10kW, step: 0,2kW 4kW (*1) 6kW (*2)		
9.1	[6-05]	--		0		
9.1	[6-06]	--		0		
9.1	[6-07]	--		0		
9.1	[6-08]	What is the hysteresis to be used in reheat mode?	R/W	2~20°C, step: 1°C 10°C		
9.1	[6-09]	--		0		
9.1	[6-0A]	What is the desired comfort storage temperature?	R/W	30~[6-0E]°C, step: 1°C 60°C		
9.1	[6-0B]	What is the desired eco storage temperature?	R/W	30~min(50, [6-0E])°C, step: 1°C 45°C		
9.1	[6-0C]	What is the desired reheat temperature?	R/W	30~min(50, [6-0E])°C, step: 1°C 45°C		
9.1	[6-0D]	What is the desired DHW production type?	R/W	0: Reheat only 1: Reheat + sched. 2: Scheduled only		
9.1	[6-0E]	What is the maximum temperature setpoint?	R/W	(*3) : 40~75°C, step: 1°C 60°C [E-07]=0 (*3) : 40~80°C, step: 1°C 80°C [E-07]=5 (*4) : 40~60°C, step: 1°C 60°C		
9.1	[7-00]	Domestic hot water booster heater overshoot temperature.	R/W	0~4°C, step: 1°C 0°C		
9.1	[7-01]	Domestic hot water booster heater hysteresis.	R/W	2~40°C, step: 1°C 2°C		
9.1	[7-02]	How many leaving water temperature zones are there?	R/W	0: 1 LWT zone 1: 2 LWT zones		
9.1	[7-03]	--		2,5		
9.1	[7-04]	--		0		
9.1	[7-05]	Boiler efficiency	R/W	0: Very high 1: High 2: Medium 3: Low 4: Very low		
9.1	[8-00]	Minimum running time for domestic hot water operation.	R/O	0~20 min, step 1 min 1 min		
9.1	[8-01]	Maximum running time for domestic hot water operation.	R/W	5~95 min, step: 5 min 30 min		
9.1	[8-02]	Anti-recycling time.	R/W	0~10 hour, step: 0,5 hour 0,5 hour [E-07]=1 3 hour [E-07]#1		
9.1	[8-03]	Booster heater delay timer.	R/W	20~95 min, step: 5 min 50 min		
9.1	[8-04]	Additional running time for the maximum running time.	R/W	0~95 min, step: 5 min 95 min		
9.1	[8-05]	Allow modulation of the LWT to control the room temp?	R/W	0: No 1: Yes		
9.1	[8-06]	Leaving water temperature maximum modulation.	R/W	0~10°C, step: 1°C 5°C		
9.1	[8-07]	What is the desired comfort main LWT in cooling?	R/W	[9-03]~[9-02], step: 1°C 18°C		
9.1	[8-08]	What is the desired eco main LWT in cooling?	R/W	[9-03]~[9-02], step: 1°C 20°C		
9.1	[8-09]	What is the desired comfort main LWT in heating?	R/W	[9-01]~[9-00], step: 1°C 35°C		
9.1	[8-0A]	What is the desired eco main LWT in heating?	R/W	[9-01]~[9-00], step: 1°C 33°C		

(*1) *6V_(*2) *9W_
(*3) EAB*_(*4) EAV*_

(*5) *X*_(*6) *H*_

(*7) EAV*18*_(*8) EAV*23*

Field settings table				Installer setting at variance with default value	
Breadcrumb	Field code	Setting name	Range, step Default value	Date	Value
9.1	[8-0B]	--	13		
9.1	[8-0C]	--	10		
9.1	[8-0D]	--	16		
9.1	[9-00]	What is the maximum desired LWT for main zone in heating?	R/W [2-0C]=2: 37-60, step: 1°C 55°C [2-0C]≠2: 37-55, step: 1°C 55°C		
9.1	[9-01]	What is the minimum desired LWT for main zone in heating?	R/W 15-37°C, step: 1°C 25°C		
9.1	[9-02]	What is the maximum desired LWT for main zone in cooling?	R/W 18-22°C, step: 1°C 22°C		
9.1	[9-03]	What is the minimum desired LWT for main zone in cooling?	R/W 5-18°C, step: 1°C 8°C		
9.1	[9-04]	Leaving water temperature overshoot temperature.	R/W 1-4°C, step: 1°C 1°C		
9.1	[9-05]	What is the minimum desired LWT for add. zone in heating?	R/W 15-37°C, step: 1°C 25°C		
9.1	[9-06]	What is the maximum desired LWT for add. zone in heating?	R/W [2-0D]=2: 37-60, step: 1°C 55°C [2-0D]≠2: 37-55, step: 1°C 55°C		
9.1	[9-07]	What is the minimum desired LWT for add. zone in cooling?	R/W 5-18°C, step: 1°C 8°C		
9.1	[9-08]	What is the maximum desired LWT for add. zone in cooling?	R/W 18-22°C, step: 1°C 22°C		
9.1	[9-0C]	Room temperature hysteresis.	R/W 1-6°C, step: 0.5°C 1 °C		
9.1	[9-0D]	Pump speed limitation	R/W 0-8, step:1 0: No limitation 1-4: 90-60% pump speed 5-8: 90-60% pump speed during sampling 6		
9.1	[9-0E]	--	6		
9.1	[C-00]	Domestic heating water priority.	R/W 0: Solar priority 1: Heat pump priority		
9.1	[C-01]	--	0		
9.1	[C-02]	Is an external backup heat source connected?	R/W 0: No 1: Bivalent		
9.1	[C-03]	Bivalent activation temperature.	R/W -25-25°C, step: 1°C 0°C		
9.1	[C-04]	Bivalent hysteresis temperature.	R/W 2-10°C, step 1°C 3°C		
9.1	[C-05]	What is the thermo request contact type for the main zone?	R/W 0: - 1: 1 contact 2: 2 contacts		
9.1	[C-06]	What is the thermo request contact type for the add. zone?	R/W 0: - 1: 1 contact 2: 2 contacts		
9.1	[C-07]	What is the unit control method in space operation?	R/W 0: LWT control 1: Ext RT control 2: RT control		
9.1	[C-08]	Which type of external sensor is installed?	R/W 0: No 1: Outdoor sensor 2: Room sensor		
9.1	[C-09]	What is the required alarm output contact type?	R/W 0: Normally open 1: Normally closed		
9.1	[C-0A]	--	0		
9.1	[D-00]	Which heaters are permitted if prefer. kWh rate PS is cut?	R/W 0: None 1: BSH only 2: BUH only 3: All heaters		
9.1	[D-01]	Contact type of preferential kWh rate PS installation?	R/W 0: No 1: Active open 2: Active closed 3: Safety thermostat		
9.1	[D-02]	Which type of DHW pump is installed?	R/W 0: No 1: Secondary rtn 2: Disinf. Shunt		
9.1	[D-03]	Leaving water temperature compensation around 0°C.	R/W 0: No 1: increase 2°C, span 4°C 2: increase 4°C, span 4°C 3: increase 2°C, span 8°C 4: increase 4°C, span 8°C		
9.1	[D-04]	Is a demand PCB connected?	R/W 0: No 1: Pwr consmp ctrl		
9.1	[D-05]	Is the pump allowed to run if prefer. kWh rate PS is cut?	R/W 0: Forced off 1: As normal		
9.1	[D-07]	Is a solar kit connected?	R/W 0: No 1: Yes		
9.1	[D-08]	Is an external kWh meter used for power measurement?	R/W 0: No 1: 0,1 pulse/kWh 2: 1 pulse/kWh 3: 10 pulse/kWh 4: 100 pulse/kWh 5: 1000 pulse/kWh		
9.1	[D-09]	Is an external kWh meter used for power measurement?	R/W 0: No 1: 0,1 pulse/kWh 2: 1 pulse/kWh 3: 10 pulse/kWh 4: 100 pulse/kWh 5: 1000 pulse/kWh		
9.1	[D-0A]	--	0		
9.1	[D-0B]	--	2		
9.1	[E-00]	Which type of unit is installed?	R/O 0-5 0: LT split		
9.1	[E-01]	Which type of compressor is installed?	R/O 1		

(*1) *6V_(*2) *9W_
 (*3) EAB*_(*4) EAV*_
 (*5) *X*_(*6) *H*_
 (*7) EAV*18*_(*8) EAV*23*

(#) Setting is not applicable for this unit.

Field settings table				Installer setting at variance with default value	
Breadcrumb	Field code	Setting name	Range, step Default value	Date	Value
9.1	[E-02]	What is the indoor unit software type?	R/W (*5) R/O (*6) 0: Reversible (*5) 1: Heating only (*6)		
9.1	[E-03]	What is the number of backup heater steps?	R/O 3: 6V (*1) 4: 9W (*2)		
9.1	[E-04]	Is the power saving function available on the outdoor unit?	R/O 0: No 1: Yes		
9.1	[E-05]	Can the system prepare domestic hot water?	R/W 0: No (*3) 1: Yes (*4)		
9.1	[E-06]	Is a DHW tank installed in the system?	R/O 0: No 1: Yes		
9.1	[E-07]	What kind of DHW tank is installed?	R/W 0-6 0: EKHW (*3) 1: Integrated (*4) 5: EKHW (*3)		
9.1	[E-08]	Power saving function for outdoor unit.	R/O 0: disabled 1: Enabled		
9.1	[E-09]	--	1		
9.1	[E-0A]	--	0		
9.1	[E-0B]	Is a bi-zone kit installed?	0		
9.1	[E-0C]	--	0		
9.1	[E-0D]	Is the system filled with glycol ?	R/W 0: No 1: Yes		
9.1	[E-0E]	--	0		
9.1	[F-00]	Pump operation allowed outside range.	R/W 0: Disabled 1: Enabled		
9.1	[F-01]	Above which outdoor temperature is cooling allowed?	R/W 10~35°C, step: 1°C 20°C		
9.1	[F-02]	--	3		
9.1	[F-03]	--	5		
9.1	[F-04]	--	0		
9.1	[F-05]	--	0		
9.1	[F-09]	Pump operation during flow abnormality.	R/W 0: Disabled 1: Enabled		
9.1	[F-0A]	--	0		
9.1	[F-0B]	Close shut-off valve during thermo OFF?	R/W 0: No 1: Yes		
9.1	[F-0C]	Close shut-off valve during cooling?	R/W 0: No 1: Yes		
9.1	[F-0D]	What is the pump operation mode?	R/W 0: Continuous 1: Sample 2: Request		

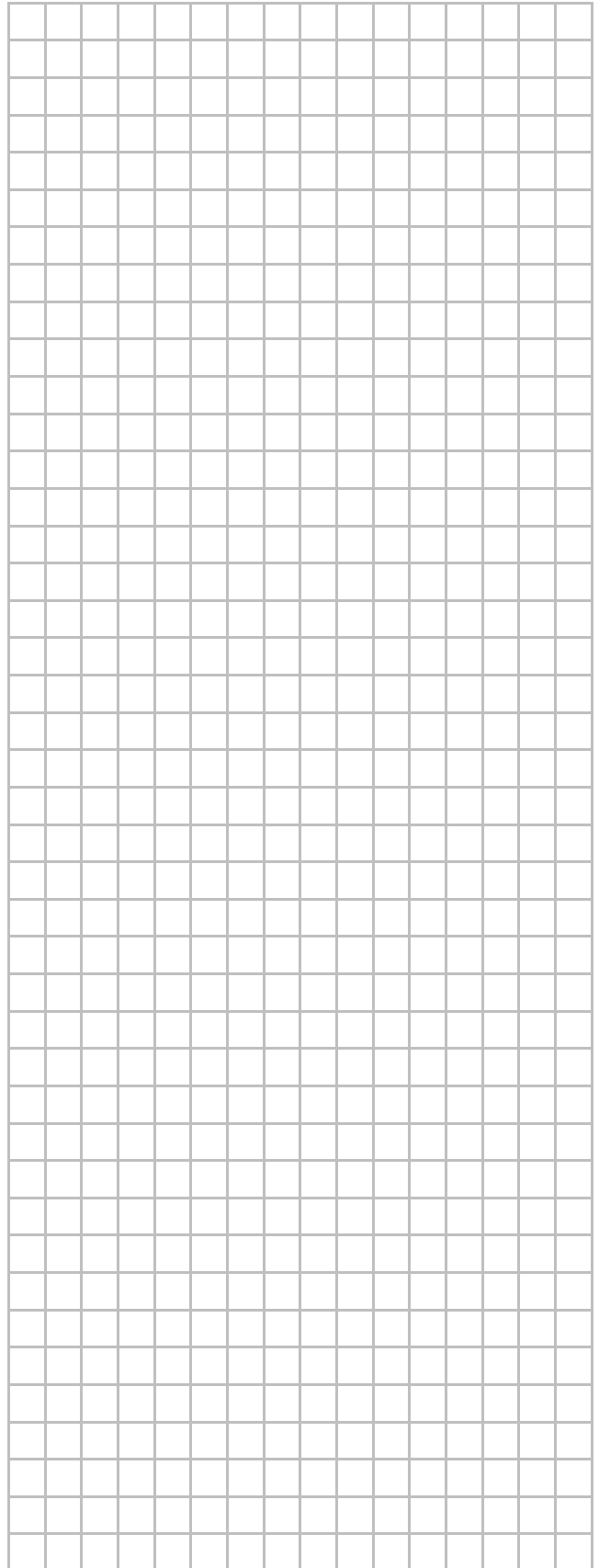
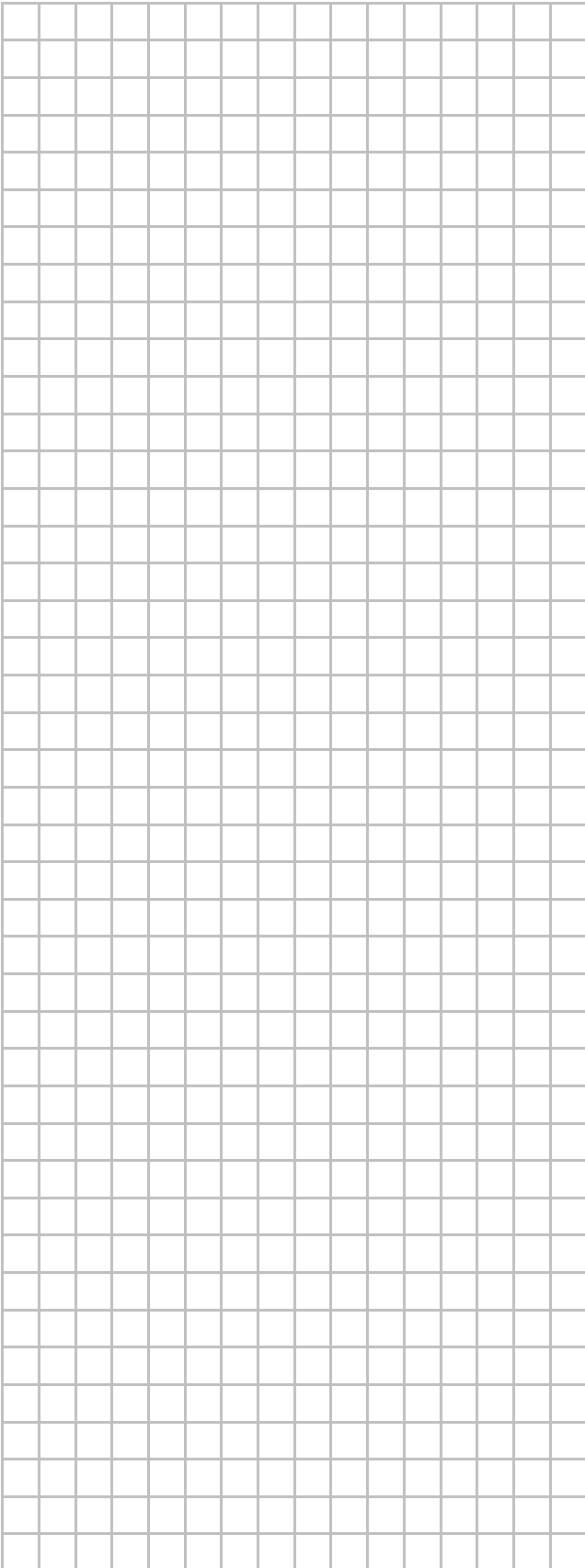

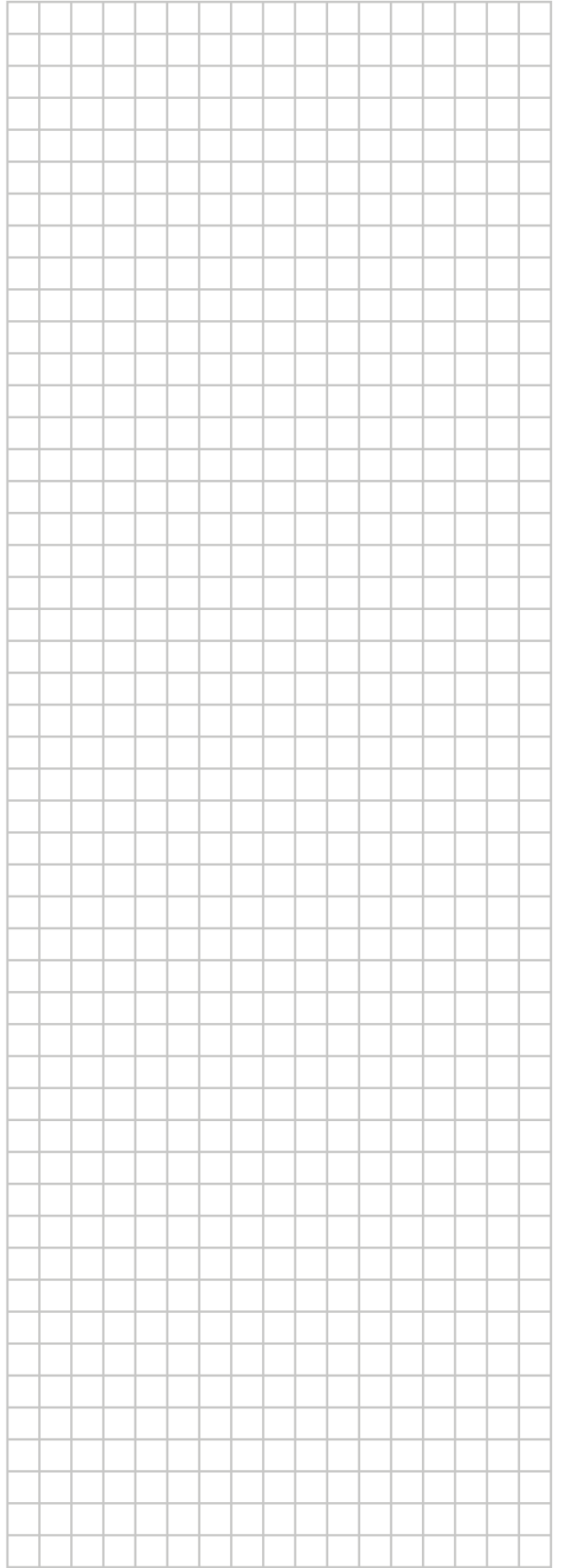
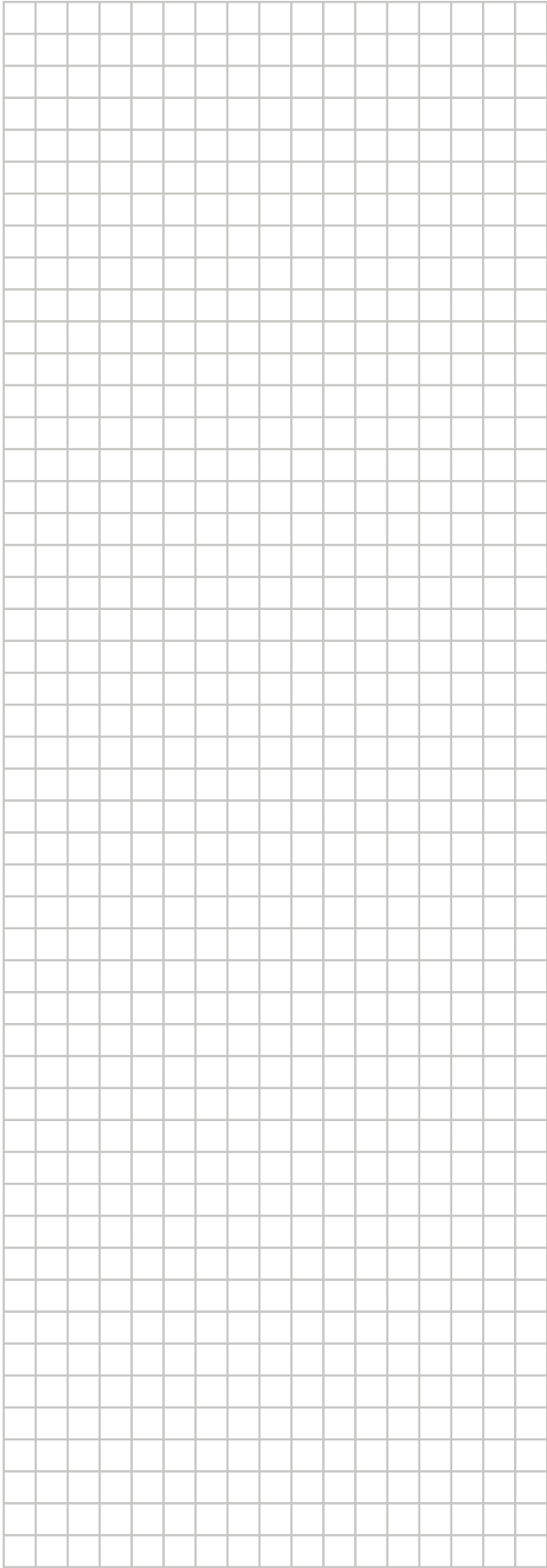

ERC

Copyright 2018 Daikin

DAIKIN EUROPE N.V.
Zandvoordestraat 300, B-8400 Oostende, Belgium

4P556069-1B 2021.09